

# MFOS2 40

drawing the  
transparencies

METALFORM



**METALFORM**

MFOS2 40 + MFOS2 75

# MFOS2 40

The maximum quality in a system reduced to the essentials: MFOS2 40. Designed for interior design projects, the agile and lightweight tubular profiles reproduce the same image of the MFOS2 windows and doors in the glass partitions, creating an effect of continuity between interiors and the building envelope.

**METALFORM**

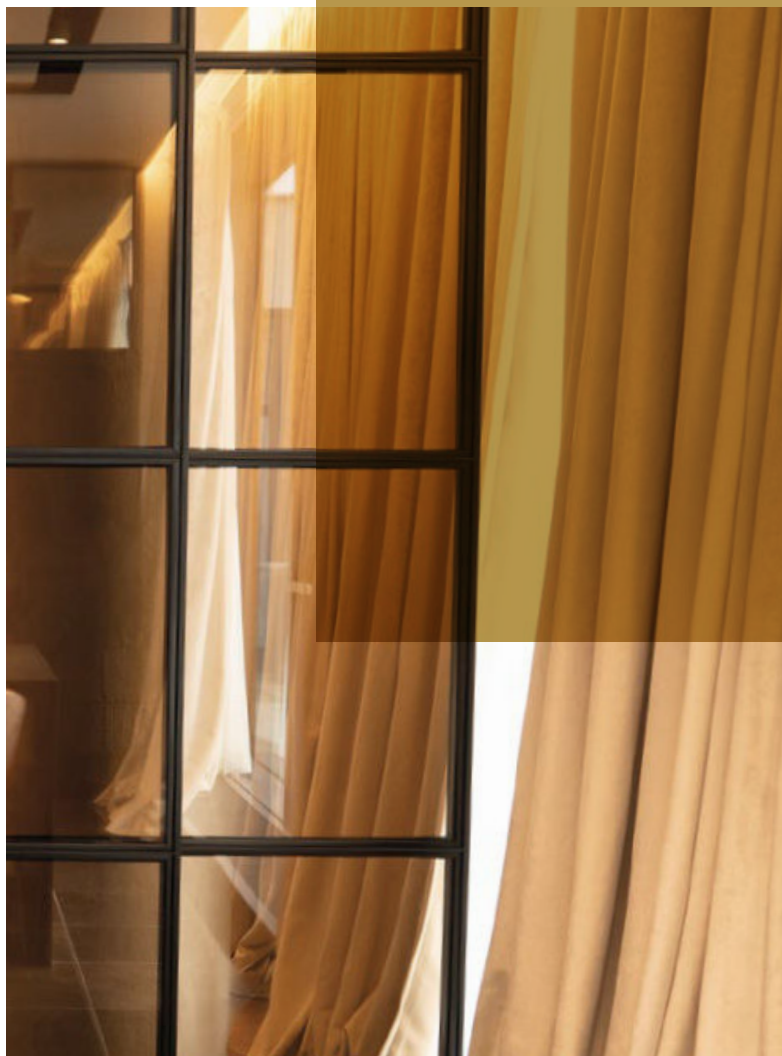

sliding door with single glass

**METALFORM**



double sashes door

**METALFORM**



METALFORM



METALFORM



single sash door  
**METALFORM**





double sashes door  
**METALFORM**

# MFOS2 40

the visible sections range from 12 to 47mm while the depth is reduced to 42mm, for glazing up to 27mm.

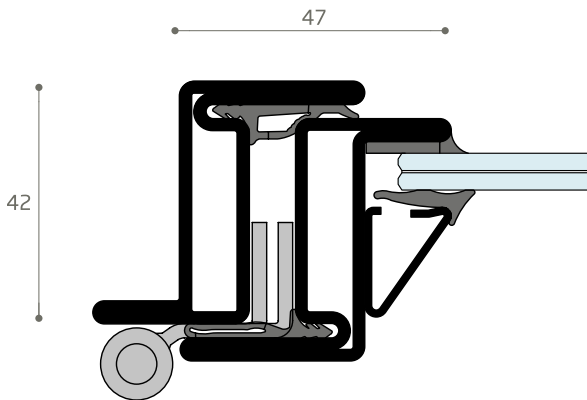

**METALFORM**

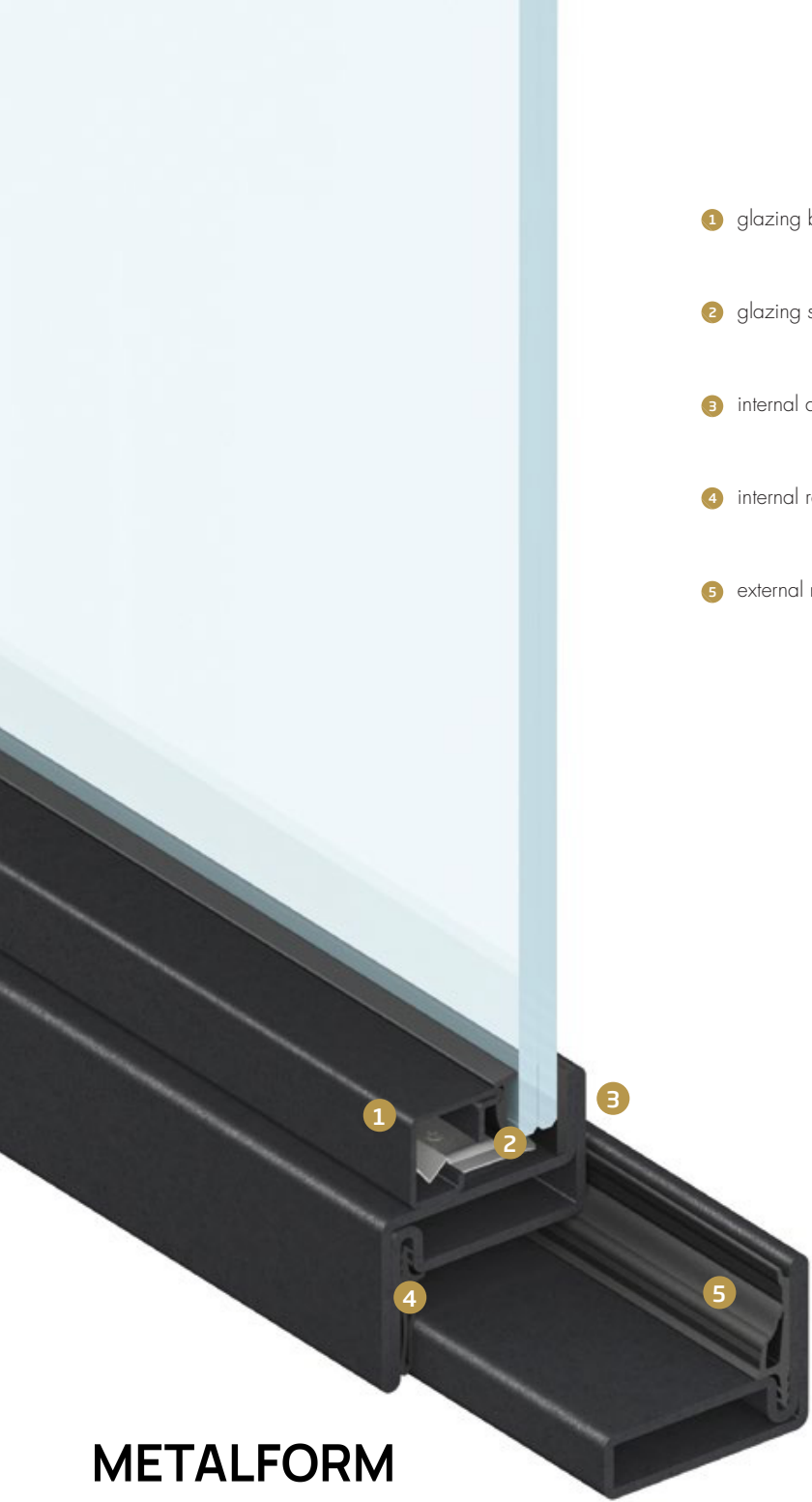

- 1 glazing bead
- 2 glazing slot up to 27mm
- 3 internal and external overlap
- 4 internal rebate gasket
- 5 external rebate gasket

**METALFORM**

# MFOS2 40

## openings doors

inward opening

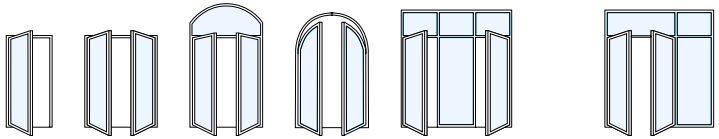

outward opening

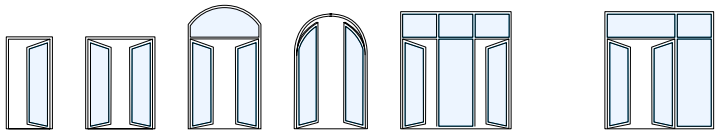

## materials

pickeled steel  
(painted)



**METALFORM**

## handles

### VITRUVIO tronca

finishes

natural brass | burnished | painted

Corten



### VITRUVIO quadra

finishes

natural brass | burnished | painted

Corten



# METALFORM



MFOS2 40 external view

**METALFORM**



MFOS2 40 internal view

**METALFORM**

# MFOS2 40

## sections

inward opening

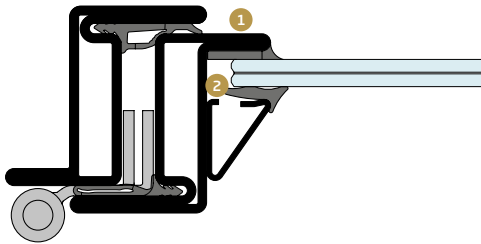

- 1 internal and external overlap
- 2 fitting groove up to 27mm

outward opening

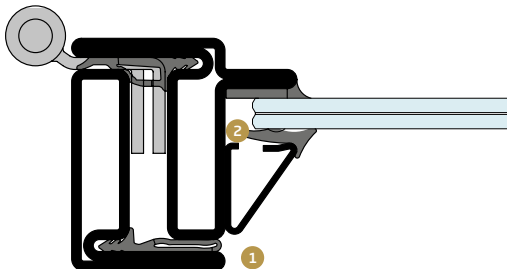

- 1 internal and external overlap
- 2 fitting groove up to 27mm

METALFORM



## profiles

PR2424



PR2425

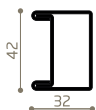

PR2430



PR2431



PR2451

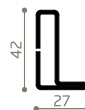

PR2461

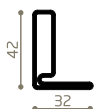

PR2462

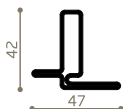

PR2463

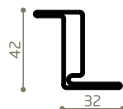

PR2464

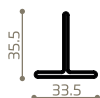

PR2471



PR2454

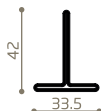

PR2455

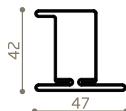

PR2474

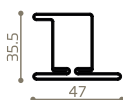

PR2482

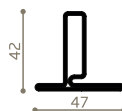

## glazing beads

PR2415



PR2416



PR2429



PR2606



PR2607



# MFOS2 40

## sections

inward opening

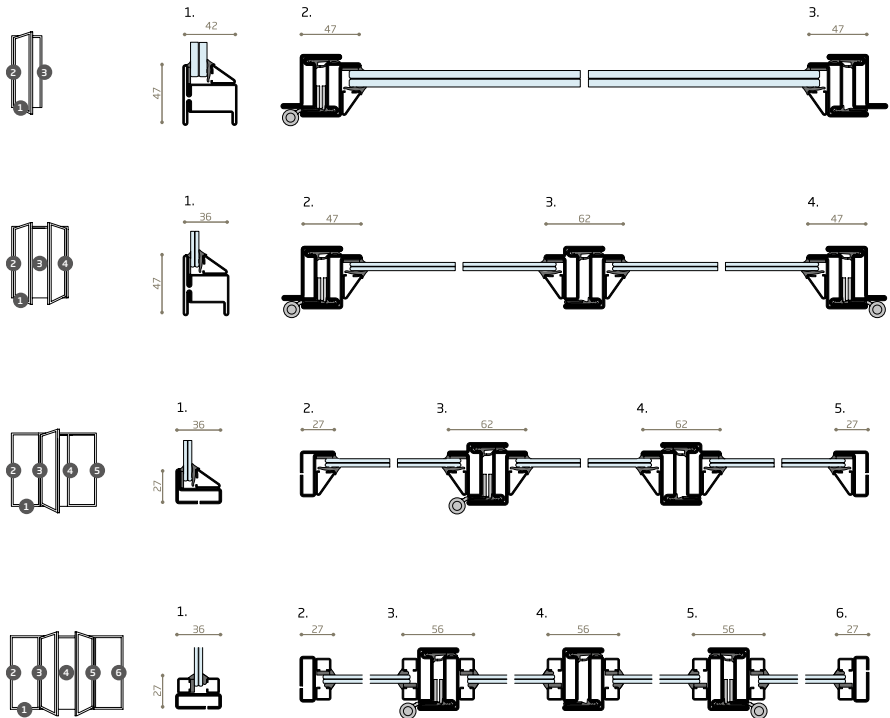

METALFORM

# MFOS2 40

## sections

outward opening

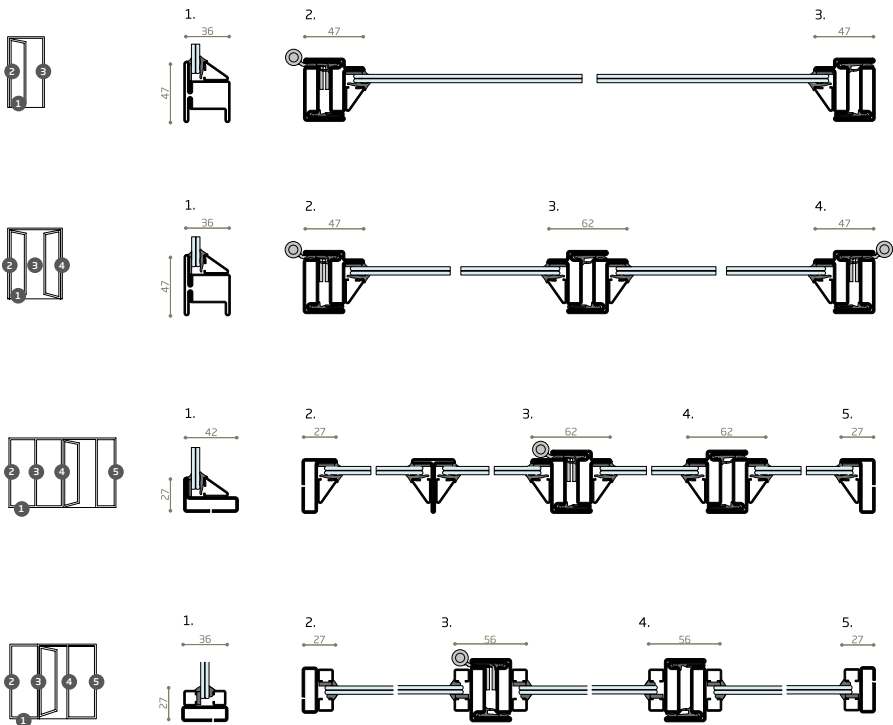

METALFORM



METALFORM



METALFORM



**METALFORM**  
single sash door with  
fixed pane



fix door with divide profile

**METALFORM**

**BESPOKE & *Beautiful***

Let's talk



**METALFORM™**

[www.metalform.uk](http://www.metalform.uk)



# METALFORM

**Metalform is a leader in manufacturing high quality steel and wrought iron products throughout Europe. We are a company with great pride in our products, with highly skilled fabricators and blacksmiths within modern production facilities. For over 20 years we have delivered steel and iron products of the highest quality to our clients all over Europe.**

Metalform produces a complete range of architectural products in steel and wrought iron including windows, doors, partitions, gates, fences, railings, balconies and many other products for your homes and businesses.

# METALFORM

MASTERS OF METAL

**UNITED KINGDOM**

**METALFORM**

**NORWAYMETAL LTD**

53 Chelsea Manor Street

London, SW3 5RZ

**SALES@METALFORM.UK**

**+44 20 81298814**

**GERMANY**

**METALFORM GMBH**

Carl-Zeiss-Ring 15A

85737 Ismaning

**SALES@METALFORMGROUP.DE**

**+49 17663630406**

**NORWAY**

**METALFORM AS**

Brochmannsveien 2

1950 Rømskog

**SALG@METALFORM.NO**

**+47 401 62 446**

**METALFORMGROUP**

**SALES@METALFORMGROUP.COM**