

**EBE 85 ØG**  
CATALOGO  
TECNICO  
TECHNICAL  
CATALOGUE

**METALFORM**  
versione 10/2020







**EBE 85 ØG®** è un sistema integrato di accessori, guarnizioni e profilati a **taglio termico** aventi profondità di 85 mm e sezione in vista di 94 mm, nella versione base, e di 69 mm nella versione ridotta.

I **profili** sono realizzati dall'unione, senza soluzione di continuità, di due gusci metallici (uno intero ed uno esterno), tramite estruso di poliammide caricato in fibra di vetro e reso solidale alle parti da resina poliuretana ad alta densità. I gusci metallici componenti il sistema sono dello spessore di 15/10 mm sono ottenuti da profilatura a freddo di nastri nei vari materiali

La **costruzione dei telai** prevede l'unione tra i profili tramite saldatura in continuo delle sezioni in contatto e la successiva ripresa delle superfici in vista, o l'utilizzo di un sistema misto ad assiemaggio meccanico a saldatura interna che non necessita di riprese di finitura.

Il **sistema** consente di realizzare serramenti alzanti scorrevoli a levitazione magnetica passiva da una a sei ante, apribili e/o fisse, soluzioni con ante alternate fisse e apribili in sequenza, con ante disposte su una, due o tre vie di scorrimento, con soluzione a scomparsa all'interno del muro. Il sistema può installare vetri a doppia camera fino a 55 mm di spessore.

Il sistema a **levitazione magnetica passiva** si compone di un gruppo di levitazione incassato a pavimento che contiene la rotaia di scorrimento, i pattini magnetici Ironlev® e la trave di collegamento con l'anta scorrevole. Il gruppo di levitazione è accessibile per la manutenzione attraverso profili di copertura amovibili che possono contenere, nella loro superficie a vista le stesse finiture del pavimento. A pavimento rimane visibile solo una fessura di 8mm chiusa da spazzolini lungo tutta la larghezza di scorrimento inferiore dell'anta, senza nessun inciampo.

Il sistema consente di poter realizzare ante con peso fino a 1000 kg.

Le prestazioni di tenuta al passaggio di aria e acqua sono ottenute grazie alla compressione dei giunti di tenuta durante la chiusura delle ante mediante il sistema di abbassamento superiore dell'anta atto a contrastare la spinta verticale dei magneti dalla posizione di scorrimento alla posizione di chiusura dell'anta, permettendo la compressione delle guarnizioni di battuta.

Tali giunti sono progettati con doppia guarnizione di tenuta sui quattro lati, accessori per il drenaggio dell'acqua sotto la quota pavimento finito e speciali tamponi in gomma e neoprene posizionati alle estremità verticali del giunto centrale.

Ogni tipologia è provvista di apposita accessoristica di movimentazione e chiusura a scomparsa ed integrata al sistema con chiusure multiple: tutte le soluzioni possono essere motorizzate tramite l'installazione dei gruppi motore, dedicati e a scomparsa, che ne consentono l'alzata e lo scorrimento.

Le prestazioni del sistema a taglio termico **EBE 85 ØG®** sono state testate, nelle configurazioni più estreme di peso e dimensione, dai migliori Laboratori di certificazione Europei secondo le norme di riferimento EN 14351-1.

**EBE 85 ØG®** is an integrated system of accessories, gaskets and **thermally broken** cold-rolled profiles with a nominal depth of 85 mm and visible section of 94 mm, in the standard version, or 69 mm in the reduced one.

**The profiles** are made by joining two metal shells (one internal and one external) by means of extruded polyamide reinforced with fibre-glass and joined to the parts by high density polyurethane resin injected at high pressure. The metal profiles that make up the system are 15/10 mm thick and are obtained from the cold-forming of the coils in the various materials available.

**For frame assembly the profiles** must be joined by continuous welding the sections in contact with each other and the subsequent grinding on the exposed surfaces, and or by mechanically assembling and then internally welding which does not need finishing touches.

**The system** allows the manufacture of lift-and-slide doors with passive magnetic levitation system with up to six sashes openable and/or fixed, in the configurations of alternating sequence of fixed and openable leaves bi-parting solutions, with one, two or three sliding ways, with concealed solution inside the wall. The system can be fitted with an IGU up to 55 mm thick.

**The passive magnetic levitation** system is composed with a levitation group insert under the floor that is composed by the sliding rail, Ironlev® magnetic pads and a connection beam to the sash frame. The system is accessible for maintenance through removable capping profiles that can be fitted with the same finishes of the floor. Only an 8mm gap, sealed with brushes, remains visible along the all length of the door, avoiding any possible tripping.

The system allows to realize sash with weight up to 1000 kg.

High performance of the system in terms of air permeability, watertightness is achieved thanks to the compression provided by the sealing joints in closing position with the lowering system located on the upper side of the sash. The lowering system counteract the vertical lifting thrust of the magnets from the sliding position to the closing position of the sash, allowing the compression of the gasket.

These joints are designed with double sealing gaskets along all four sides, a dedicated accessory for the water drainage and special rubber and neoprene pads positioned at the top of the central joint.

Each typology comes with a dedicated set of accessories for concealed handling and multi-locking system: all configurations can be automated by means of dedicated and concealed motor units, which allow the lifting and sliding of the system.

The performances of the thermally broken system **EBE 85 ØG®** have been tested in the most extreme configurations of weight and size from the best European certification laboratories according to the reference standards EN 14351-1.

#### PRESTAZIONI

Trasmittanza termica (UNI EN 14351/1)

- Uw fino a 1,1 W/m<sup>2</sup>K

Resistenza all'aria (UNI EN 12207)

- fino a classe 4

Resistenza all'acqua (UNI EN 12208)

- fino a classe 9A

Resistenza al vento (UNI EN 12210)

- fino a classe B3

Forze di azionamento (UNI EN 12046/1)

- Classe 1 < 100 N

#### PERFORMANCE

Thermal transmittance (UNI EN 14351/1)

- Uw up to 1,1 W/m<sup>2</sup>K

Air permeability (UNI EN 12207)

-up to class 4

Watertightness (UNI EN 12208)

-up to class 9A

Resistance to wind load (UNI EN 12210)

- up to class B3

Operating forces (UNI EN 12046/1)

- Class 1 < 100 N

## Test ITT

|   |   |
|---|---|
| <b>Campione testato / Test specimen</b>                         | Alzante scorrevole a due ante apribili<br><i>Double leaf lifting sliding door</i> |
| <b>Materiale / Material</b><br><b>Sistema / System</b>          | Ottone / Brass<br>Profili ridotti / <i>Small profiles</i>                         |
| <b>Dimensioni / Dimensions</b>                                  | Telaio / <i>Frame</i> 3764 x 3472 mm<br>Anta / <i>Sash</i> 1900 x 3430 mm         |
| <b>Peso anta / Sash weight</b>                                  | 600 Kg  |
| <b>Forza di scorrimento / Operating forces</b><br>(EN12046/1)   | Classe / <i>Class</i> 1 (< 100 Nm)  |
| <b>Permeabilità all'aria / Air permeability</b><br>(EN 12207)   | Classe / <i>Class</i> 4   |
| <b>Tenuta all'acqua / Watertightness</b><br>(EN 12208)          | Classe / <i>Class</i> 9A  |
| <b>Resistenza al vento / Wind load resistance</b><br>(EN 12210) | Classe / <i>Class</i> B3  |



Schema | Type A

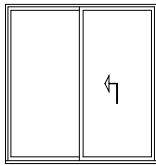

Schema | Type B

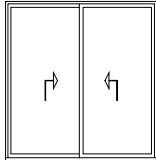

Schema | Type C

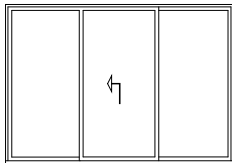

Schema | Type E

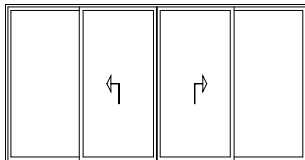

Schema | Type F

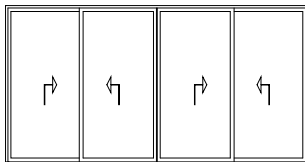

Schema | Type S1

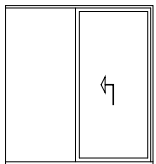

Schema | Type S2

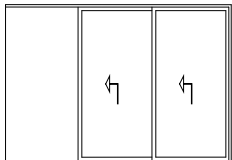

Schema | Type S3

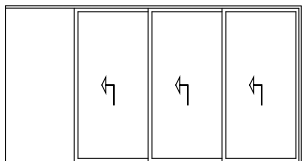

Schema | Type A3

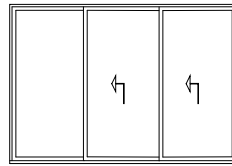

Schema | Type B3

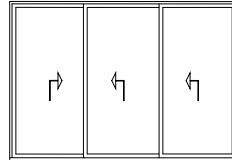

Schema | Type C3

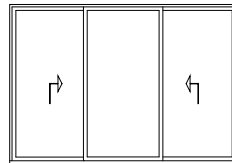

Schema | Type E3

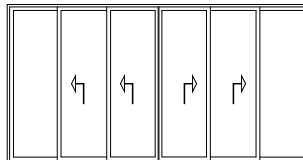

Schema | Type F3

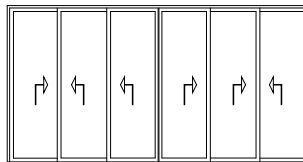

Schema | Type T1

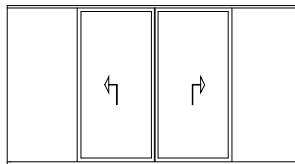

Schema | Type T2

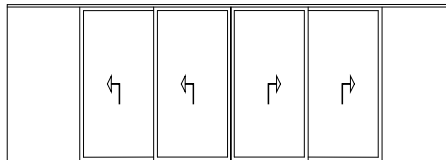

Schema | Type T3

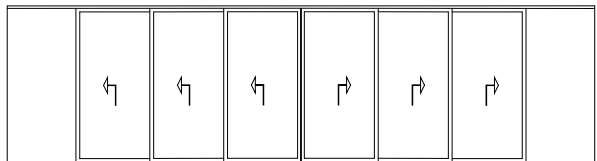

Schema | Type A 1 anta scorrevole ed 1 anta fissa  
1 sliding and 1 fixed sash

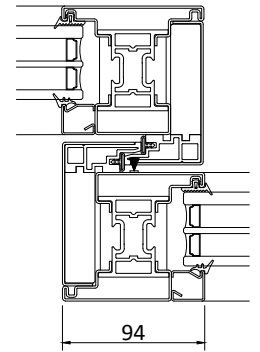
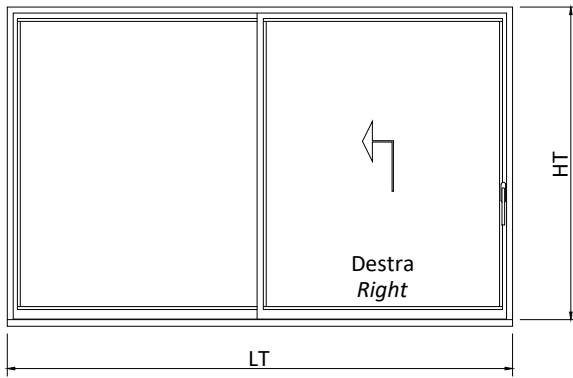

Schema | Type B 2 ante scorrevoli  
2 sliding sashes

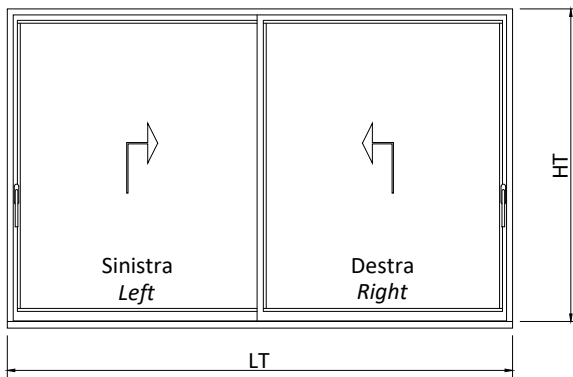

Limiti dimensionali | Dimensional limits (mm)

|                |    |              |         |
|----------------|----|--------------|---------|
| Telaio   Frame | LT | 1564 - 3764  | LT      |
|                | HT | 2407 - 3472  | HT      |
| Anta   Sash    | LA | 800 - 1900*  | LT/2+18 |
|                | HA | 2365 - 3430* | HT - 42 |

fino a | up to  
1000 kg\*\*

\* rif. dimensioni del campione sottoposto a test di tenuta aria, acqua, vento  
ref. dimensions of the door tested to air, water and wind resistant  
\*\* vedi capitolo 2.3  
see chapter 2.3

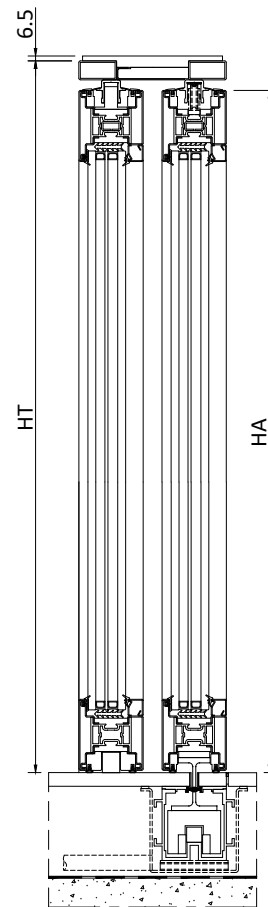

Schema | Type A

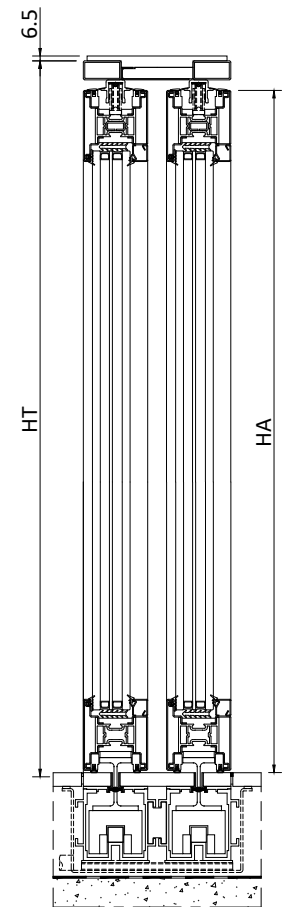

Schema | Type B

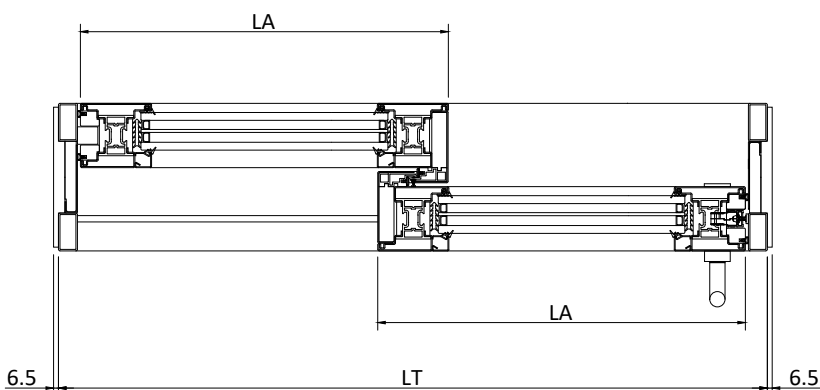



Schema | Type E 2 ante scorrevoli e 2 ante fisse  
2 sliding and 2 fixed sashes

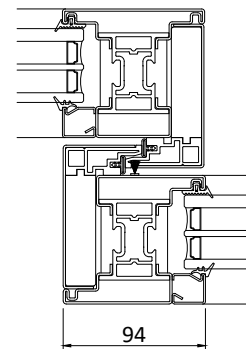
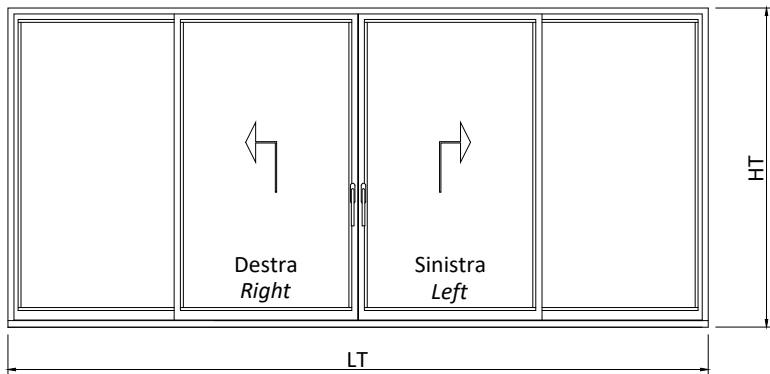

Schema | Type F 4 ante scorrevoli  
4 sliding sashes

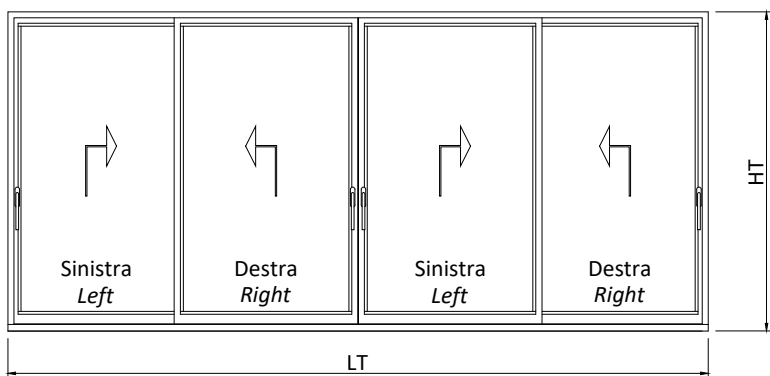

Limiti dimensionali | Dimensional limits (mm)

|                |    |              |         |
|----------------|----|--------------|---------|
| Telaio   Frame | LT | 3074 - 7474  | LT      |
|                | HT | 2407 - 3472  | HT      |
| Anta   Sash    | LA | 800 - 1900*  | LT/4+41 |
|                | HA | 2365 - 3430* | HT - 42 |

fino a | up to 1000 kg\*\*

\* rif. dimensioni del campione sottoposto a test di tenuta aria, acqua, vento  
ref. dimensions of the door tested to air, water and wind resistant

\*\* vedi capitolo 2.3  
see chapter 2.3

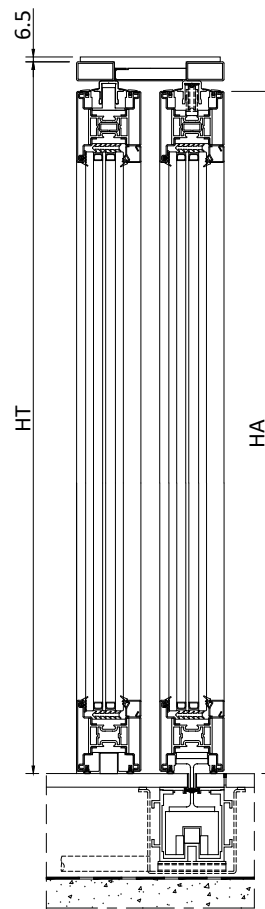

Schema | Type E

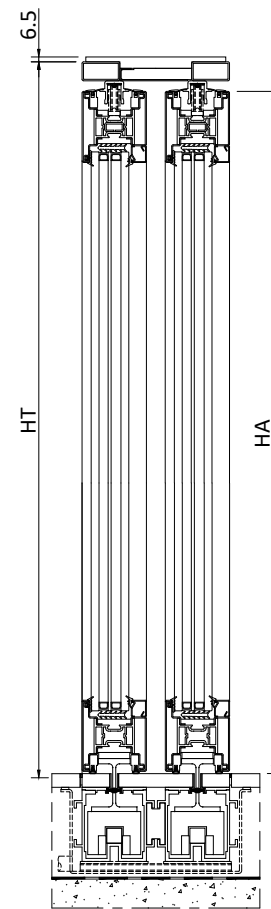

Schema | Type F

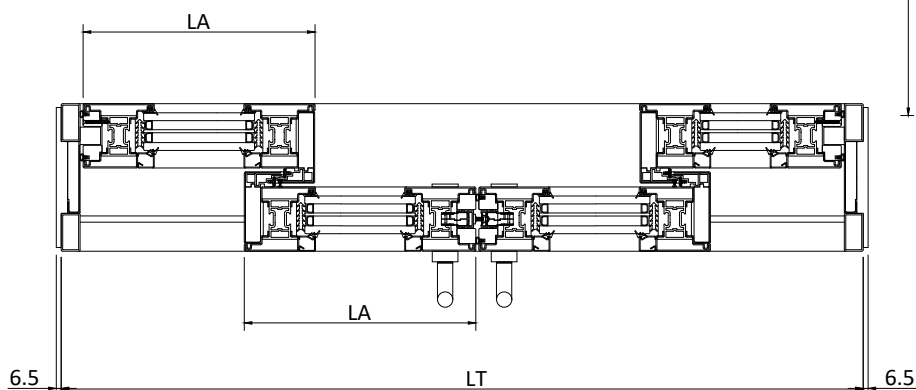

Schema | Type A3 2 ante scorrevoli ed 1 anta fissa  
2 sliding and 1 fixed sash

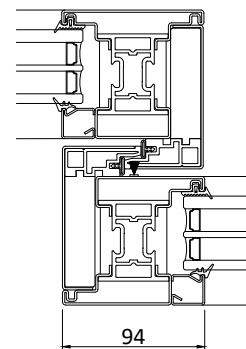
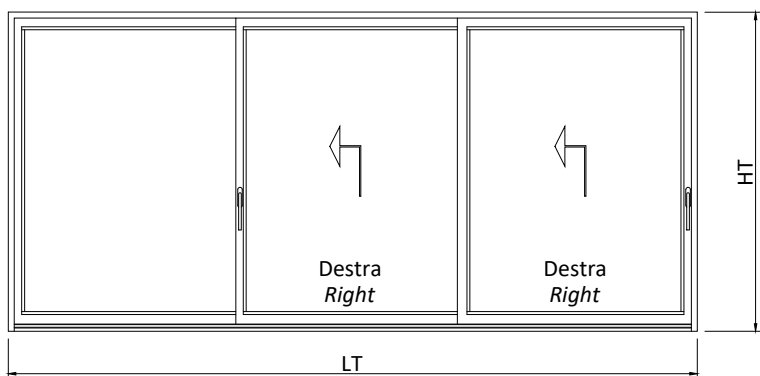

Schema | Type B3 3 ante scorrevoli  
3 sliding sash

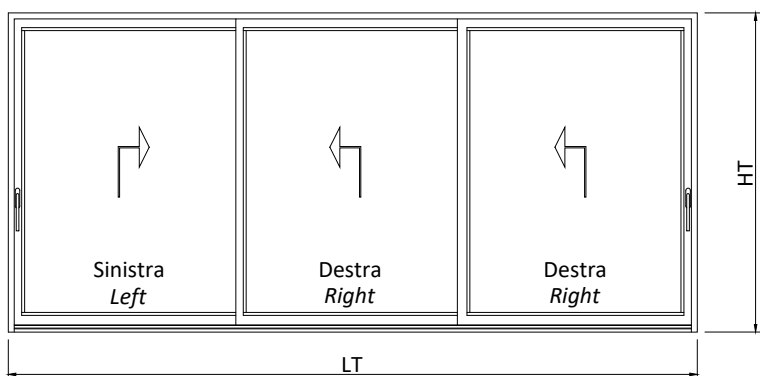

Limiti dimensionali | Dimensional limits (mm)

|                |    |              |         |
|----------------|----|--------------|---------|
| Telaio   Frame | LT | 2270 - 5570  | LT      |
|                | HT | 2407 - 3472  | HT      |
| Anta   Sash    | LA | 800 - 1900*  | LT/3+43 |
|                | HA | 2365 - 3430* | HT - 42 |

fino a | up to  
1000 kg\*\*

\* rif. dimensioni del campione sottoposto a test di tenuta aria, acqua, vento  
ref. dimensions of the door tested to air, water and wind resistant

\*\* vedi capitolo 2.3  
see chapter 2.3

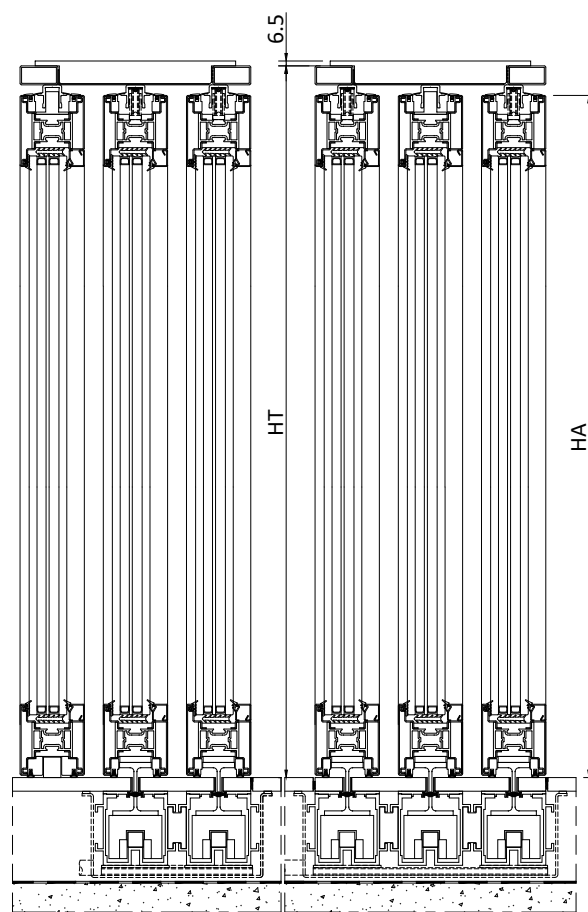

Schema | Type A3

Schema | Type B3

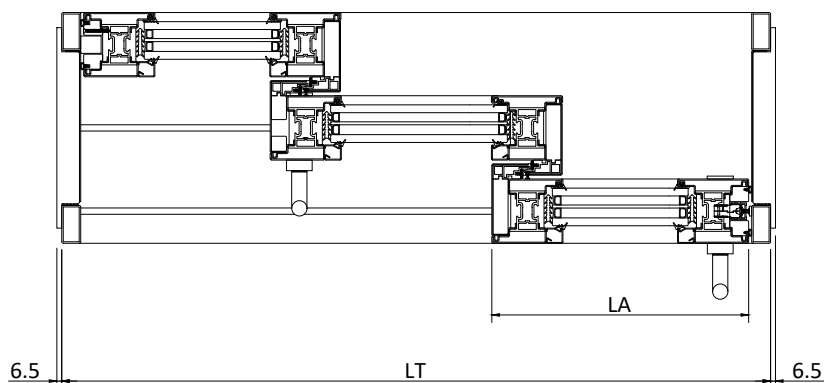

Schema | Type C3 2 ante scorrevoli ed 1 anta fissa  
2 sliding and 1 fixed sash

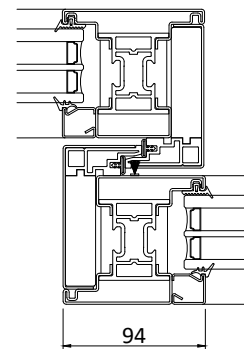
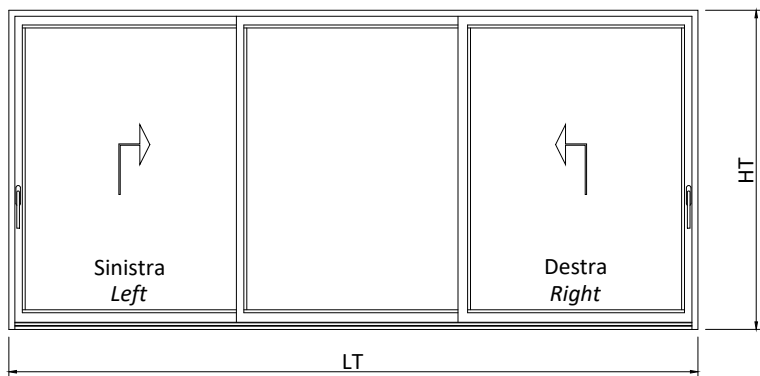

Limiti dimensionali | Dimensional limits (mm)

|                |    |              |         |
|----------------|----|--------------|---------|
| Telaiο   Frame | LT | 2270 - 5570  | LT      |
|                | HT | 2407 - 3472  | HT      |
| Anta   Sash    | LA | 800 - 1900*  | LT/3+43 |
|                | HA | 2365 - 3430* | HT - 42 |

fino a | up to  
1000 kg\*\*

\* rif. dimensioni del campione sottoposto a test di tenuta aria, acqua, vento  
ref. dimensions of the door tested to air, water and wind resistant

\*\* vedi capitolo 2.3  
see chapter 2.3

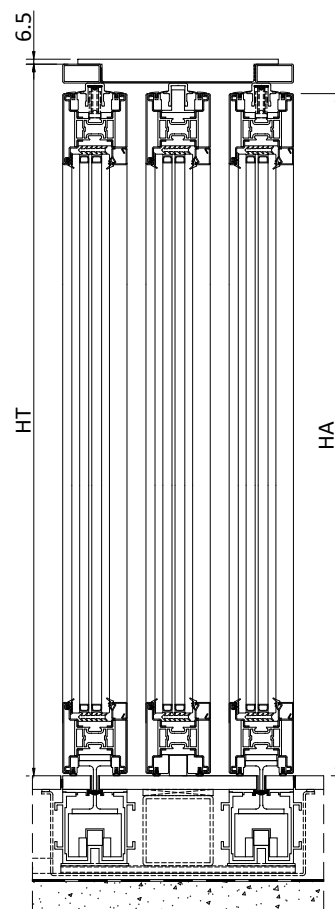

Schema | Type C3

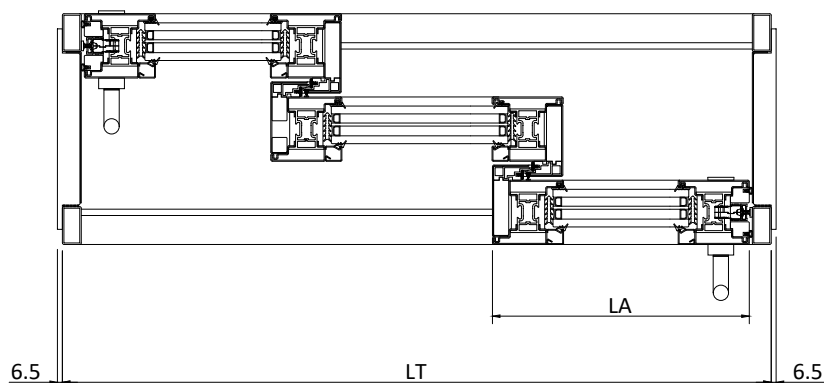

Schema | Type E3 3 ante scorrevoli e 2 ante fisse  
4 sliding and 2 fixed sashes

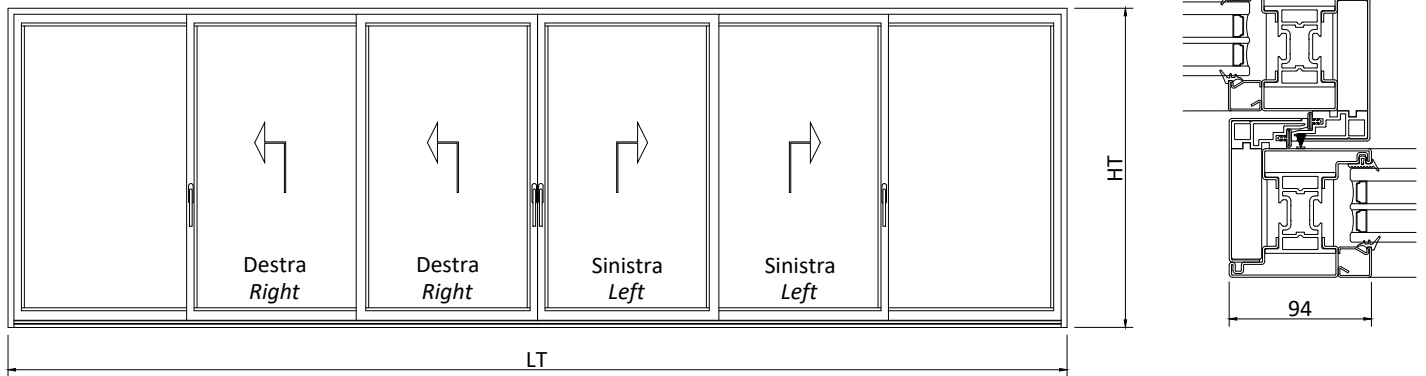

Schema | Type F3 6 ante scorrevoli  
6 sliding sashes

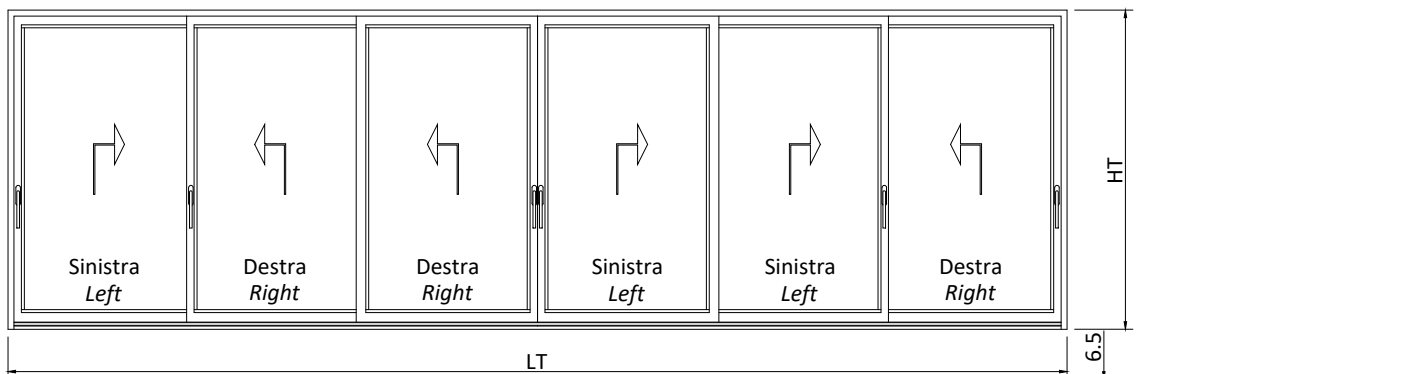

Limiti dimensionali | Dimensional limits (mm)

|                |    |              |         |
|----------------|----|--------------|---------|
| Telaiο   Frame | LT | 4486 - 11086 | LT      |
|                | HT | 2407 - 3472  | HT      |
| Anta   Sash    | LA | 800 - 1900*  | LT/6+52 |
|                | HA | 2365 - 3430* | HT - 42 |

fino a | up to  
1000 kg\*\*

\* rif. dimensioni del campione sottoposto a test di tenuta aria, acqua, vento  
ref. dimensions of the door tested to air, water and wind resistant

\*\* vedi capitolo 2.3  
see chapter 2.3

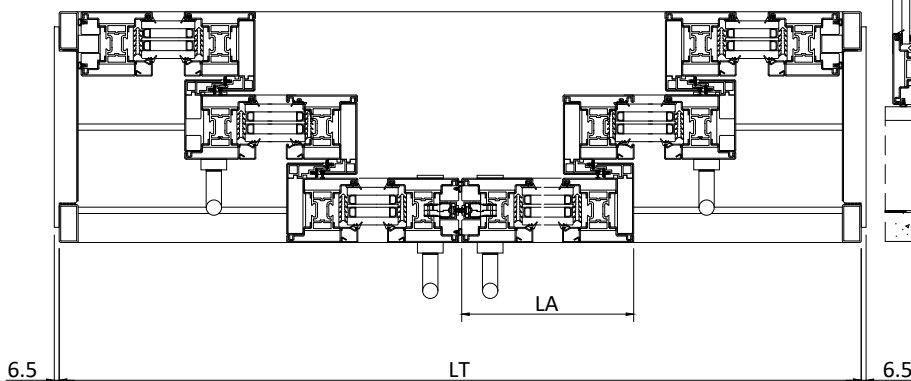
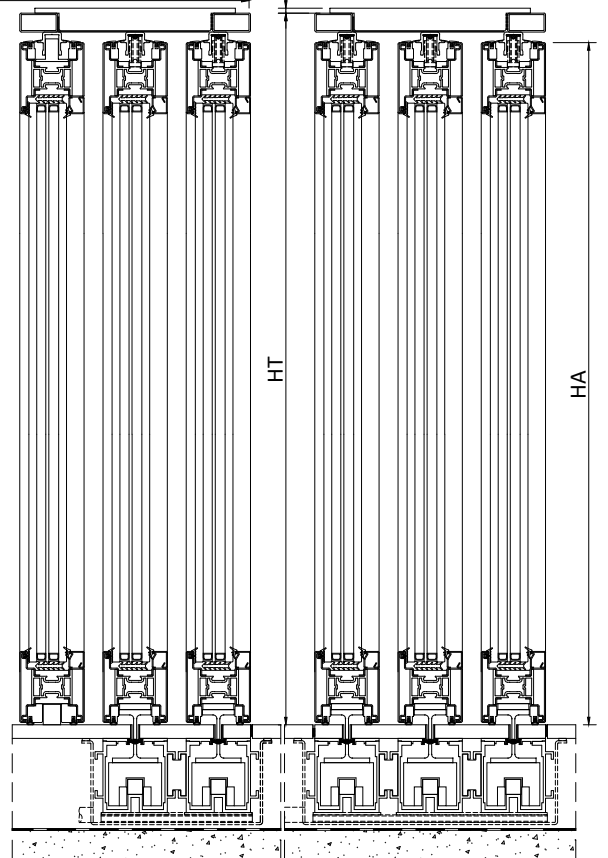

Schema | Type E

Schema | Type F

Schema | Type S1 1 anta scorrevole a scomparsa  
1 sliding sash into the wall

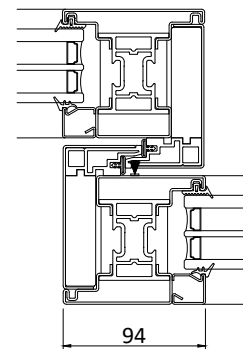
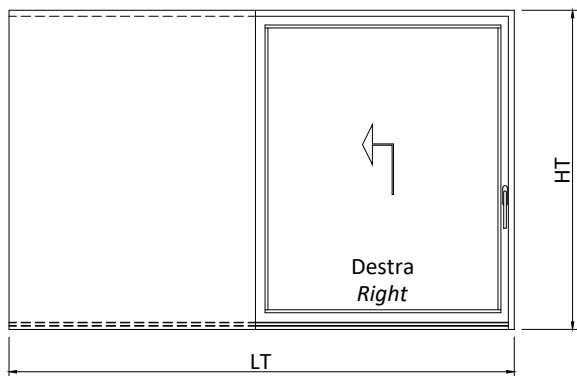

Limiti dimensionali | Dimensional limits (mm)

|                |    |              |                             |
|----------------|----|--------------|-----------------------------|
| Telaiο   Frame | LT | 1564 - 3764  | LT                          |
|                | HT | 2407 - 3472  | HT                          |
| Anta   Sash    | LA | 800 - 1900*  | fino a   up to<br>1000 kg** |
|                | HA | 2365 - 3430* |                             |

\* rif. dimensioni del campione sottoposto a test di tenuta aria, acqua, vento  
ref. dimensions of the door tested to air, water and wind resistant

\*\* vedi capitolo 2.3  
see chapter 2.3

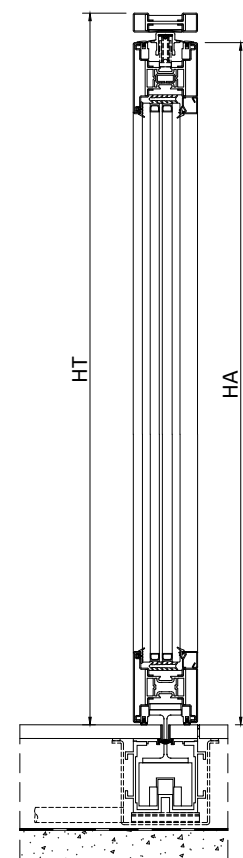
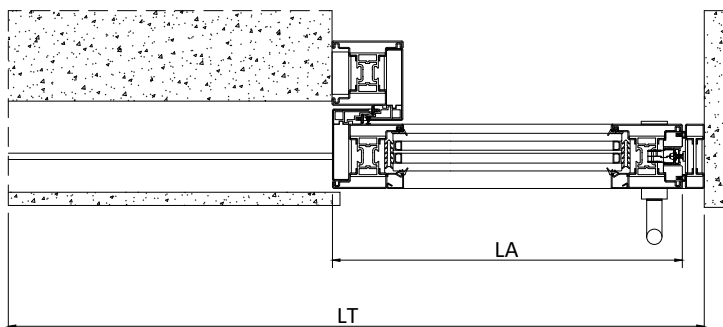

Schema | Type S

Schema | Type S2 2 ante scorrevoli a scomparsa  
2 sliding sashes into the wall

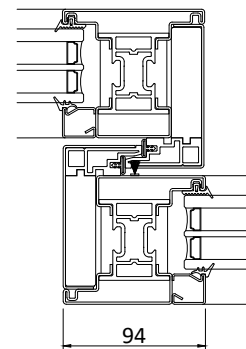
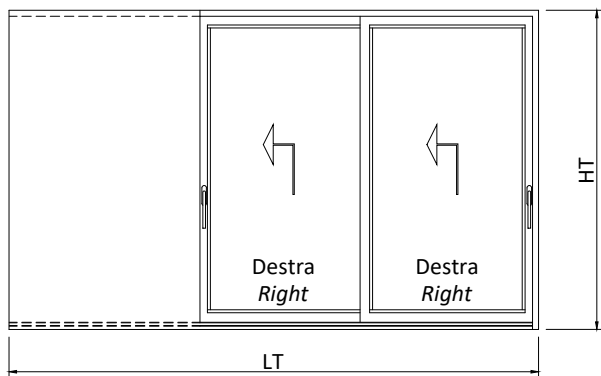

Limiti dimensionali | Dimensional limits (mm)

|                |    |              |                             |
|----------------|----|--------------|-----------------------------|
| Telaiο   Frame | LT | 2270 - 5570  | LT                          |
|                | HT | 2407 - 3472  | HT                          |
| Anta   Sash    | LA | 800 - 1900*  | fino a   up to<br>1000 kg** |
|                | HA | 2365 - 3430* |                             |

\* rif. dimensioni del campione sottoposto a test di tenuta aria, acqua, vento  
ref. dimensions of the door tested to air, water and wind resistant

\*\* vedi capitolo 2.3  
see chapter 2.3

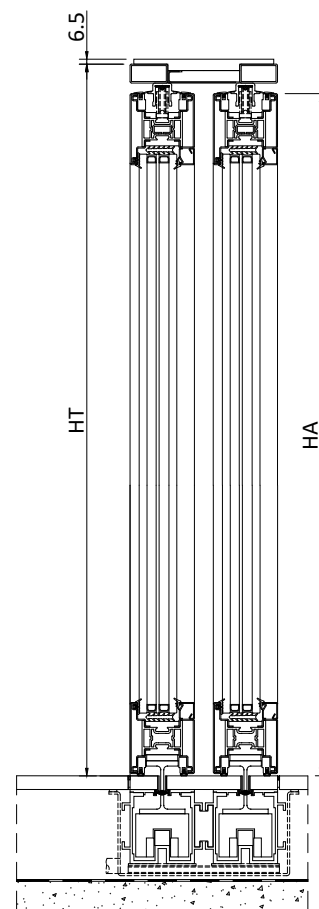
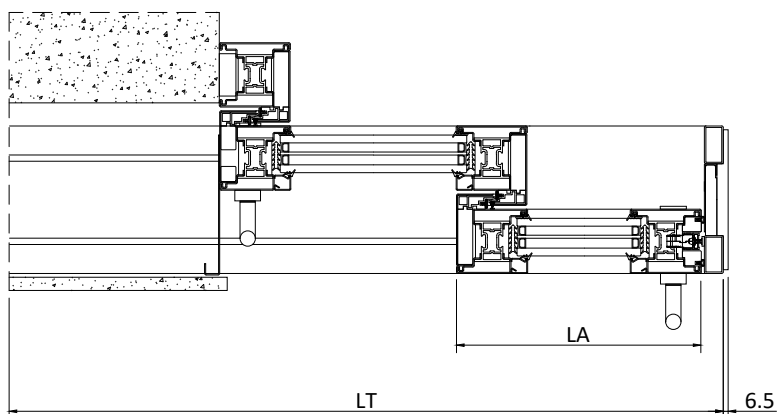

Schema | Type S2

Schema | Type S3 3 ante scorrevoli a scomparsa  
3 sliding sashes into the wall

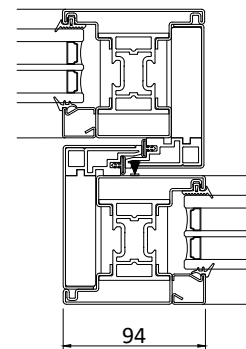
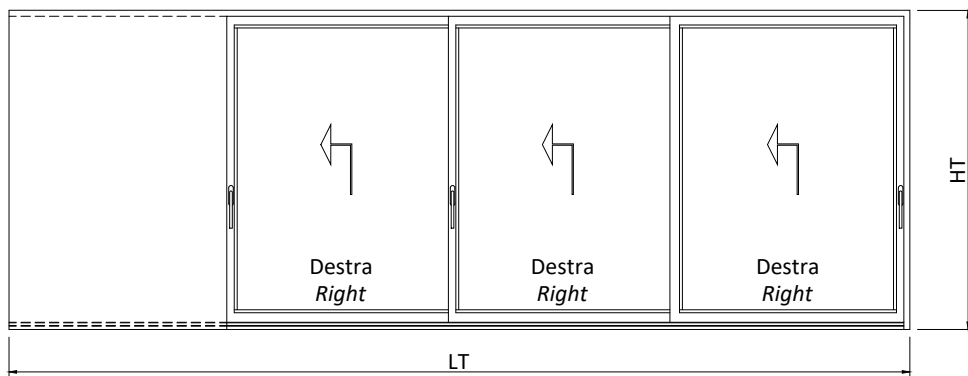

Limiti dimensionali | Dimensional limits (mm)

|                |    |              |                             |
|----------------|----|--------------|-----------------------------|
| Telaio   Frame | LT | 2976 - 7376  | LT                          |
|                | HT | 2407 - 3472  | HT                          |
| Anta   Sash    | LA | 800 - 1900*  | fino a   up to<br>1000 kg** |
|                | HA | 2365 - 3430* |                             |

\* rif. dimensioni del campione sottoposto a test di tenuta aria, acqua, vento  
ref. dimensions of the door tested to air, water and wind resistant

\*\* vedi capitolo 2.3  
see chapter 2.3

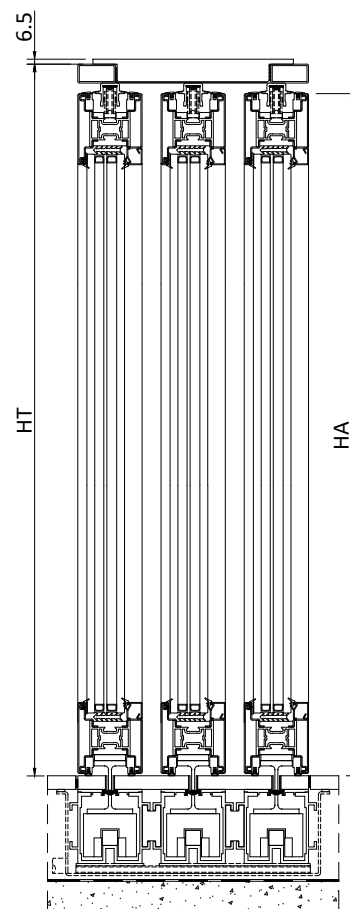
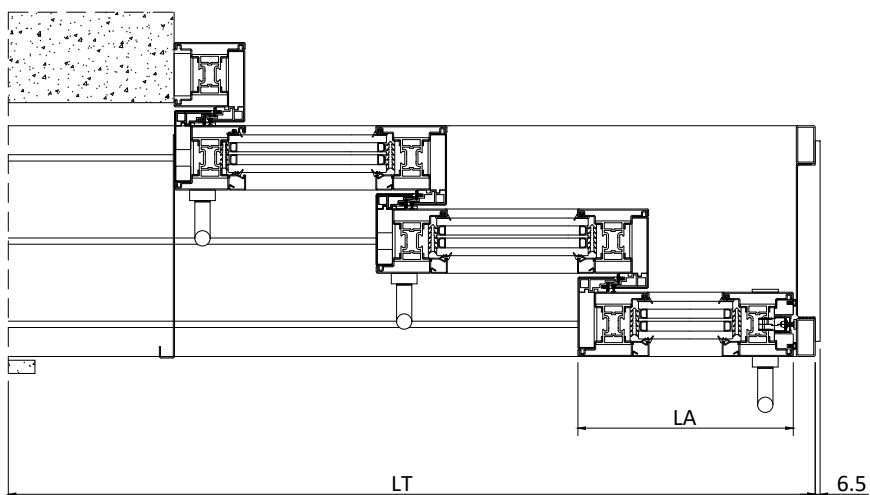

Schema | Type S

Schema | Type T1 2 ante scorrevoli coassiali a scomparsa  
2 coaxial sliding sashes into the wall

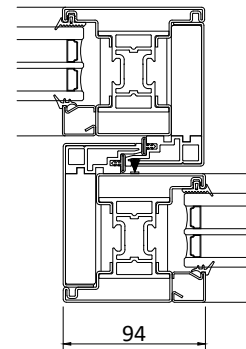
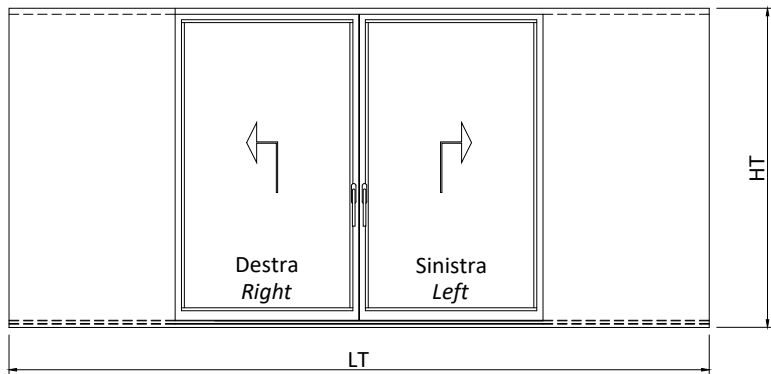

Limiti dimensionali | Dimensional limits (mm)

|                |    |              |                             |
|----------------|----|--------------|-----------------------------|
| Telaiο   Frame | LT | 3074 - 7474  | LT                          |
|                | HT | 2407 - 3472  | HT                          |
| Anta   Sash    | LA | 800 - 1900*  | fino a   up to<br>1000 kg** |
|                | HA | 2365 - 3430* |                             |

\* rif. dimensioni del campione sottoposto a test di tenuta aria, acqua, vento  
ref. dimensions of the door tested to air, water and wind resistant

\*\* vedi capitolo 2.3  
see chapter 2.3

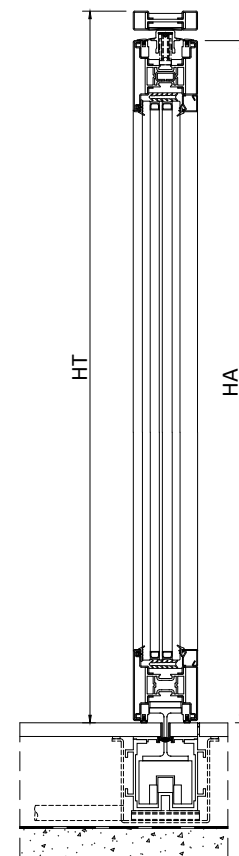
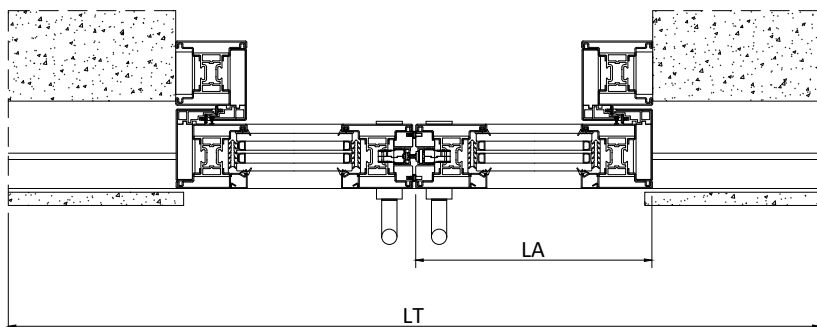

Schema | Type SC



Schema | Type T2 4 ante scorrevoli coassiali a scomparsa  
4 coaxial sliding sashes into the wall

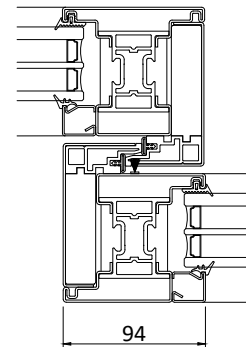
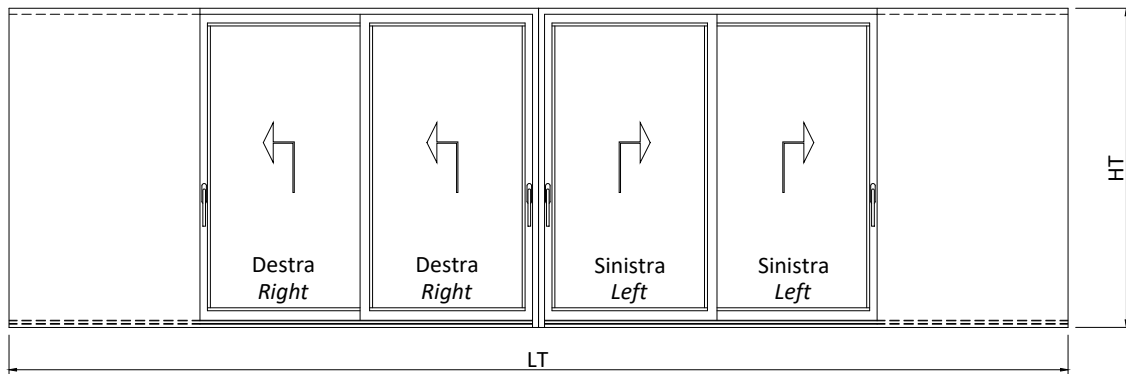

Limiti dimensionali | Dimensional limits (mm)

|                |    |              |                             |
|----------------|----|--------------|-----------------------------|
| Telaiο   Frame | LT | 4486 - 11086 | LT                          |
|                | HT | 2407 - 3472  | HT                          |
| Anta   Sash    | LA | 800 - 1900*  | fino a   up to<br>1000 kg** |
|                | HA | 2365 - 3430* |                             |

\* rif. dimensioni del campione sottoposto a test di tenuta aria, acqua, vento  
ref. dimensions of the door tested to air, water and wind resistant

\*\* vedi capitolo 2.3  
see chapter 2.3

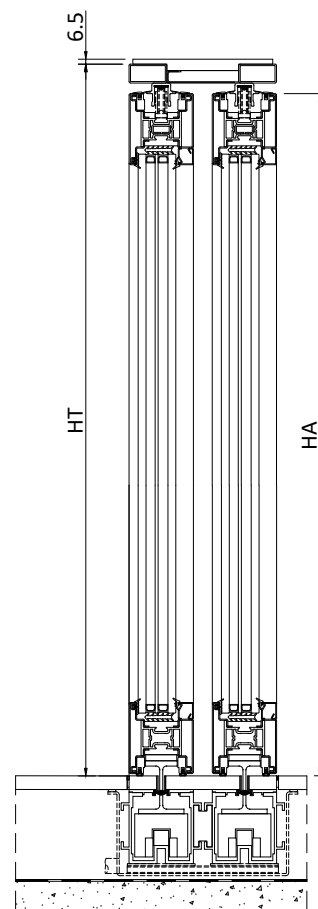
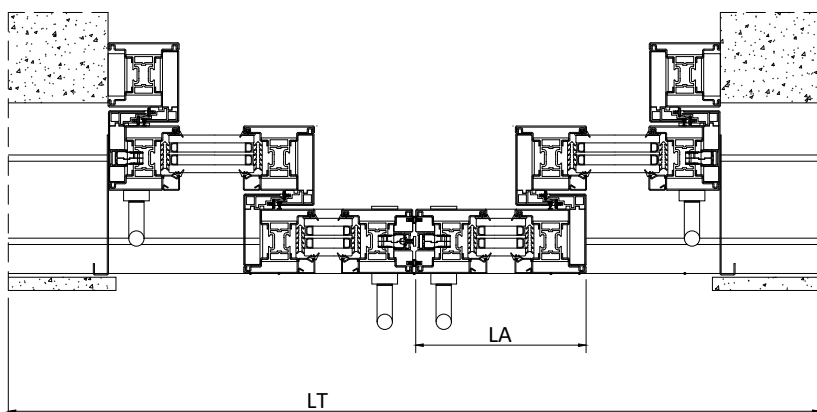

Schema | Type SC2

Schema | Type T3 6 ante scorrevoli coassiali a scomparsa  
6 coaxial sliding sashes into the wall

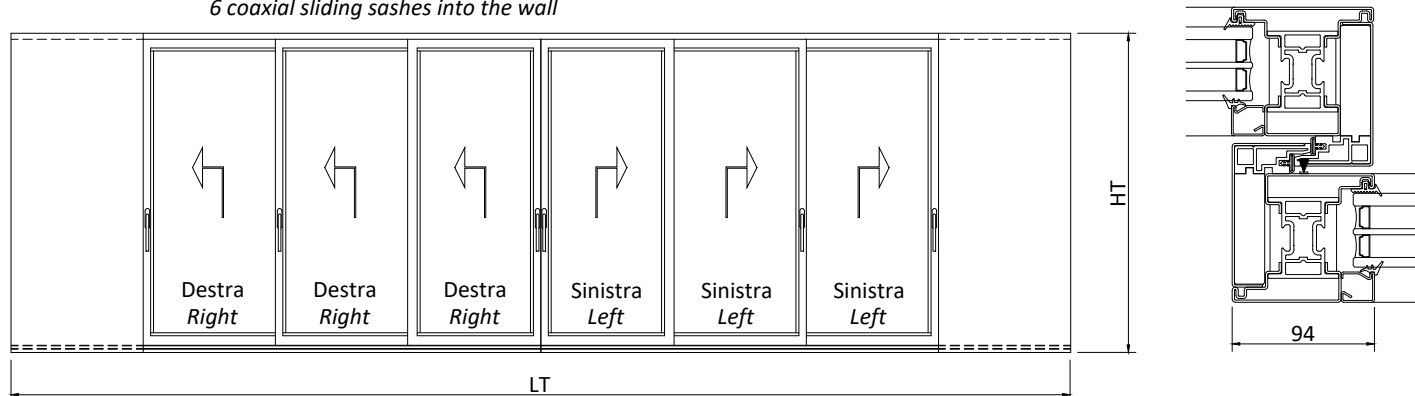

Limiti dimensionali | Dimensional limits (mm)

|                |    |              |                             |
|----------------|----|--------------|-----------------------------|
| Telaio   Frame | LT | 5898 - 14698 | LT                          |
|                | HT | 2407 - 3472  | HT                          |
| Anta   Sash    | LA | 800 - 1900*  | fino a   up to<br>1000 kg** |
|                | HA | 2365 - 3430* |                             |

\* rif. dimensioni del campione sottoposto a test di tenuta aria, acqua, vento  
ref. dimensions of the door tested to air, water and wind resistant

\*\* vedi capitolo 2.3  
see chapter 2.3

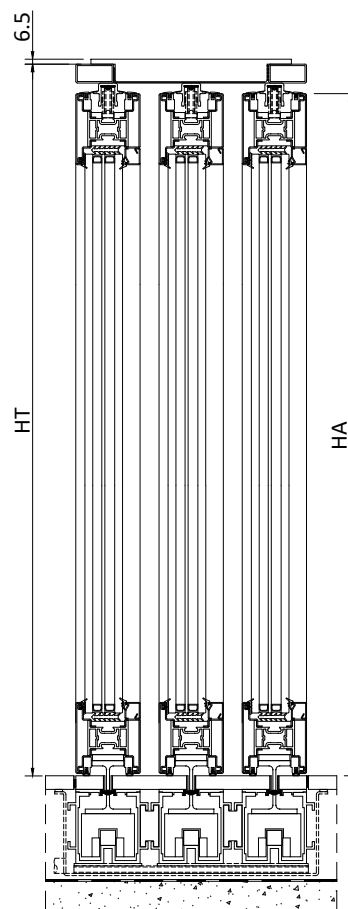
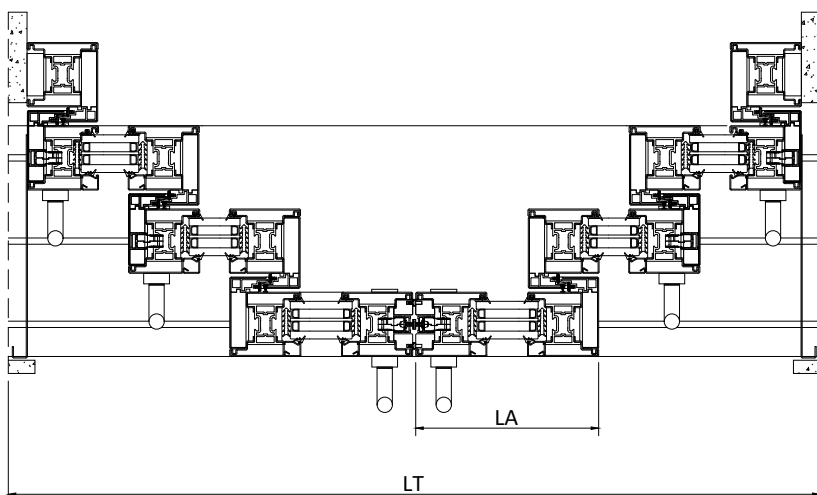

Schema | Type SC

Schema | Type A 1 anta scorrevole ed 1 anta fissa  
1 sliding and 1 fixed sash

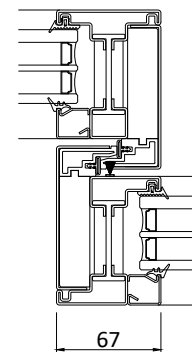
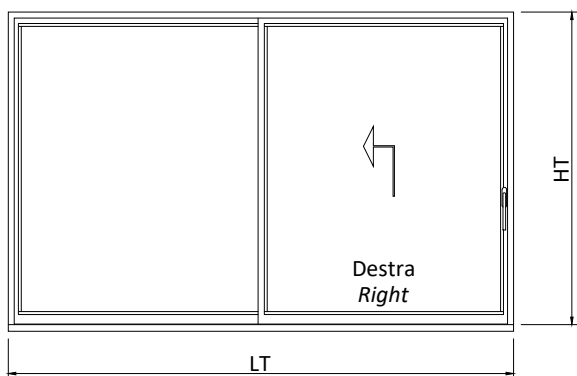

Schema | Type B 2 ante scorrevoli  
2 sliding sashes

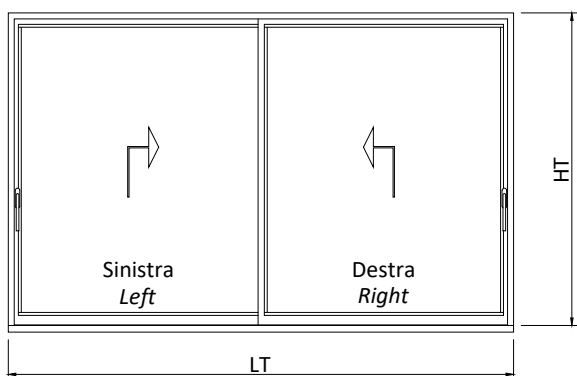

Limiti dimensionali | Dimensional limits (mm)

|                |    |              |         |
|----------------|----|--------------|---------|
| Telaio   Frame | LT | 1589 - 3789  | LT      |
|                | HT | 2407 - 3472  | HT      |
| Anta   Sash    | LA | 800 - 1900*  | LT/2+18 |
|                | HA | 2365 - 3430* | HT - 42 |

fino a | up to  
1000 kg\*\*

\* rif. dimensioni del campione sottoposto a test di tenuta aria, acqua, vento  
ref. dimensions of the door tested to air, water and wind resistant

\*\* vedi capitolo 2.3  
see chapter 2.3

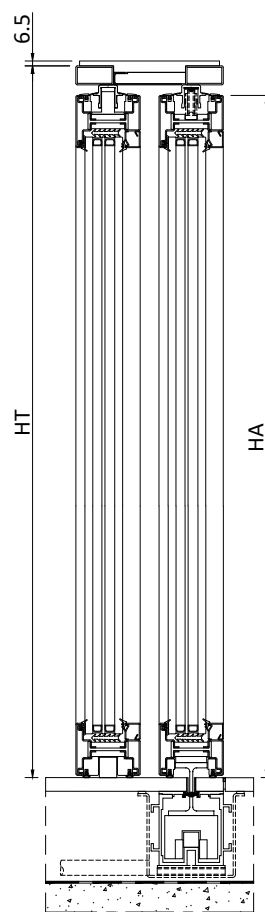

Schema | Type A

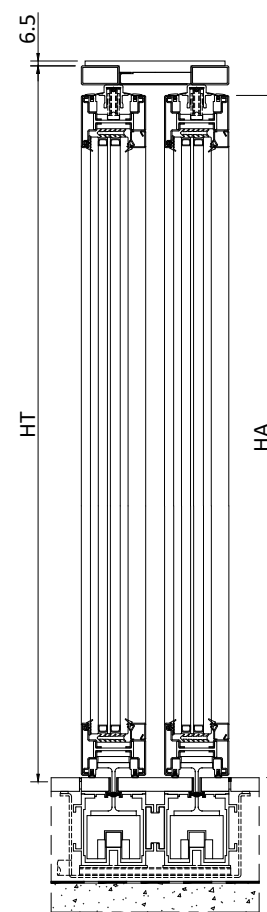

Schema | Type B

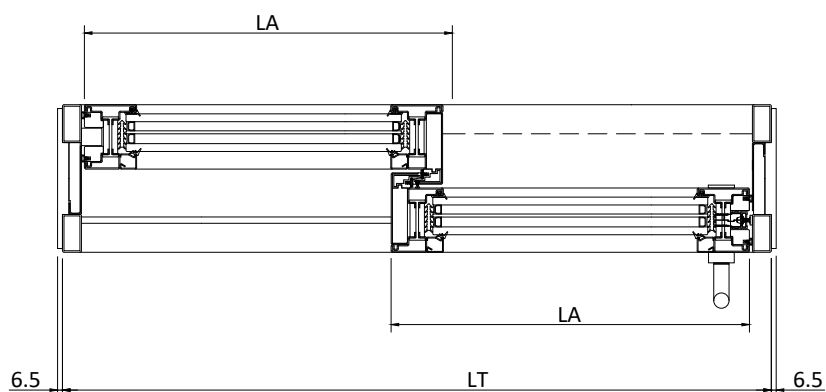

Schema | Type C Serie di ante fisse e ante scorrevoli  
Series of 1 sliding and 1 fixed sash

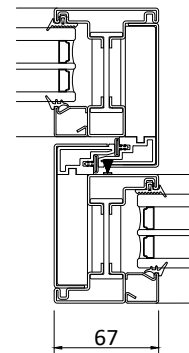
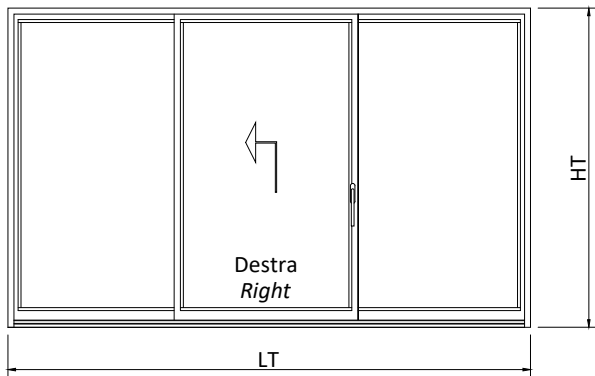

Limiti dimensionali | Dimensional limits (mm)

|                |    |  |           |
|----------------|----|--|-----------|
| Telaiο   Frame | LT | 2324 - 5624                                | LT        |
|                | HT | 2407 - 3472                                | HT        |
| Anta   Sash    | LA | 800 - 1900*<br>fino a   up to<br>1000 kg** | LT/3+25.5 |
|                | HA | 2365 - 3430*                               | HT - 42   |

\* rif. dimensioni del campione sottoposto a test di tenuta aria, acqua, vento  
ref. dimensions of the door tested to air, water and wind resistant

\*\* vedi capitolo 2.3  
see chapter 2.3

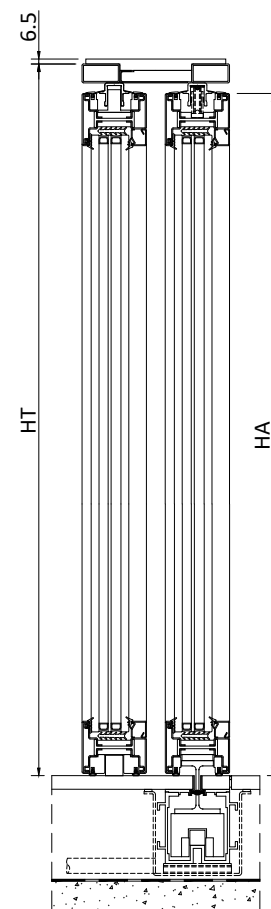
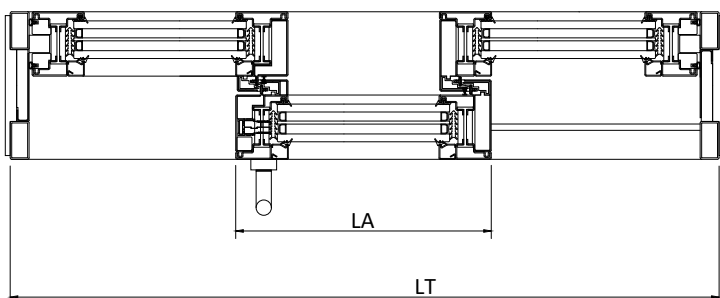

Schema | Type C

Schema | Type E 2 ante scorrevoli e 2 ante fisse  
2 sliding and 2 fixed sashes

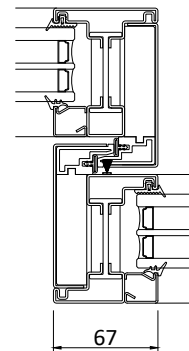
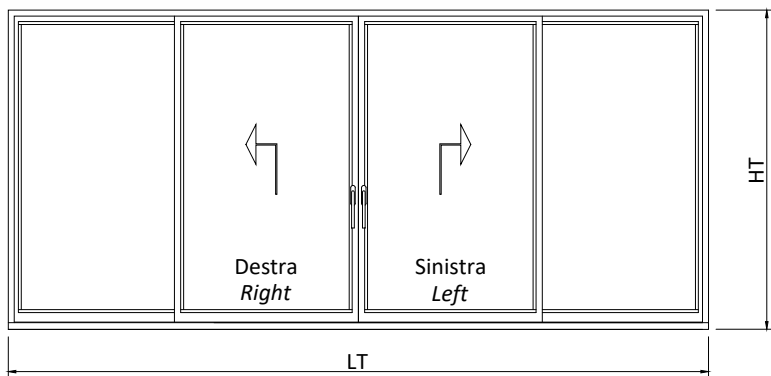

Schema | Type F 4 ante scorrevoli  
4 sliding sashes

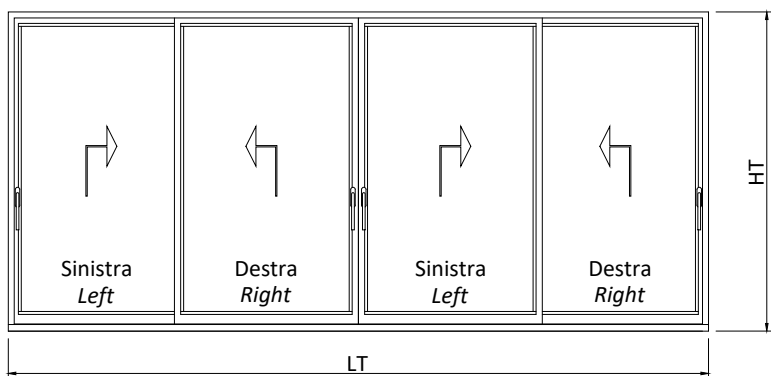

Limiti dimensionali | Dimensional limits (mm)

|                |    |              |         |
|----------------|----|--------------|---------|
| Telaio   Frame | LT | 3124 - 7524  | LT      |
|                | HT | 2407 - 3472  | HT      |
| Anta   Sash    | LA | 800 - 1900*  | LT/4+41 |
|                | HA | 2365 - 3430* | HT - 42 |

fino a | up to  
1000 kg\*\*

\* rif. dimensioni del campione sottoposto a test di tenuta aria, acqua, vento  
ref. dimensions of the door tested to air, water and wind resistant

\*\* vedi capitolo 2.3  
see chapter 2.3

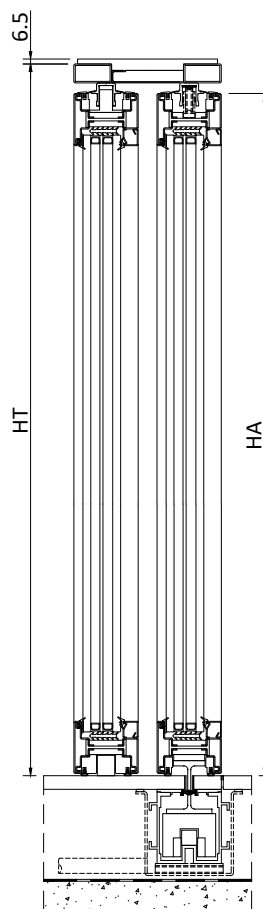

Schema | Type E

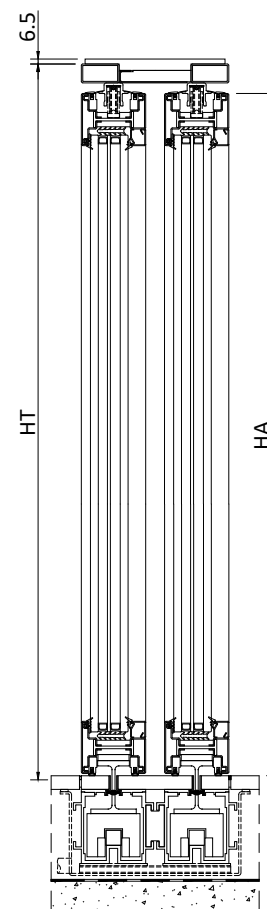

Schema | Type F

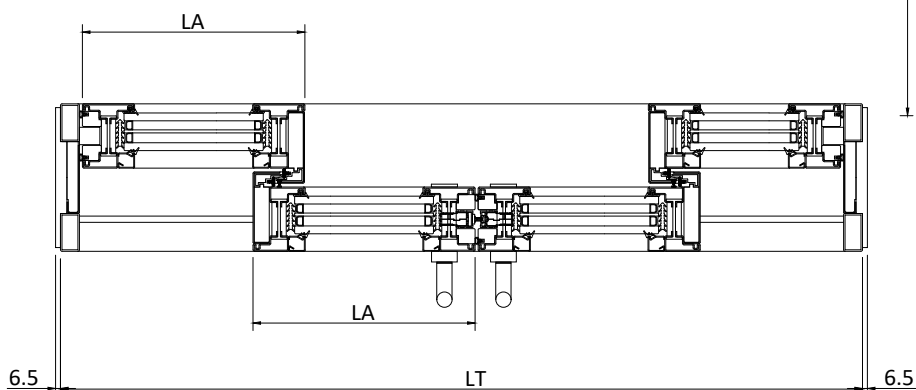

Schema | Type A3 2 ante scorrevoli ed 1 anta fissa  
2 sliding and 1 fixed sash

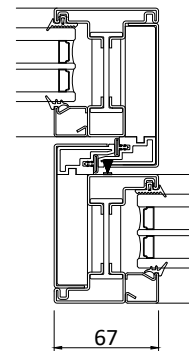
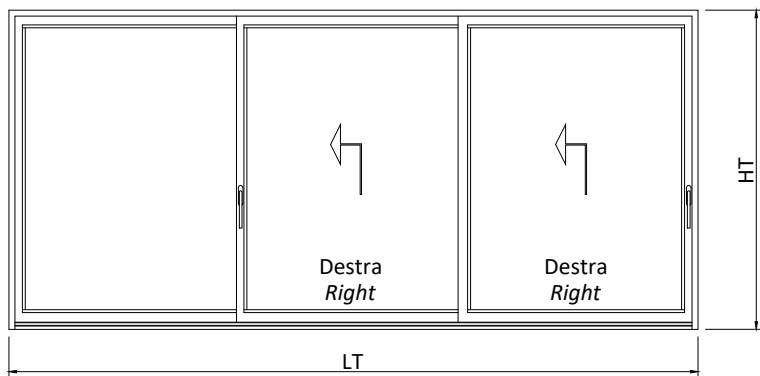

Schema | Type B3 3 ante scorrevoli  
3 sliding sash

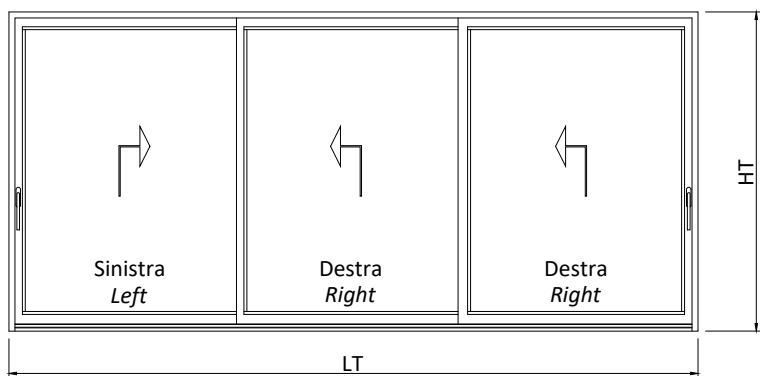

Limiti dimensionali | Dimensional limits (mm)

|                |    |              |         |
|----------------|----|--------------|---------|
| Telaio   Frame | LT | 2320 - 5620  | LT      |
|                | HT | 2407 - 3472  | HT      |
| Anta   Sash    | LA | 800 - 1900*  | LT/3+43 |
|                | HA | 2365 - 3430* | HT - 42 |

fino a | up to  
1000 kg\*\*

\* rif. dimensioni del campione sottoposto a test di tenuta aria, acqua, vento  
ref. dimensions of the door tested to air, water and wind resistant

\*\* vedi capitolo 2.3  
see chapter 2.3

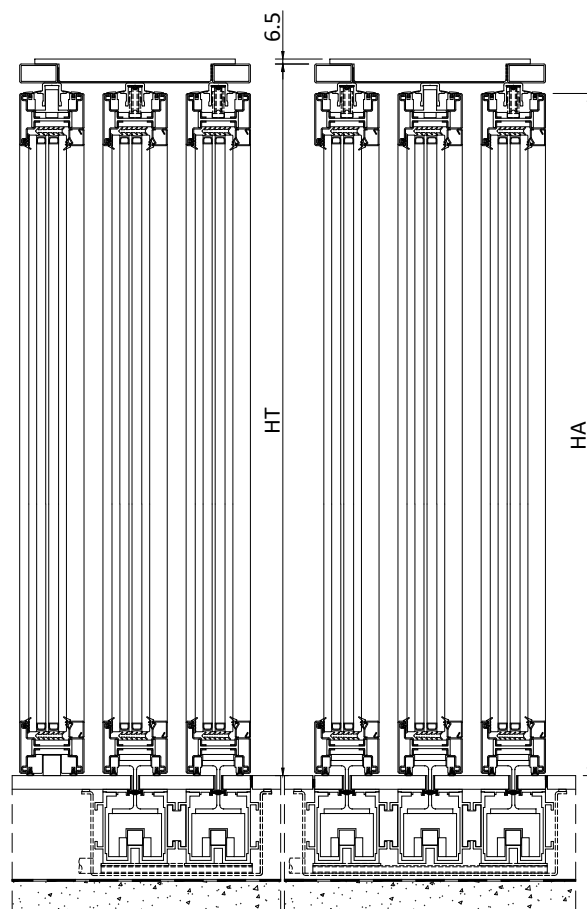

Schema | Type A3

Schema | Type B3

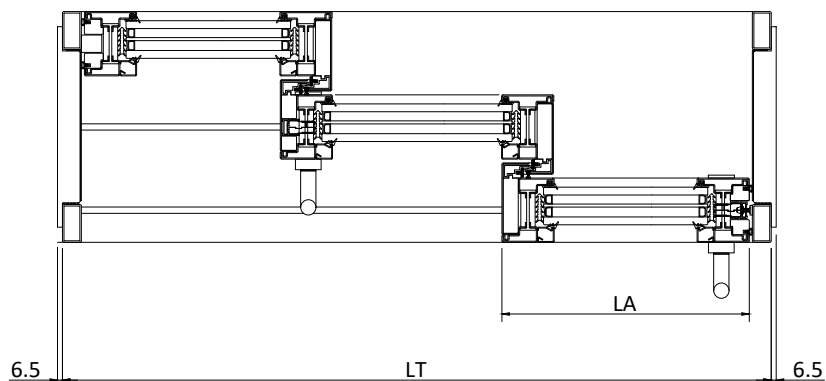

Schema | Type C3 2 ante scorrevoli ed 1 anta fissa  
2 sliding and 1 fixed sash

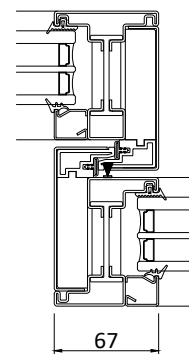
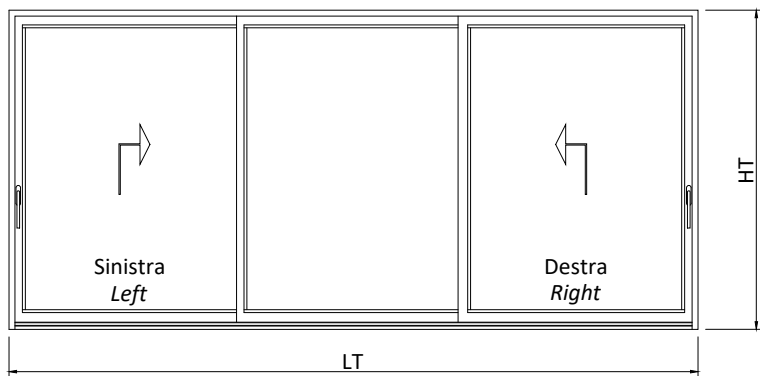

Limiti dimensionali | Dimensional limits (mm)

|                |    |              |         |
|----------------|----|--------------|---------|
| Telaiο   Frame | LT | 2320 - 5620  | LT      |
|                | HT | 2407 - 3472  | HT      |
| Anta   Sash    | LA | 800 - 1900*  | LT/3+43 |
|                | HA | 2365 - 3430* | HT - 42 |

fino a | up to  
1000 kg\*\*

\* rif. dimensioni del campione sottoposto a test di tenuta aria, acqua, vento  
ref. dimensions of the door tested to air, water and wind resistant

\*\* vedi capitolo 2.3  
see chapter 2.3

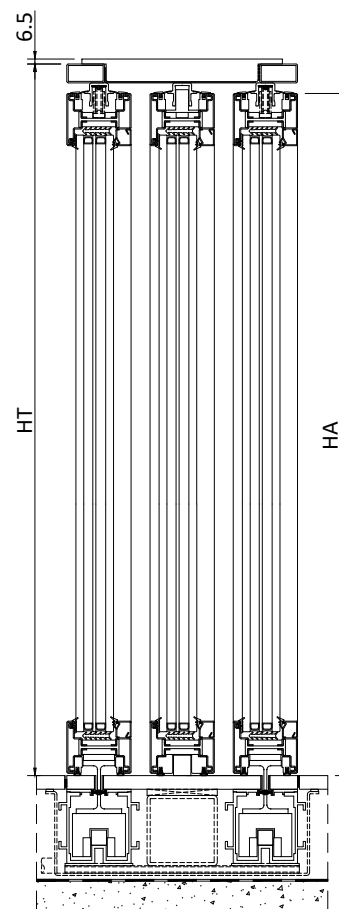

Schema | Type C3

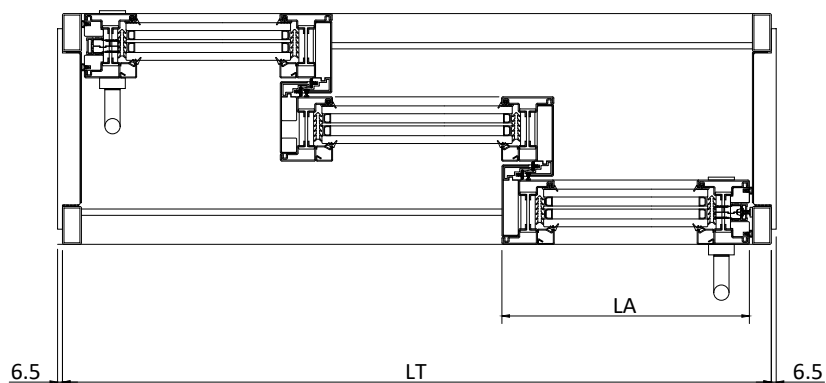

Schema | Type E3 3 ante scorrevoli e 2 ante fisse  
4 sliding and 2 fixed sashes

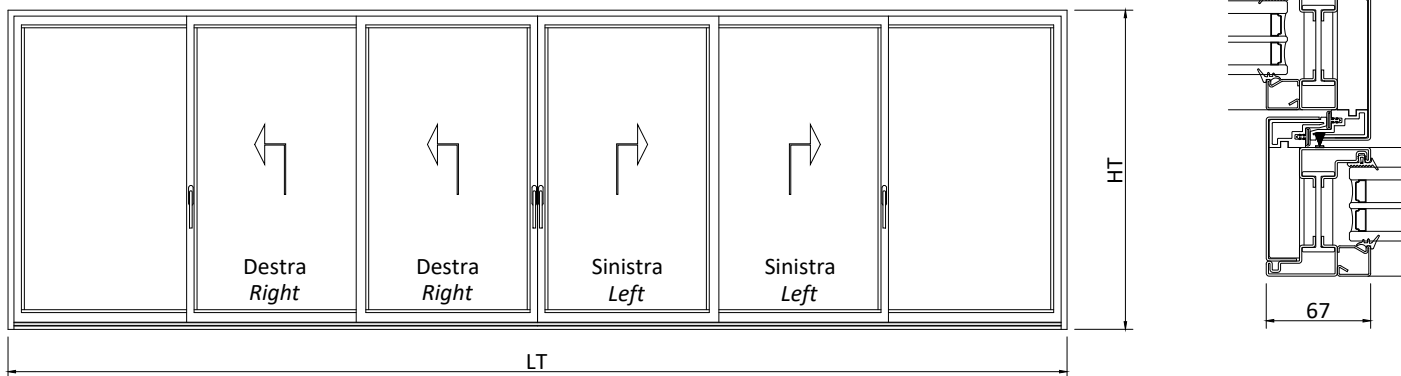

Schema | Type F3 6 ante scorrevoli  
6 sliding sashes

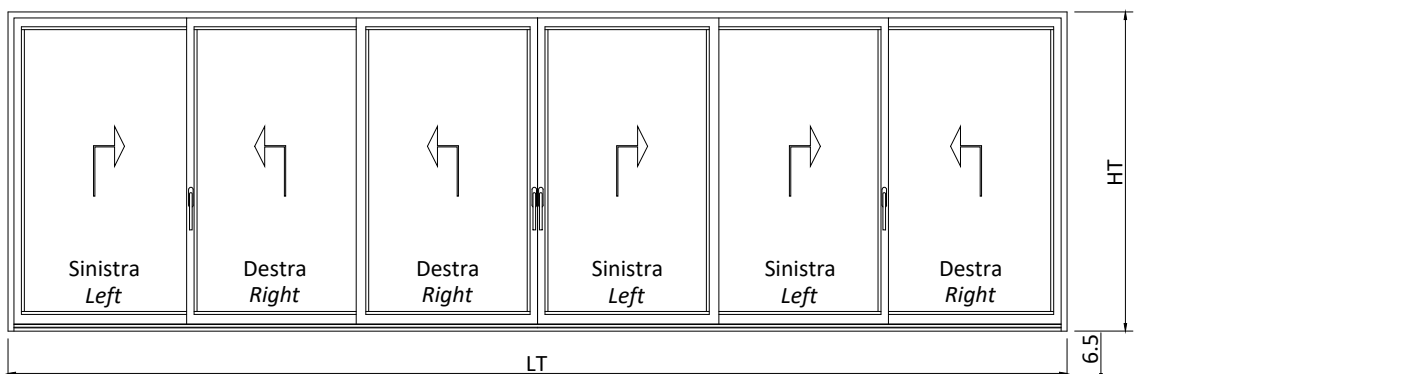

Limiti dimensionali | Dimensional limits (mm)

|                |    |              |         |
|----------------|----|--------------|---------|
| Telaio   Frame | LT | 4586 - 11186 | LT      |
|                | HT | 2407 - 3472  | HT      |
| Anta   Sash    | LA | 800 - 1900*  | LT/6+52 |
|                | HA | 2365 - 3430* | HT - 42 |

fino a | up to  
1000 kg\*\*

\* rif. dimensioni del campione sottoposto a test di tenuta aria, acqua, vento  
ref. dimensions of the door tested to air, water and wind resistant

\*\* vedi capitolo 2.3  
see chapter 2.3

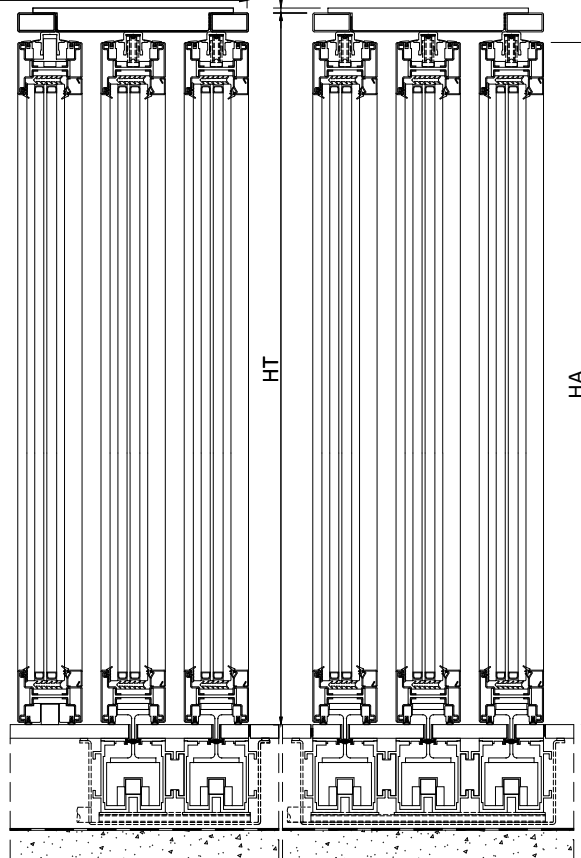

Schema | Type E

Schema | Type F

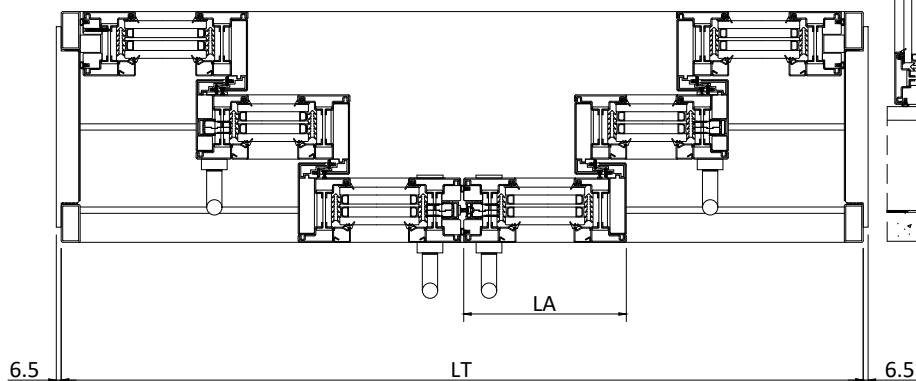



Schema | Type S1 1 anta scorrevole a scomparsa  
1 sliding sash into the wall

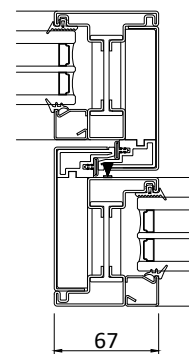
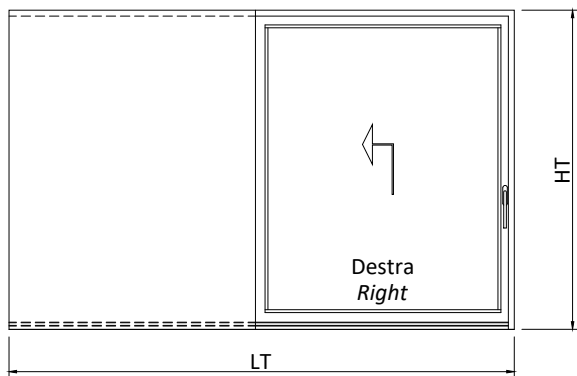

Limiti dimensionali | Dimensional limits (mm)

|                |    |              |                             |
|----------------|----|--------------|-----------------------------|
| Telaiο   Frame | LT | 1589 - 3789  | LT                          |
|                | HT | 2407 - 3472  | HT                          |
| Anta   Sash    | LA | 800 - 1900*  | fino a   up to<br>1000 kg** |
|                | HA | 2365 - 3430* |                             |

\* rif. dimensioni del campione sottoposto a test di tenuta aria, acqua, vento  
ref. dimensions of the door tested to air, water and wind resistant

\*\* vedi capitolo 2.3  
see chapter 2.3

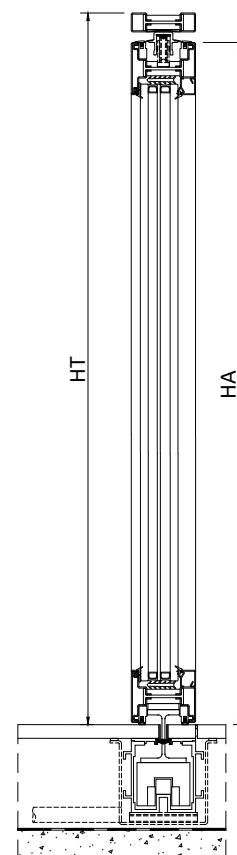
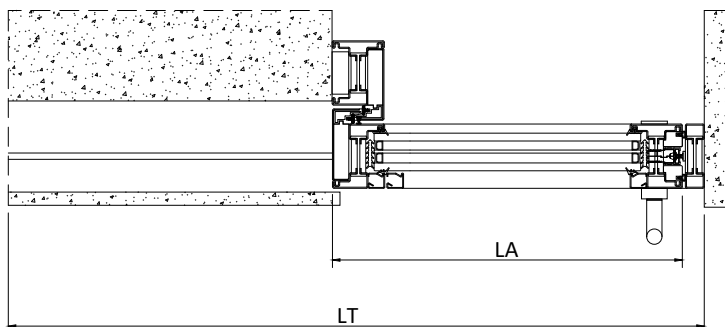

Schema | Type S

Schema | Type S2 2 ante scorrevoli a scomparsa  
2 sliding sashes into the wall

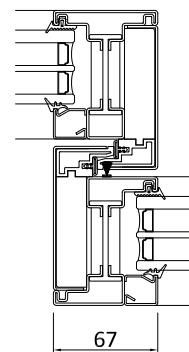
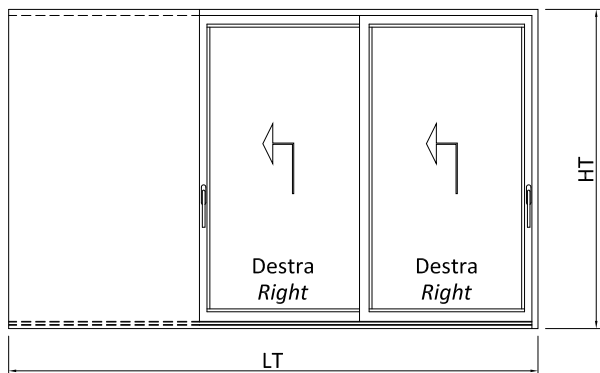

Limiti dimensionali | Dimensional limits (mm)

|                |    |              |                             |
|----------------|----|--------------|-----------------------------|
| Telaio   Frame | LT | 2320 - 5620  | LT                          |
|                | HT | 2407 - 3472  | HT                          |
| Anta   Sash    | LA | 800 - 1900*  | fino a   up to<br>1000 kg** |
|                | HA | 2365 - 3430* |                             |

\* rif. dimensioni del campione sottoposto a test di tenuta aria, acqua, vento  
ref. dimensions of the door tested to air, water and wind resistant

\*\* vedi capitolo 2.3  
see chapter 2.3

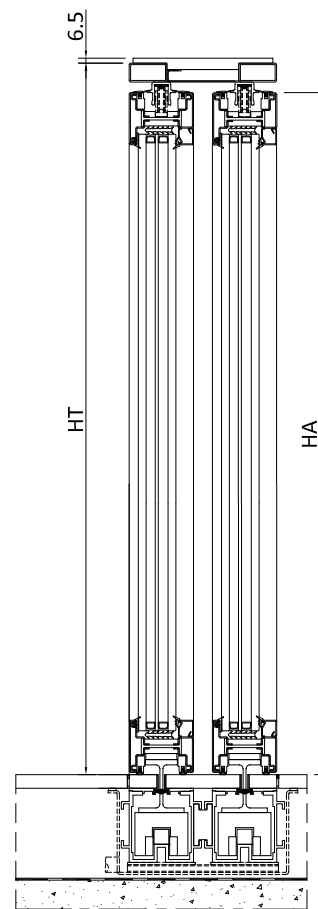
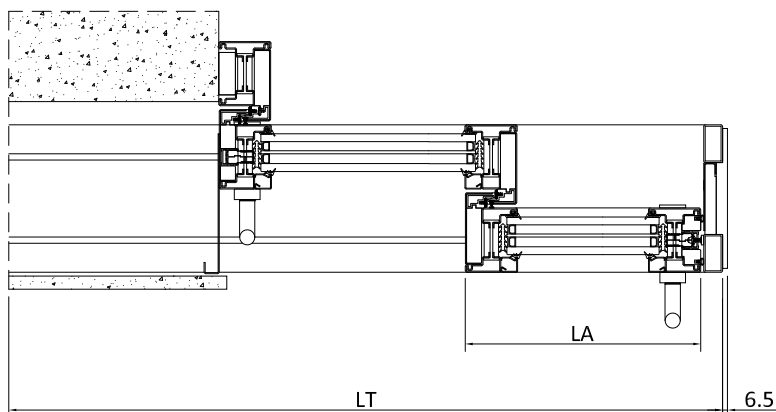

Schema | Type S2

Schema | Type S3 3 ante scorrevoli a scomparsa  
3 sliding sashes into the wall

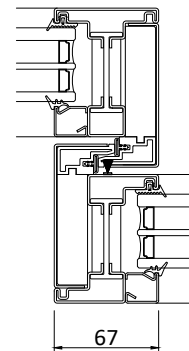
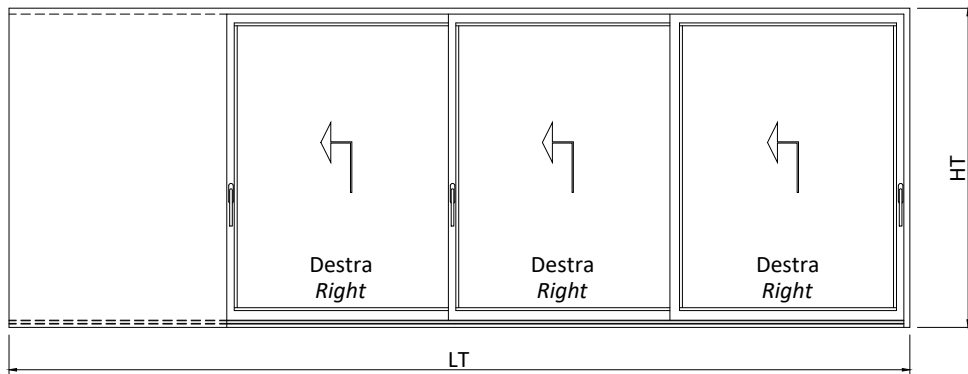

Limiti dimensionali | Dimensional limits (mm)

|                |    |              |                             |
|----------------|----|--------------|-----------------------------|
| Telaiο   Frame | LT | 3051 - 7451  | LT                          |
|                | HT | 2407 - 3472  | HT                          |
| Anta   Sash    | LA | 800 - 1900*  | fino a   up to<br>1000 kg** |
|                | HA | 2365 - 3430* |                             |

\* rif. dimensioni del campione sottoposto a test di tenuta aria, acqua, vento  
ref. dimensions of the door tested to air, water and wind resistant

\*\* vedi capitolo 2.3  
see chapter 2.3

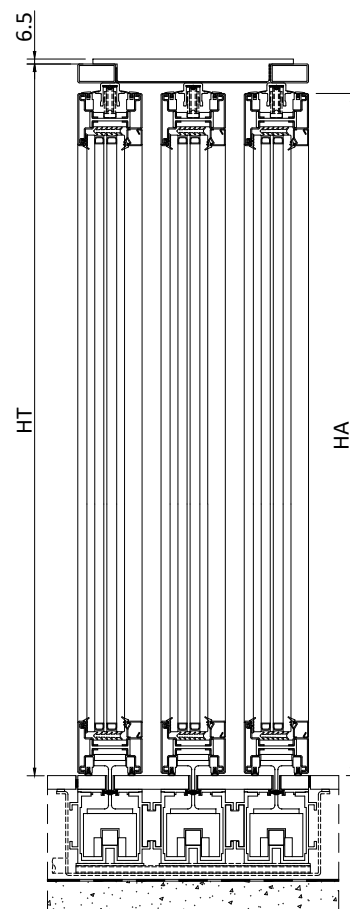
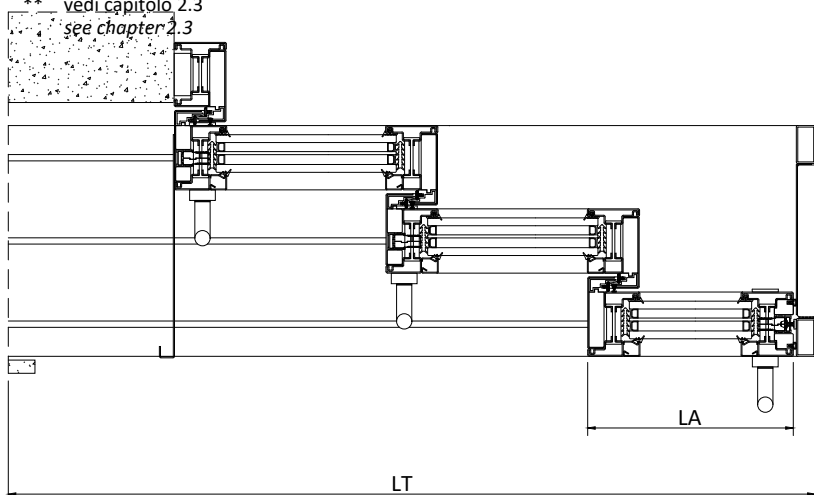

Schema | Type SC2

Schema | Type T1 2 ante scorrevoli coassiali a scomparsa  
2 coaxial sliding sashes into the wall

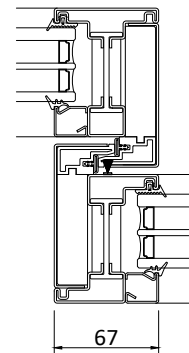
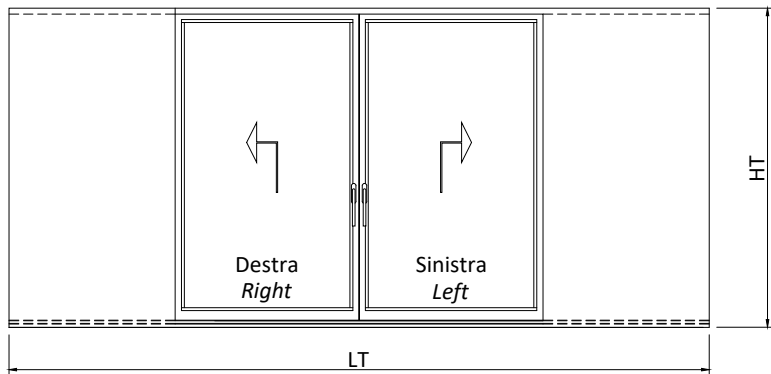

Limiti dimensionali | Dimensional limits (mm)

|                |    |              |                             |
|----------------|----|--------------|-----------------------------|
| Frame   Telaio | LT | 3124 - 7524  | LT                          |
|                | HT | 2407 - 3472  | HT                          |
| Sash   Anta    | LA | 800 - 1900*  | fino a   up to<br>1000 kg** |
|                | HA | 2365 - 3430* |                             |

\* rif. dimensioni del campione sottoposto a test di tenuta aria, acqua, vento  
ref. dimensions of the door tested to air, water and wind resistant

\*\* vedi capitolo 2.3  
see chapter 2.3

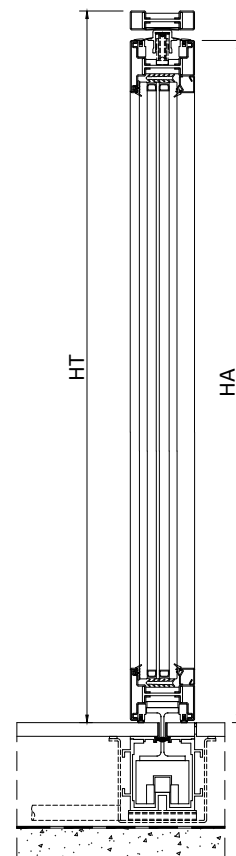
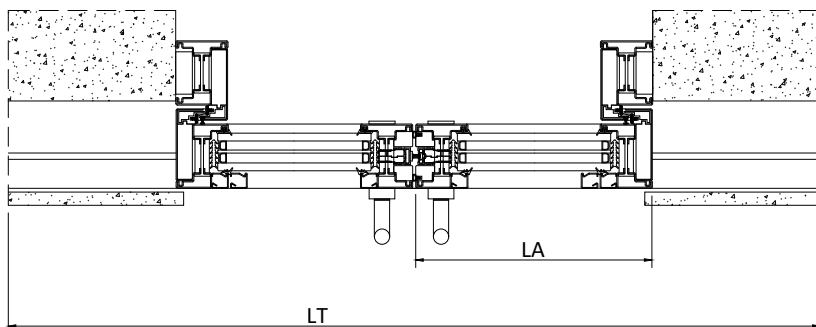

Schema | Type SC

Schema | Type T2 4 ante scorrevoli coassiali a scomparsa  
4 coaxial sliding sashes into the wall

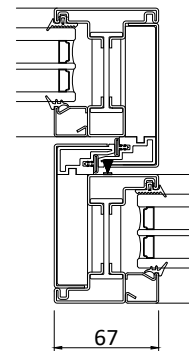
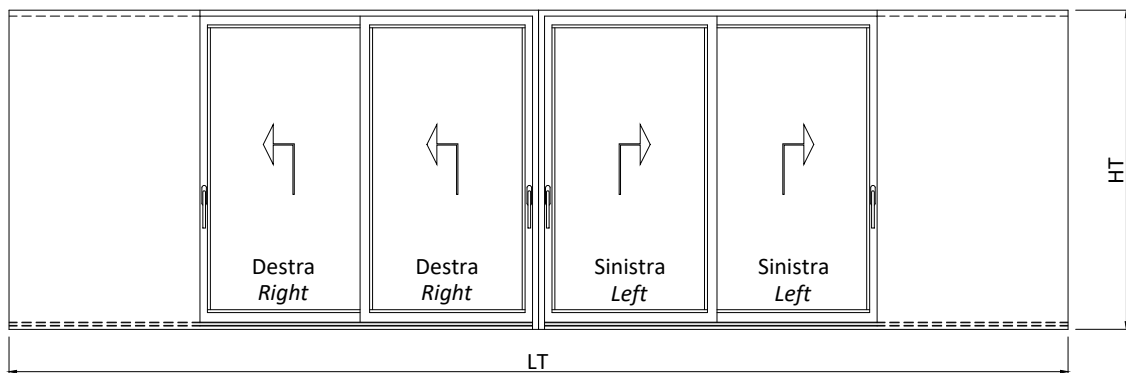

Limiti dimensionali | Dimensional limits (mm)

|                |    |              |                             |
|----------------|----|--------------|-----------------------------|
| Telaiο   Frame | LT | 4586 - 11186 | LT                          |
|                | HT | 2407 - 3472  | HT                          |
| Anta   Sash    | LA | 800 - 1900*  | fino a   up to<br>1000 kg** |
|                | HA | 2365 - 3430* |                             |

\* rif. dimensioni del campione sottoposto a test di tenuta aria, acqua, vento  
ref. dimensions of the door tested to air, water and wind resistant

\*\* vedi capitolo 2.3  
see chapter 2.3

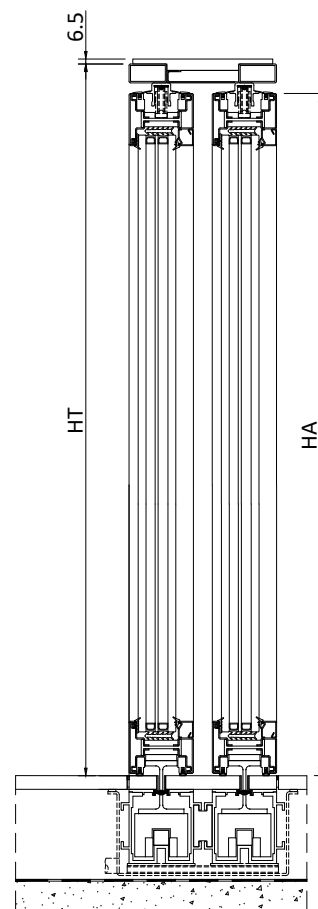
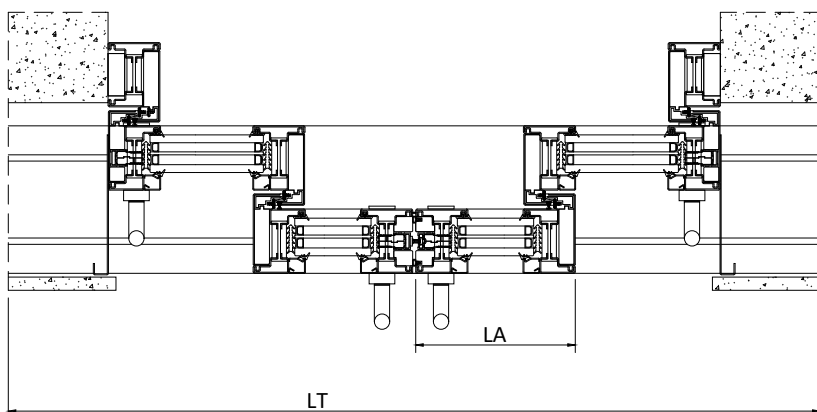

Schema | Type SC2

Schema | Type T3 6 ante scorrevoli coassiali a scomparsa  
6 coaxial sliding sashes into the wall

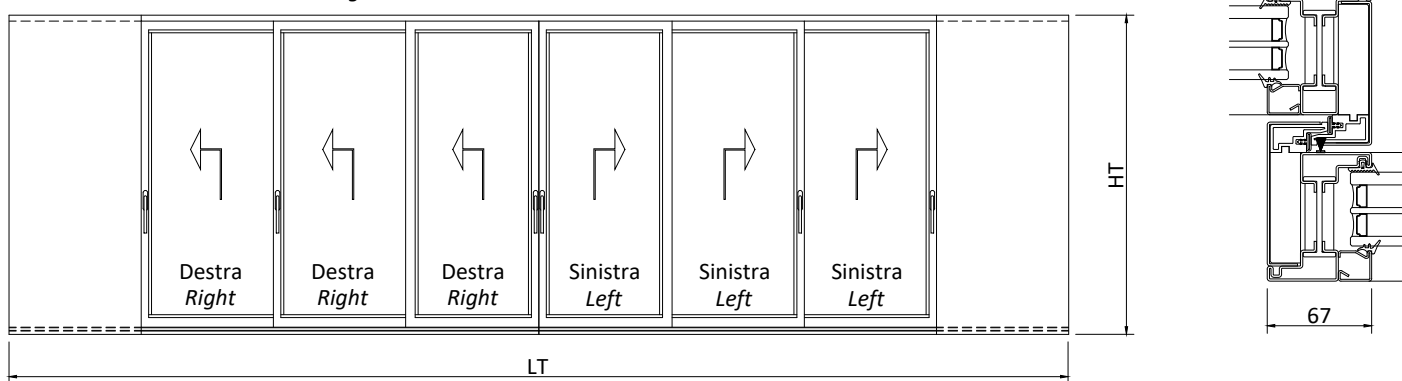

Limiti dimensionali | Dimensional limits (mm)

|                |    |              |                             |
|----------------|----|--------------|-----------------------------|
| Telaio   Frame | LT | 6048 - 14848 | LT                          |
|                | HT | 2407 - 3472  | HT                          |
| Anta   Sash    | LA | 800 - 1900*  | fino a   up to<br>1000 kg** |
|                | HA | 2365 - 3430* |                             |

\* rif. dimensioni del campione sottoposto a test di tenuta aria, acqua, vento  
ref. dimensions of the door tested to air, water and wind resistant

\*\* vedi capitolo 2.3  
see chapter 2.3

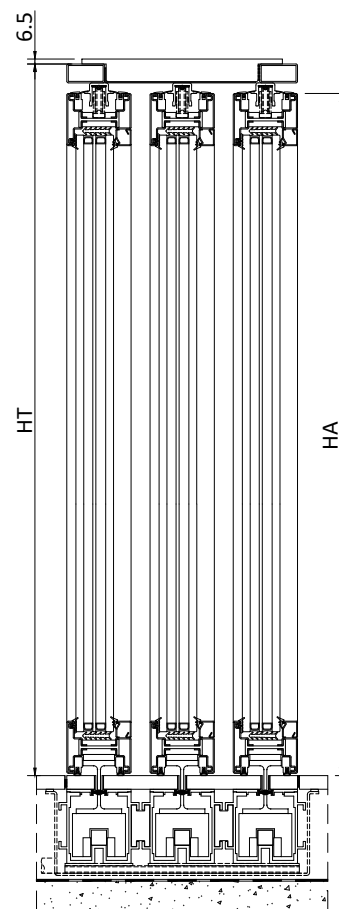
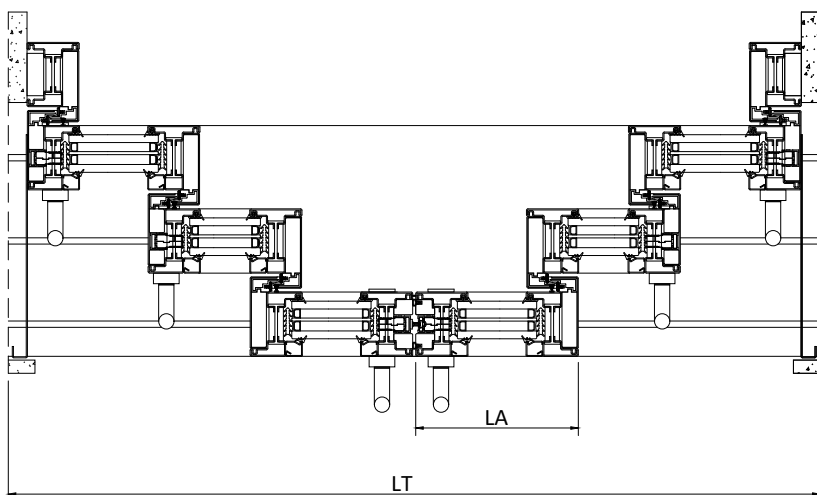

Schema | Type SC

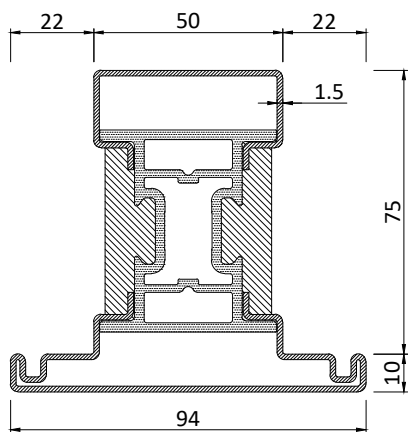

PR1102

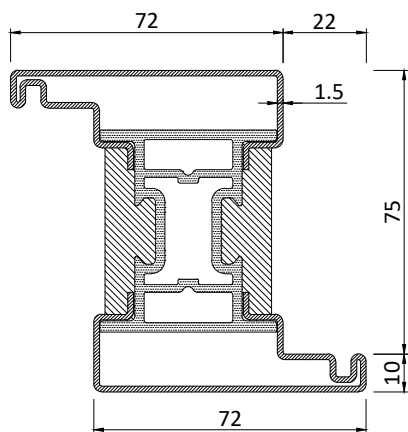

PR1103

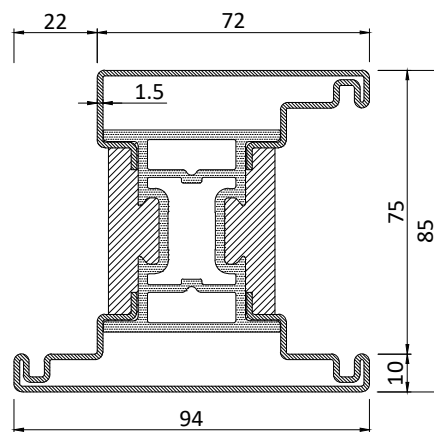

PR1105

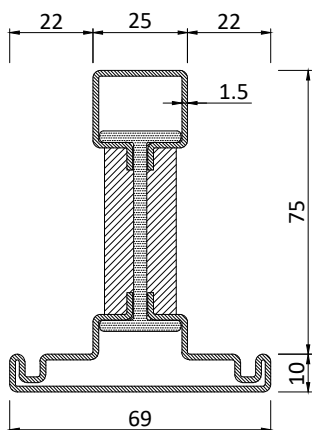

PR1302

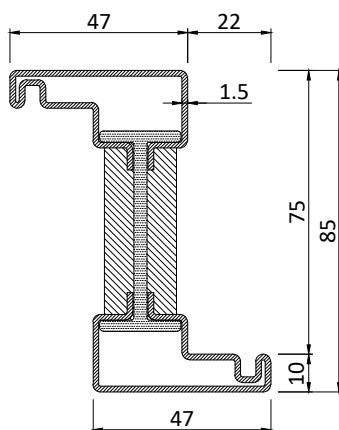

PR1303

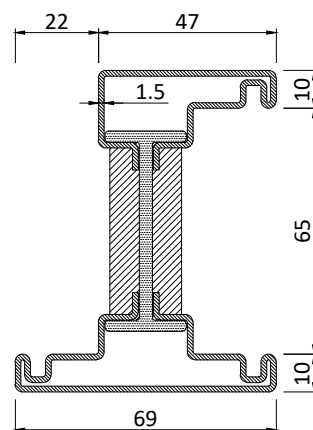

PR1305

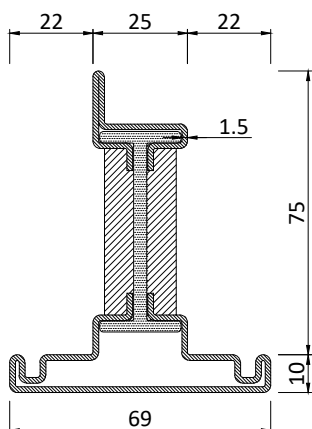

PR1362

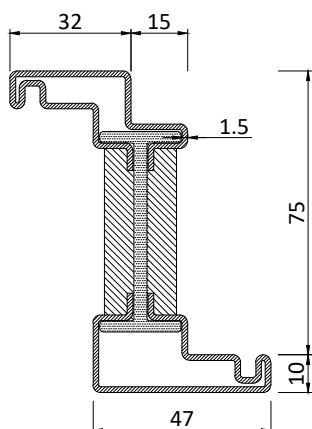

PR1313

Materiali e finiture disponibili indicate a pag. 2.1.7 se non specificate nella presente pagina  
Materials and finishing available are indicated at page 2.1.7 if not indicated in this page

| Profilo / Profile<br>n° | P<br>Kg/m   |      | A<br>m <sup>2</sup> /m | Jx<br>cm <sup>4</sup> | Jy<br>cm <sup>4</sup> | L<br>m | Profilo / Profile<br>n° | P<br>Kg/m   |      | A<br>m <sup>2</sup> /m | Jx<br>cm <sup>4</sup> | Jy<br>cm <sup>4</sup> | L<br>m |
|-------------------------|-------------|------|------------------------|-----------------------|-----------------------|--------|-------------------------|-------------|------|------------------------|-----------------------|-----------------------|--------|
|                         | ZN / I - CT | OT   |                        |                       |                       |        |                         | ZN / I - CT | OT   |                        |                       |                       |        |
| PR1102                  | 5,48        | 5,78 | 0,40                   | 38,44                 | 37,76                 | 3-6    | PR1305                  | 4,80        | 5,11 | 0,40                   | 39,27                 | 18,76                 | 6      |
| PR1103                  | 5,51        | 5,83 | 0,40                   | 41,74                 | 34,49                 | 3-6    | PR1362                  | 4,20        | 4,46 | 0,33                   | 26,20                 | 13,05                 | 3-6    |
| PR1105                  | 6,05        | 6,41 | 0,46                   | 45,99                 | 47,37                 | 6      | PR1313                  | 4,48        | 4,78 | 0,33                   | 33,50                 | 12,121                | 3-6    |
| PR1302                  | 4,22        | 4,48 | 0,35                   | 30,61                 | 14,14                 | 3-6    |                         |             |      |                        |                       |                       |        |
| PR1303                  | 4,25        | 4,51 | 0,35                   | 35,07                 | 12,71                 | 3-6    |                         |             |      |                        |                       |                       |        |

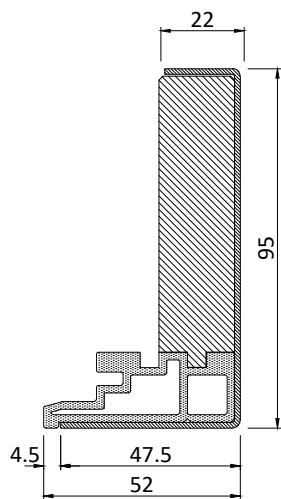

PR1142

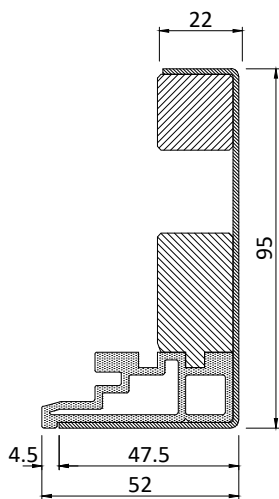

PR1145

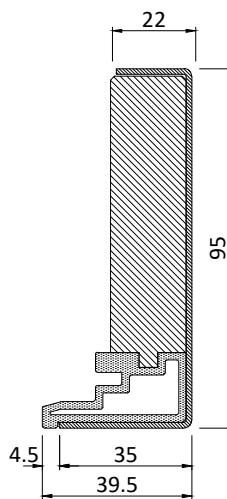

PR1342

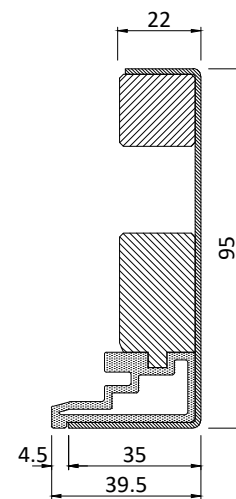

PR1345

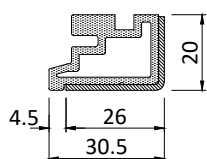

PR1343

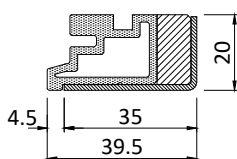

PR1346

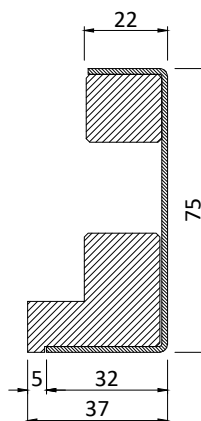

PR1347

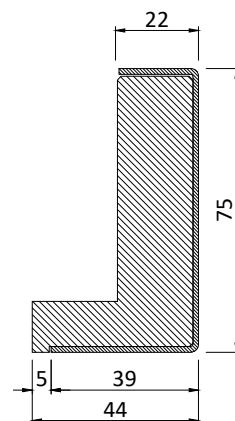

PR1349

Materiali e finiture disponibili indicate a pag. 2.1.7 se non specificate nella presente pagina  
Materials and finishing available are indicated at page 2.1.7 if not indicated in this page

| Profilo / Profile<br>n° | P<br>Kg/m |      | A<br>m <sup>2</sup> /m | Jx<br>cm <sup>4</sup> | Jy<br>cm <sup>4</sup> | L<br>m | Profilo / Profile<br>n° | P<br>Kg/m |      | A<br>m <sup>2</sup> /m | Jx<br>cm <sup>4</sup> | Jy<br>cm <sup>4</sup> | L<br>m |
|-------------------------|-----------|------|------------------------|-----------------------|-----------------------|--------|-------------------------|-----------|------|------------------------|-----------------------|-----------------------|--------|
|                         | ZN / 1-CT | OT   |                        |                       |                       |        |                         | ZN / 1-CT | OT   |                        |                       |                       |        |
| PR1142                  | 3,90      | 4,05 | 0,16                   |                       |                       | 3-4    | PR1346                  | 1,05      | 1,10 | 0,06                   |                       |                       | 3-4    |
| PR1145                  | 3,80      | 4,00 | 0,16                   |                       |                       | 3-4    | PR1347                  | 2,70      | 2,80 | 0,13                   |                       |                       | 3-4    |
| PR1342                  | 3,55      | 3,70 | 0,15                   |                       |                       | 3-4    | PR1349                  | 3,30      | 3,40 | 0,14                   |                       |                       | 3-4    |
| PR1345                  | 3,10      | 3,15 | 0,15                   |                       |                       | 3-4    |                         |           |      |                        |                       |                       |        |
| PR1343                  | 0,76      | 0,80 | 0,05                   |                       |                       | 3-4    |                         |           |      |                        |                       |                       |        |



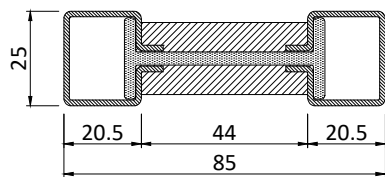

PR1320

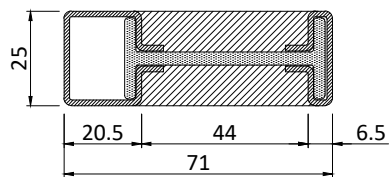

PR1320M

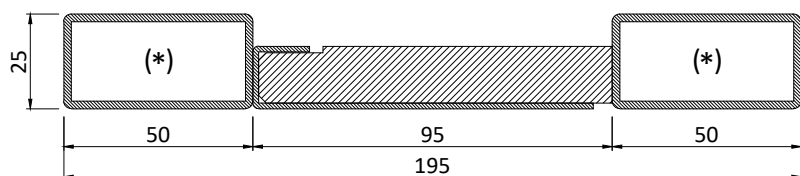

PR2986

ZN L Profilo/Profile 3 - 4 - 6 m  
I - CT - OT L Profilo/Profile 3 - 4 m

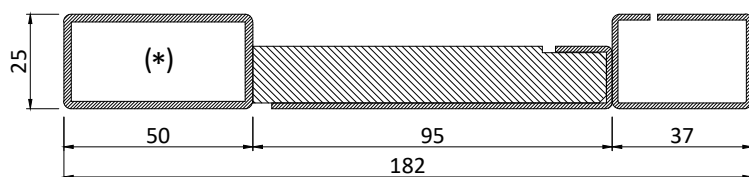

PR2987.2

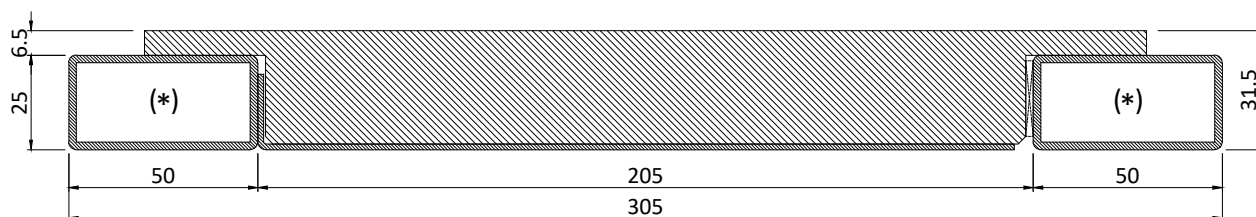

PR2986L.3

ZN L Profilo/Profile 3 - 4 - 6 m  
I - CT - OT L Profilo/Profile 3 - 4 m

(\*) Vedi pag. 2.1.4

Materiali e finiture disponibili indicate a pag. 2.1.7 se non specificate nella presente pagina  
Materials and finishing available are indicated at page 2.1.7 if not indicated in this page

| Profilo / Profile<br>n° | P<br>Kg/m   |       | A<br>m <sup>2</sup> /m | Jx<br>cm <sup>4</sup> | Jy<br>cm <sup>4</sup> | L<br>m | Profilo / Profile<br>n° | P<br>Kg/m   |    | A<br>m <sup>2</sup> /m | Jx<br>cm <sup>4</sup> | Jy<br>cm <sup>4</sup> | L<br>m |
|-------------------------|-------------|-------|------------------------|-----------------------|-----------------------|--------|-------------------------|-------------|----|------------------------|-----------------------|-----------------------|--------|
|                         | ZN / I - CT | OT    |                        |                       |                       |        |                         | ZN / I - CT | OT |                        |                       |                       |        |
| PR1320                  | 2,80        | 3,00  | 0,22                   |                       |                       | 6      |                         |             |    |                        |                       |                       |        |
| PR1320M                 | 2,85        | 3,05  | 0,19                   |                       |                       | 3      |                         |             |    |                        |                       |                       |        |
| PR2986                  | 7,30        | 7,65  | 0,43                   |                       |                       | 3-4-6  |                         |             |    |                        |                       |                       |        |
| PR2987.2                | 7,25        | 7,60  | 0,40                   |                       |                       | 3-4    |                         |             |    |                        |                       |                       |        |
| PR2986L.3               | 13,40       | 12,60 | 0,52                   |                       |                       | 3-4-6  |                         |             |    |                        |                       |                       |        |

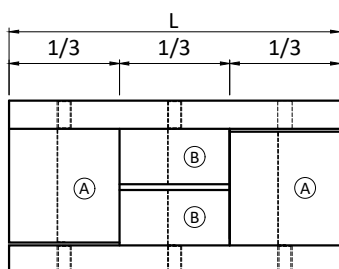
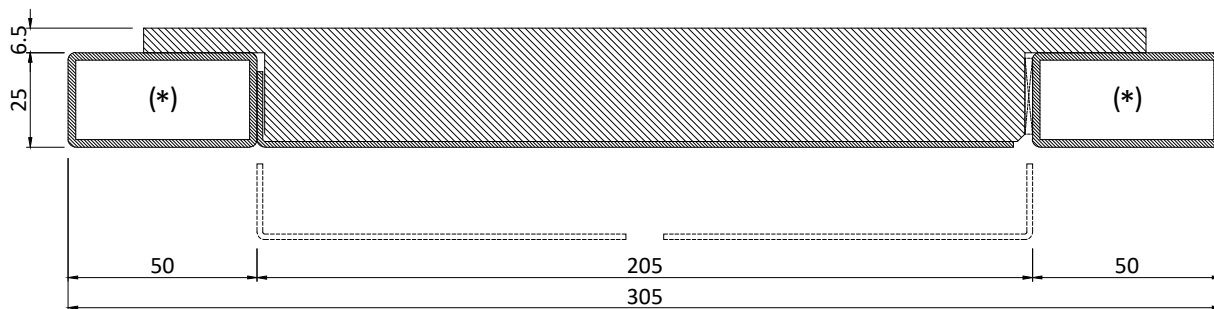

PR2986.3

ZN L Profilo/Profile 3 - 4 - 6 m  
I - CT - OT L Profilo/Profile 3 - 4 m

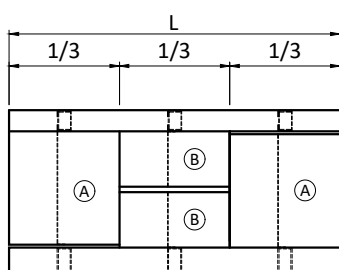
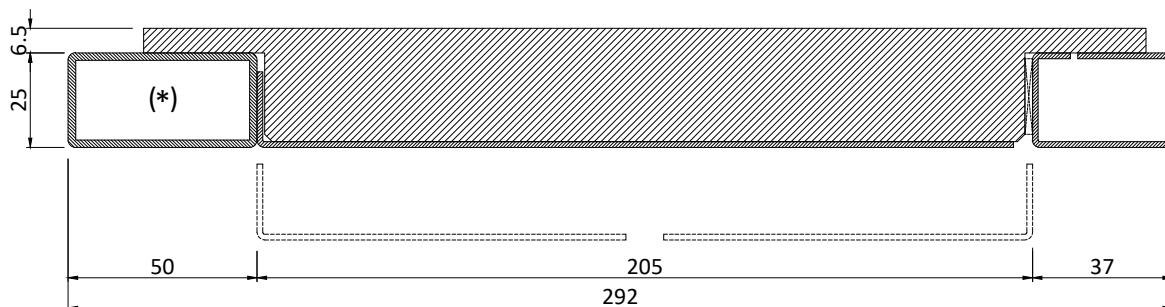

PR2987.3

ZN L Profilo/Profile 3 - 4 m  
I - CT - OT L Profilo/Profile 3 - 4 m

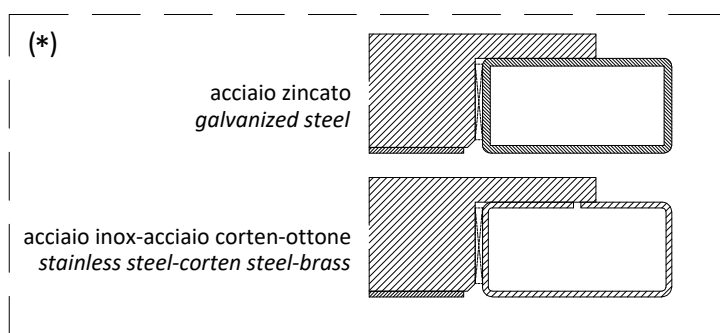

Materiali e finiture disponibili indicate a pag. 2.1.7 se non specificate nella presente pagina  
Materials and finishing available are indicated at page 2.1.7 if not indicated in this page

| Profilo / Profile<br>n° | P<br>Kg/m   |       | A<br>m <sup>2</sup> /m | Jx<br>cm <sup>4</sup> | Jy<br>cm <sup>4</sup> | L<br>m | Profilo / Profile<br>n° | P<br>Kg/m   |    | A<br>m <sup>2</sup> /m | Jx<br>cm <sup>4</sup> | Jy<br>cm <sup>4</sup> | L<br>m |
|-------------------------|-------------|-------|------------------------|-----------------------|-----------------------|--------|-------------------------|-------------|----|------------------------|-----------------------|-----------------------|--------|
|                         | ZN / I - CT | OT    |                        |                       |                       |        |                         | ZN / I - CT | OT |                        |                       |                       |        |
| PR2986.3                | 13,40       | 12,60 | 0,52                   |                       |                       | 3-4-6  |                         |             |    |                        |                       |                       |        |
| PR2987.3                | 13,00       | 12,20 | 0,52                   |                       |                       | 3-4    |                         |             |    |                        |                       |                       |        |
|                         |             |       |                        |                       |                       |        |                         |             |    |                        |                       |                       |        |
|                         |             |       |                        |                       |                       |        |                         |             |    |                        |                       |                       |        |

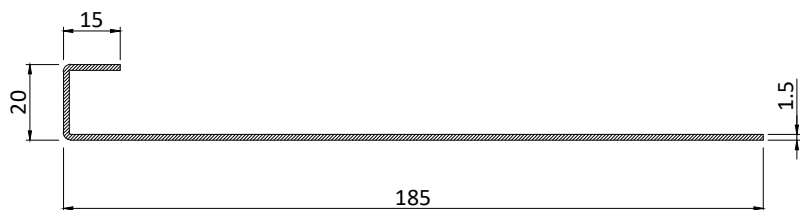

PR1160

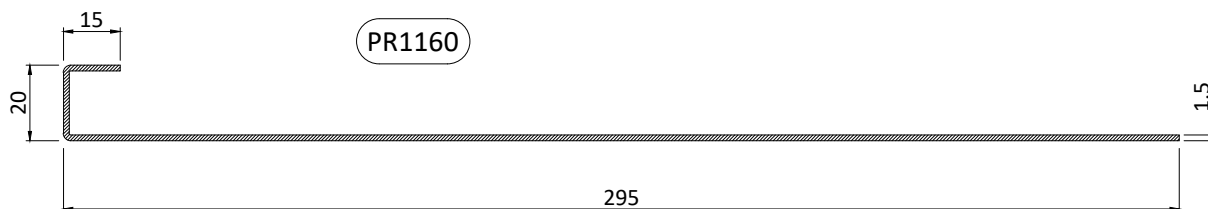

PR1180

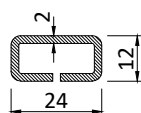
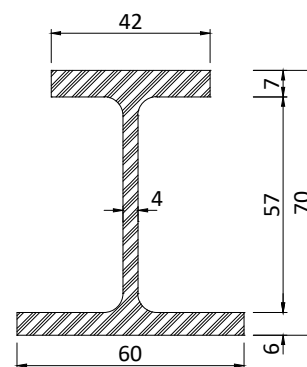

PR1145R

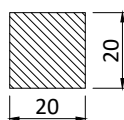

PRM195.LN standard

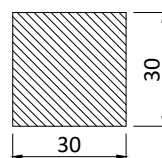

PRM195M.LN maggiorato increased

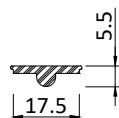

PAM145.NE

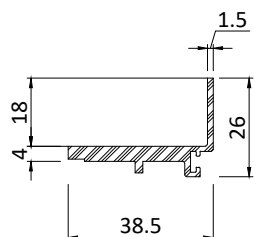

PAM191

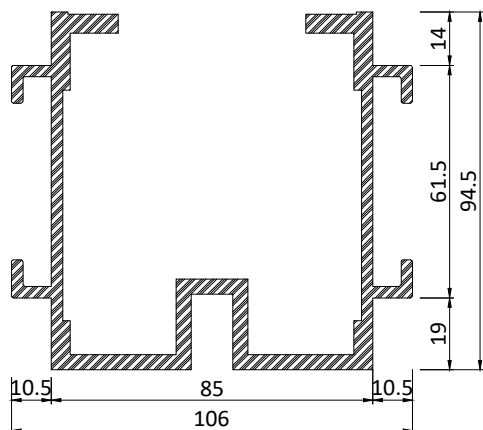

PAM195 standard

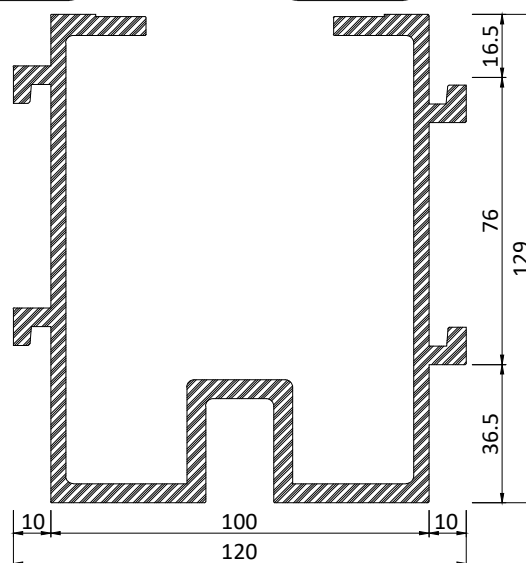

PAM195M maggiorato increased

Materiali e finiture disponibili indicate a pag. 2.1.7 se non specificate nella presente pagina  
Materials and finishing available are indicated at page 2.1.7 if not indicated in this page

| Profilo / Profile<br>n° | P<br>Kg/m   |      | A<br>m <sup>2</sup> /m | Jx<br>cm <sup>4</sup> | Jy<br>cm <sup>4</sup> | L<br>m | Profilo / Profile<br>n° | P<br>Kg/m      |    | A<br>m <sup>2</sup> /m | Jx<br>cm <sup>4</sup> | Jy<br>cm <sup>4</sup> | L<br>m  |
|-------------------------|-------------|------|------------------------|-----------------------|-----------------------|--------|-------------------------|----------------|----|------------------------|-----------------------|-----------------------|---------|
|                         | ZN / I - CT | OT   |                        |                       |                       |        |                         | ZN / I - CT    | OT |                        |                       |                       |         |
| PR1160                  | 2,60        | 2,80 | 0,22                   |                       |                       | 3-4    | PAM088                  | 2,35 alluminio |    |                        |                       |                       | 2-3-4-6 |
| PR1180                  | 3,90        | 4,20 | 0,32                   |                       |                       | 3-4    | PAM145.NE               | 0,13 alluminio |    |                        |                       |                       | 6       |
| PR1145R                 | 1,30        |      |                        |                       |                       | 3      | PAM191                  | 0,47 alluminio |    |                        |                       |                       | 6       |
| PRM195.LN               | 3,14        |      |                        |                       |                       | 2-4    | PAM195                  | 3,90 alluminio |    |                        |                       |                       | 6       |
| PRM195M.LN              | 7,10        |      |                        |                       |                       | 2-4    | PAM195M                 | 4,65 alluminio |    |                        |                       |                       | 6       |

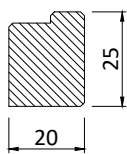

GU1305C

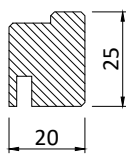

GU1305L

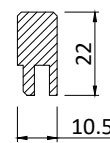

GU1305T

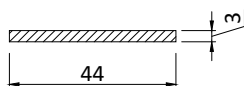

GU1311

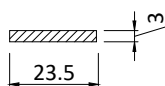

GU1311R

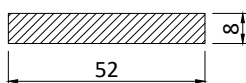

GUM020

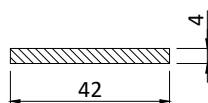

GUM088

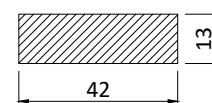

GUM088M

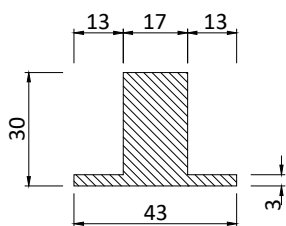

GUM104

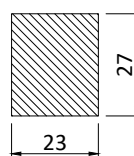

GUM105

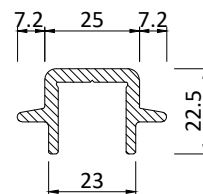

GUM145

Materiali e finiture disponibili indicate a pag. 2.1.7 se non specificate nella presente pagina  
Materials and finishing available are indicated at page 2.1.7 if not indicated in this page

| Profilo / Profile n° | P Kg/m         | A m <sup>2</sup> /m | Jx cm <sup>4</sup> | Jy cm <sup>4</sup> | L m | Profilo / Profile n° | P Kg/m         | A m <sup>2</sup> /m | Jx cm <sup>4</sup> | Jy cm <sup>4</sup> | L m |
|----------------------|----------------|---------------------|--------------------|--------------------|-----|----------------------|----------------|---------------------|--------------------|--------------------|-----|
|                      | ZN / I - CT OT |                     |                    |                    |     |                      | ZN / I - CT OT |                     |                    |                    |     |
| GU1305C              | 0,65 pvc       |                     |                    |                    | 3   | GUM088               | 0,28 pvc       |                     |                    |                    | 3   |
| GU1305L              | 0,60 pvc       |                     |                    |                    | 3   | GUM088M              | 0,84 pvc       |                     |                    |                    | 3   |
| GU1305T              | 0,26 pvc       |                     |                    |                    | 3   | GUM104               | 0,82 pvc       |                     |                    |                    | 3   |
| GU1311               | 0,18 pvc       |                     |                    |                    | 3   | GUM105               | 0,87 pvc       |                     |                    |                    | 3   |
| GU1311R              | 0,10 pvc       |                     |                    |                    | 3   | GUM145               | 0,41 pvc       |                     |                    |                    | 6   |
| GUM020               | 0,58 pvc       |                     |                    |                    | 3   |                      |                |                     |                    |                    |     |

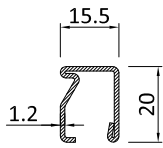

PR2007

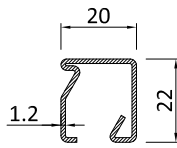

PR1007

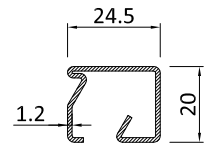

PR2008

MATERIALE | MATERIAL

PR \_\_\_\_ ZN acciaio zincato | *galvanized steel*

PR \_\_\_\_ CZ acciaio corten grezzo | *untreated corteen steel*

PR \_\_\_\_ SB acciaio inox scotch brite | *stainless steel scotch brite - AISI 316*

PR \_\_\_\_ ST acciaio inox satinato | *satin-finished stainless steel - AISI 304*

PR \_\_\_\_ L3 acciaio inox lucido | *polished stainless steel - AISI 316*

PR \_\_\_\_ BR ottone grezzo | *untreated brass*

| Profilo / Profile<br>n° | P<br>Kg/m   |      | A<br>m <sup>2</sup> /m | Jx<br>cm <sup>4</sup> | Jy<br>cm <sup>4</sup> | L<br>m |
|-------------------------|-------------|------|------------------------|-----------------------|-----------------------|--------|
|                         | ZN / I - CT | OT   |                        |                       |                       |        |
| PR2007                  | 0,57        | 0,62 | 0,13                   |                       |                       | 6      |
| PR1007                  | 0,70        | 0,75 | 0,16                   |                       |                       | 6      |
| PR2008                  | 0,75        | 0,82 | 0,17                   |                       |                       | 6      |

| Profilo / Profile<br>n° | P<br>Kg/m   |    | A<br>m <sup>2</sup> /m | Jx<br>cm <sup>4</sup> | Jy<br>cm <sup>4</sup> | L<br>m |
|-------------------------|-------------|----|------------------------|-----------------------|-----------------------|--------|
|                         | ZN / I - CT | OT |                        |                       |                       |        |
|                         |             |    |                        |                       |                       |        |
|                         |             |    |                        |                       |                       |        |
|                         |             |    |                        |                       |                       |        |

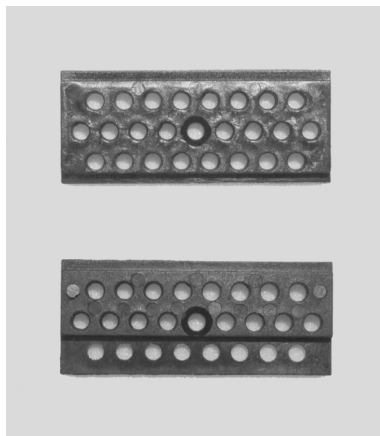
**AC1020XL**

Supporto per spessore vetro su ante con vetro superiore a 42 mm

*Glass spacer on sashes with glass over 42 mm*

**AC1020XS**

Supporto per spessore vetro su ante con vetro fino a 42 mm

*Glass spacer on sashes with glass up to 42 mm*

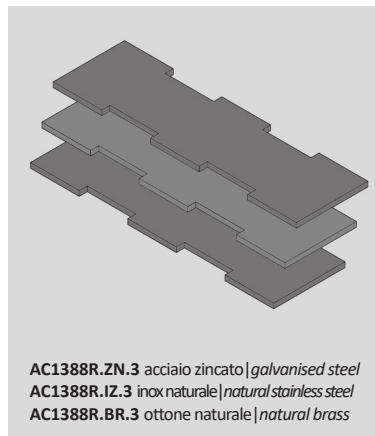
**AC1388R.xx.3**

Piatti di fissaggio carrelli su ante con profili ridotti PR1305 di larghezza > 1900 mm

*Fixing plates for rollers on reduced leaf profiles PR1305 width > 1900 mm*

AC1388R.ZN.3 acciaio zincato | galvanised steel  
AC1388R.IZ.3 inox naturale | natural stainless steel  
AC1388R.BR.3 ottone naturale | natural brass

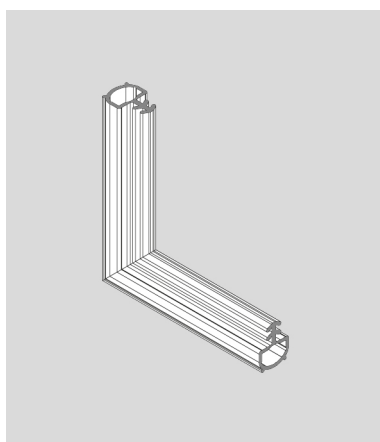
**AC1305G**

Guarnizione d'angolo vulcanizzata per GE1305S

*Vulcanised corner weather strip for GE1305S*

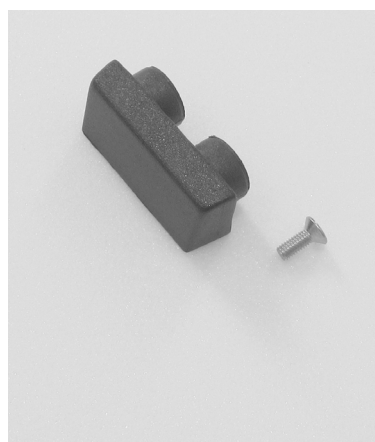
**AC 2618NE**

Scarico acqua per profilo contenimento pattini magnetici PRM195 - PRM195M

*Water drain for or profile support for magnetic device PRM195 - PRM195M*

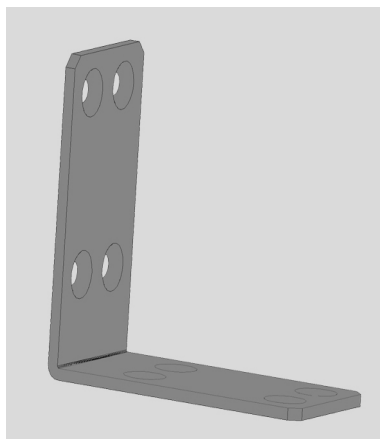
**AC1363R**

Rinforzo giunzione d'angolo su ante con profili ridotti

*Corner joint reinforcement on reduced leaf profiles*

solo per ottone  
*only for brass*

**AC2993P**

Accessorio assemblaggio telaio PR2986

*Frame assembling accessory PR2986*

**AC2993PM**

Accessorio assemblaggio telaio PR2987.2

*Frame assembling accessory PR2987.2*

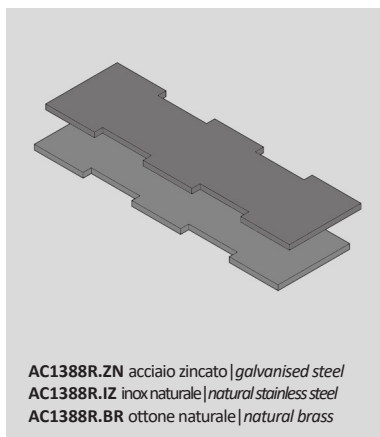
**AC1388R.xx**

Piatti di fissaggio carrelli su ante con profili ridotti PR1305 di larghezza < 1900 mm

*Fixing plates for rollers on reduced leaf profiles PR1305 width < 1900 mm*

AC1388R.ZN acciaio zincato | galvanised steel  
AC1388R.IZ inox naturale | natural stainless steel  
AC1388R.BR ottone naturale | natural brass

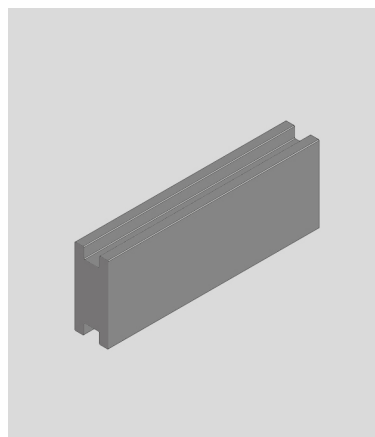
**ACM195**

Accessorio assemblaggio profilo contenimento pattini magnetici PRM195

*Accessory for profile support for magnetic device PRM195*

**AG2992.AB**

Rostro aggiuntio

*Additional hook bolt***AG2992.EF**Rostro aggiuntio per  
soluzione coassiale*Additional hook bolt on coaxial  
leaf solution***CV5001.**

Vite per boccola fermavetri

*Screw for glazing bead bushing*

TPS 4.2x16 mm

**CV5012.**

Boccola per fermavetri

*Bushing for glazing bead*

CV5001 acciaio zincato | *galvanized steel*  
CV50011 acciaio inox | *stainless steel*

CV5012 acciaio zincato | *galvanized steel*  
CV50121 acciaio inox | *stainless steel*

Tabella determinazione range dimensione ante per ordine kit movimentazione e tenuta

Table for sash range for the order of the handling and sealing kit

|                    |                  | altezza - height |              |              |              |                     | KIT STANDARD<br>STANDARD KIT |             |            |            |            | KIT MAGGIORATO<br>INCREASED KIT |                              |             |             |             |   |   |
|--------------------|------------------|------------------|--------------|--------------|--------------|---------------------|------------------------------|-------------|------------|------------|------------|---------------------------------|------------------------------|-------------|-------------|-------------|---|---|
|                    |                  |                  |              |              |              |                     | peso anta - sash weight [kg] |             |            |            |            | peso anta - sash weight [kg]    |                              |             |             |             |   |   |
|                    |                  | <b>.XX</b>       | 2365<br>2600 | 2601<br>2950 | 2951<br>3300 | 3301<br>3600        | <b>.n</b>                    | 160<br>210  | 240<br>315 | 320<br>420 | 400<br>525 | 480<br>630                      | <b>.n</b>                    | 400<br>560  | 600<br>840  | 800<br>1000 |   |   |
| larghezza<br>width | <b>800-1900</b>  | A1               | B1           | C1           | D1           | larghezza<br>minima | <b>800</b>                   | 2           | -          | -          | -          | -                               | larghezza<br>minima<br>width | <b>1140</b> | 7           | -           | - |   |
|                    | <b>1901-3500</b> | A2               | B2           | C2           | D2           |                     | <b>1150</b>                  | 2           | 3          | -          | -          | -                               |                              | <b>1660</b> | 7           | 8           | - |   |
|                    |                  |                  |              |              |              |                     | minimum<br>width             | <b>1500</b> | 2          | 3          | 4          | -                               | -                            | <b>2180</b> | 7           | 8           | 9 |   |
|                    |                  |                  |              |              |              |                     |                              | <b>1850</b> | 2          | 3          | 4          | 5                               | -                            |             | <b>2200</b> | 2           | 3 | 4 |

Schema | Type A

**AGM 086A.xx.n**  
Kit movimentazione e tenuta  
1 anta apribile - anta dx  
Profili MAGGIORATI  
1 leaf handling and sealing kit  
RH sash  
STANDARD profiles

**AGM 386A.xx.n**  
Kit movimentazione e tenuta  
1 anta apribile - anta dx  
Profili RIDOTTI  
1 leaf handling and sealing kit  
RH sash  
REDUCED profiles

Schema | Type B

**AGM 087B.xx.n**  
Kit movimentazione e tenuta 2  
ante apribili - 1^ anta sx  
Profili MAGGIORATI  
2 leaf handling and sealing  
kit - LH master  
STANDARD profiles

**AGM 387B.xx.n**  
Kit movimentazione e tenuta 2  
ante apribili - 1^ anta sx  
Profili RIDOTTI  
2 leaf handling and sealing  
kit - LH master  
REDUCED profiles

Schema | Type A

**AGM 087A.xx.n**  
Kit movimentazione e tenuta  
1 anta apribile - anta sx  
Profili MAGGIORATI  
1 leaf handling and sealing kit  
LH sash  
STANDARD profiles

**AGM 387A.xx.n**  
Kit movimentazione e tenuta  
1 anta apribile - anta sx  
Profili RIDOTTI  
1 leaf handling and sealing kit  
LH sash  
REDUCED profiles

Schema | Type C

**AGM 386C.xx.n**  
Kit movimentazione e tenuta 1  
anta apribile continua - anta dx  
  
1 continuous leaf handling and  
sealing kit - RH

Schema | Type B

**AGM 086B.xx.n**  
Kit movimentazione e tenuta 2  
ante apribili - 1^ anta dx  
Profili MAGGIORATI  
2 leaf handling and sealing  
kit - RH master  
STANDARD profiles

**AGM 386B.xx.n**  
Kit movimentazione e tenuta 2  
ante apribili - 1^ anta dx  
Profili RIDOTTI  
2 leaf handling and sealing  
kit - RH master  
REDUCED profiles

Schema | Type C

**AGM 387C.xx.n**  
Kit movimentazione e tenuta 1  
anta apribile continua - anta sx  
  
1 continuous leaf handling and  
sealing kit - LH



Schema | Type E

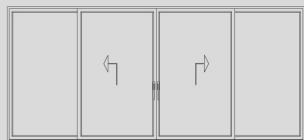

### AGM 086E.xx

Kit movimentazione e tenuta 2 ante apribili  
Profili MAGGIORATI  
2 leaf handling and sealing kit  
STANDARD profiles

### AGM 386E.xx

Kit movimentazione e tenuta 2 ante apribili  
Profili RIDOTTI  
2 leaf handling and sealing kit  
REDUCED profiles

Schema | Type B3

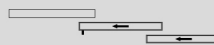

### AGM 086B3.xx.n

Kit movimentazione e tenuta 3 ante apribili - 1^a anta dx  
Profili MAGGIORATI  
3 leaf handling and sealing kit - RH master  
STANDARD profiles

### AGM 386B3.xx.n

Kit movimentazione e tenuta 3 ante apribili - 1^a anta dx  
Profili RIDOTTI  
3 leaf handling and sealing kit - RH master  
REDUCED profiles

Schema | Type F

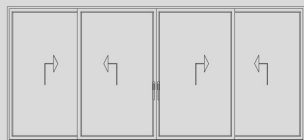

### AGM 086F.xx

Kit movimentazione e tenuta 4 ante apribili  
Profili MAGGIORATI  
4 leaf handling and sealing kit  
STANDARD profiles

### AGM 386F.xx

Kit movimentazione e tenuta 4 ante apribili  
Profili RIDOTTI  
4 leaf handling and sealing kit  
REDUCED profiles

Schema | Type B3

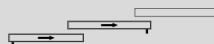
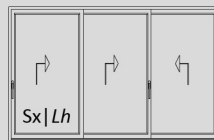

### AGM 087B3.xx.n

Kit movimentazione e tenuta 3 ante apribili - 1^a anta sx  
Profili MAGGIORATI  
3 leaf handling and sealing kit - LH master  
STANDARD profiles

### AGM 387B3.xx.n

Kit movimentazione e tenuta 3 ante apribili - 1^a anta sx  
Profili RIDOTTI  
3 leaf handling and sealing kit - LH master  
REDUCED profiles

Schema | Type A3

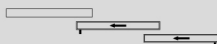

### AGM 086A3.xx.n

Kit movimentazione e tenuta 2 ante apribili - 1^a anta dx  
Profili MAGGIORATI  
2 leaf handling and sealing kit - RH master  
STANDARD profiles

### AGM 386A3.xx.n

Kit movimentazione e tenuta 2 ante apribili - 1^a anta dx  
Profili RIDOTTI  
2 leaf handling and sealing kit - RH master  
REDUCED profiles

Schema | Type C3

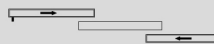
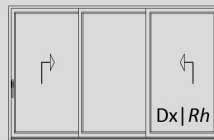

### AGM 086C3.xx.n

Kit movimentazione e tenuta 2 ante apribili - 1^a anta dx  
Profili MAGGIORATI  
2 leaf handling and sealing kit - RH master  
STANDARD profiles

### AGM 386C3.xx.n

Kit movimentazione e tenuta 2 ante apribili - 1^a anta dx  
Profili RIDOTTI  
2 leaf handling and sealing kit - RH master  
REDUCED profiles

Schema | Type A3



### AGM 087A3.xx.n

Kit movimentazione e tenuta 2 ante apribili - 1^a anta sx  
Profili MAGGIORATI  
2 leaf handling and sealing kit - LH master  
STANDARD profiles

### AGM 387A3.xx.n

Kit movimentazione e tenuta 2 ante apribili - 1^a anta sx  
Profili RIDOTTI  
2 leaf handling and sealing kit - LH master  
REDUCED profiles

Schema | Type C3

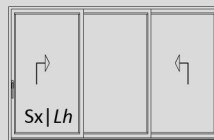

### AGM 087C3.xx.n

Kit movimentazione e tenuta 2 ante apribili - 1^a anta sx  
Profili MAGGIORATI  
2 leaf handling and sealing kit - LH master  
STANDARD profiles

### AGM 387C3.xx.n

Kit movimentazione e tenuta 2 ante apribili - 1^a anta sx  
Profili RIDOTTI  
2 leaf handling and sealing kit - LH master  
REDUCED profiles

Schema | Type E3

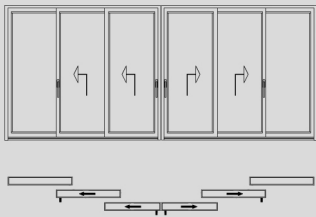

**AGM 086E3.xx.n**

Kit movimentazione e tenuta 4 ante apribili  
Profili MAGGIORATI  
4 leaf handling and sealing kit  
STANDARD profiles

**AGM 386E3.xx.n**

Kit movimentazione e tenuta 4 ante apribili  
Profili RIDOTTI  
4 leaf handling and sealing kit  
REDUCED profiles

Schema | Type S2

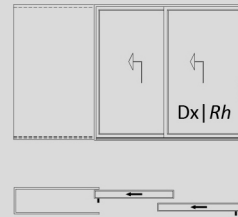

**AGM 086S2.xx.n**

Kit movimentazione e tenuta 2 ante apribili a scomparsa - 1^ dx  
Profili MAGGIORATI  
2 concealed leaf handling and sealing kit - RH master  
STANDARD profiles

**AGM 386S2.xx.n**

Kit movimentazione e tenuta 2 ante apribili a scomparsa - 1^ dx  
Profili RIDOTTI  
2 concealed leaf handling and sealing kit - RH master  
REDUCED profiles

Schema | Type F3

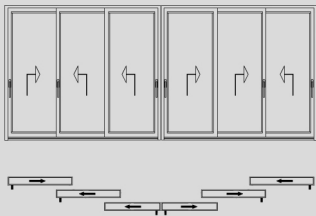

**AGM 086F3.xx.n**

Kit movimentazione e tenuta 6 ante apribili  
Profili MAGGIORATI  
6 leaf handling and sealing kit  
STANDARD profiles

**AGM 386F3.xx.n**

Kit movimentazione e tenuta 6 ante apribili  
Profili RIDOTTI  
6 leaf handling and sealing kit  
REDUCED profiles

Schema | Type S2

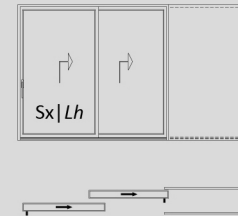

**AGM 087S2.xx.n**

Kit movimentazione e tenuta 2 ante apribili a scomparsa - 1^ sx  
Profili MAGGIORATI  
2 concealed leaf handling and sealing kit - LH master  
STANDARD profiles

**AGM 387S2.xx.n**

Kit movimentazione e tenuta 2 ante apribili a scomparsa - 1^ sx  
Profili RIDOTTI  
2 concealed leaf handling and sealing kit - LH master  
REDUCED profiles

Schema | Type S1



**AGM 086S1.xx.n**

Kit movimentazione e tenuta 1 anta ap. scomparsa - anta dx  
Profili MAGGIORATI  
1 concealed leaf handling and sealing kit - RH sash  
STANDARD profiles

**AGM 386S1.xx.n**

Kit movimentazione e tenuta 1 anta ap. scomparsa - anta dx  
Profili RIDOTTI  
1 concealed leaf handling and sealing kit - RH sash  
REDUCED profiles

Schema | Type S3

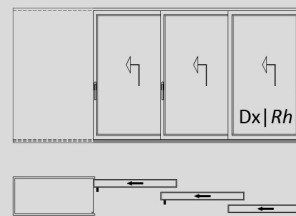

**AGM 086S3.xx.n**

Kit movimentazione e tenuta 3 ante apribili a scomparsa - 1^ dx  
Profili MAGGIORATI  
3 concealed leaf handling and sealing kit - RH master  
STANDARD profiles

**AGM 386S3.xx.n**

Kit movimentazione e tenuta 3 ante apribili a scomparsa - 1^ dx  
Profili RIDOTTI  
3 concealed leaf handling and sealing kit - RH master  
REDUCED profiles

Schema | Type S1



**AGM 087S1.xx.n**

Kit movimentazione e tenuta 1 anta ap. scomparsa - anta sx  
Profili MAGGIORATI  
1 concealed leaf handling and sealing kit - LH sash  
STANDARD profiles

**AGM 387S1.xx.n**

Kit movimentazione e tenuta 1 anta ap. scomparsa - anta sx  
Profili RIDOTTI  
1 concealed leaf handling and sealing kit - LH sash  
REDUCED profiles

Schema | Type S3

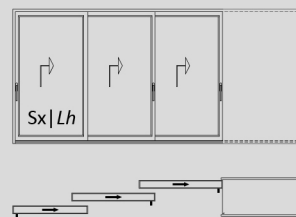

**AGM 087S3.xx.n**

Kit movimentazione e tenuta 3 ante apribili a scomparsa - 1^ sx  
Profili MAGGIORATI  
3 concealed leaf handling and sealing kit - LH master  
STANDARD profiles

**AGM 387S3.xx.n**

Kit movimentazione e tenuta 3 ante apribili a scomparsa - 1^ sx  
Profili RIDOTTI  
3 concealed leaf handling and sealing kit - LH master  
REDUCED profiles

Schema | Type T1

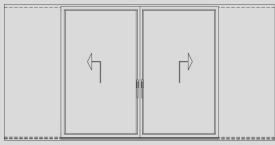
**AGM 086T1.xx.n**

Kit movimentazione e tenuta 2  
ante apribili a scomparsa  
Profili MAGGIORATI  
*2 concealed leaf handling and  
sealing kit*  
STANDARD profiles

**AGM 386T1.xx.n**

Kit movimentazione e tenuta 2  
ante apribili a scomparsa  
Profili RIDOTTI  
*2 concealed leaf handling and  
sealing kit*  
REDUCED profiles

Schema | Type T2

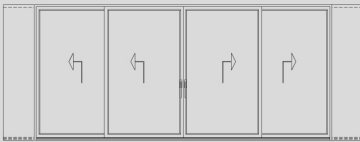
**AGM 086T2.xx.n**

Kit movimentazione e tenuta 4  
ante apribili a scomparsa  
Profili MAGGIORATI  
*4 concealed leaf handling and  
sealing kit*  
STANDARD profiles

**AGM 386T2.xx.n**

Kit movimentazione e tenuta 4  
ante apribili a scomparsa  
Profili RIDOTTI  
*4 concealed leaf handling and  
sealing kit*

Schema | Type T3

**AGM 086T3.xx**

Kit movimentazione e tenuta 6  
ante apribili a scomparsa  
Profili MAGGIORATI  
*6 concealed leaf handling and  
sealing kit*  
STANDARD profiles

**AGM 386T3.xx**

Kit movimentazione e tenuta 6  
ante apribili a scomparsa  
Profili RIDOTTI  
*6 concealed leaf handling and  
sealing kit*  
REDUCED profiles

## MOTORIZZAZIONI

## MGM - - - - .xx.n

Kit di movimentazione e tenuta per ante motorizzabili - *Handling and sealing kits for motorized sashes*Attribuire il codice MGM tramite i range di utilizzo dei kit manuali AGM - *Assign the MGM code using the ranges of use of AGM manual kits*KIT MOTORIZZAZIONI - *MOTORISATION KIT*

| SCHEMA<br>TYPE          | MOTORE<br>MOTOR | LARGHEZZA ANTA<br>SASH WIDTH |                        | LUNGHEZZA MOTORE<br>MOTOR LENGTH |
|-------------------------|-----------------|------------------------------|------------------------|----------------------------------|
|                         |                 | maggiorato - <i>standard</i> | ridotto - <i>small</i> |                                  |
| A<br>B<br>C<br>C3<br>S1 | MG S 140        | 1143 - 1494                  | 1130 - 1469            | 2174                             |
|                         | MG S 200        | 1443 - 1430                  | 2094 - 2069            | 2774                             |
|                         | MG S 320        | 2043 - 3294                  | 2030 - 3269            | 3974                             |
|                         | MG M 400        | 2543 - 4094                  | 2530 - 4069            | 4974                             |
|                         | MG X 140        | 1106 - 1494                  | 1094 - 1469            | 3974                             |
| E<br>F<br>T1            | MG X 190        | 1356 - 1994                  | 1344 - 1969            | 2774                             |
|                         | MG X 240        | 1606 - 2494                  | 1594 - 2469            | 3974                             |
|                         | MG S 142        | 1144 - 1494                  | 1131 - 1469            | 2 x 2174                         |
|                         | MG S 202        | 1444 - 2094                  | 1431 - 2069            | 2 x 2774                         |
|                         | MG S 322        | 2044 - 3294                  | 2031 - 3269            | 2 x 3974                         |
| A3<br>B3<br>S2          | MG M 200.1      | 1070 - 1094                  | 1053 - 1069            | 2974                             |
|                         | MG M 300.1      | 1403 - 1594                  | 1386 - 1569            | 3974                             |
|                         | MG M 400.1      | 1736 - 2094                  | 1720 - 2069            | 4974                             |
|                         | MG M 500.2      | 2070 - 2594                  | 2053 - 2569            | 5974                             |
|                         | MG M 600.2      | 2403 - 3094                  | 2386 - 3069            | 6974                             |
| S3                      | MG M 300.2      | 1069 - 1094                  | 1050 - 1069            | 3974                             |
|                         | MG M 400.2      | 1319 - 1427                  | 1300 - 1402            | 4974                             |
|                         | MG M 500.3      | 1569 - 1761                  | 1550 - 1736            | 5974                             |
|                         | MG M 600.3      | 1819 - 2095                  | 1800 - 2070            | 6974                             |
| E3<br>F3<br>T2          | MG M 202.1      | 1061 - 1094                  | 1044 - 1069            | 2 x 2974                         |
|                         | MG M 302.1      | 1394 - 1594                  | 1377 - 1569            | 2 x 3974                         |
|                         | MG M 402.1      | 1727 - 2094                  | 1711 - 2069            | 2 x 4974                         |
|                         | MG M 502.2      | 2061 - 2594                  | 2044 - 2569            | 2 x 5974                         |
|                         | MG M 602.2      | 2394 - 3094                  | 2377 - 3069            | 2 x 6974                         |
| T3                      | MG M 302.2      | 1071 - 1094                  | 1052 - 1069            | 2 x 3974                         |
|                         | MG M 402.2      | 1321 - 1427                  | 1302 - 1402            | 2 x 4974                         |
|                         | MG M 502.3      | 1571 - 1760                  | 1552 - 1735            | 2 x 5974                         |
|                         | MG M 602.3      | 1821 - 2093                  | 1802 - 2068            | 2 x 6974                         |

NOTE - le motorizzazioni per dimensioni anta non riportate in tabella vengono fornite su richiesta

NOTES - the motorizations for sash dimensions not shown in the table are supplied on request

Profili | Profiles

Prospetto | View  
Vista interna | Internal view

Tipo | Type M-M

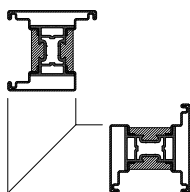

Tipo | Type R-R

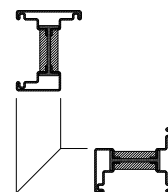

Schema | Type A-B

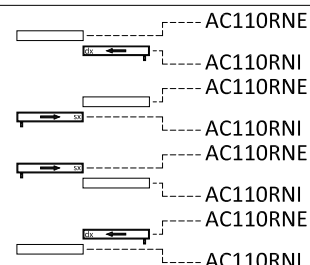
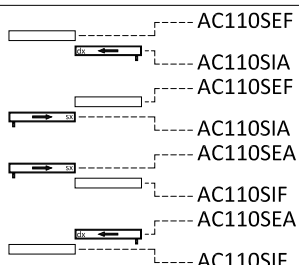
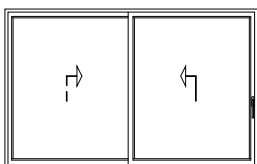

Schema | Type C

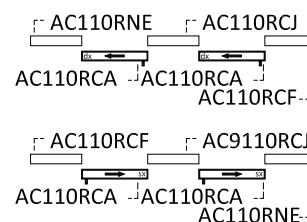
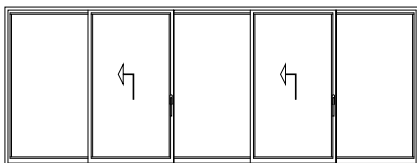

Schema | Type E-F

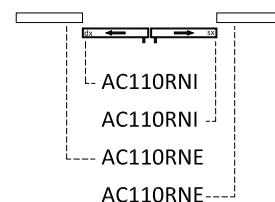
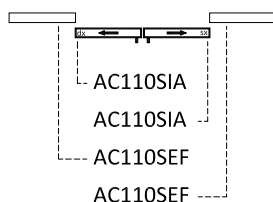
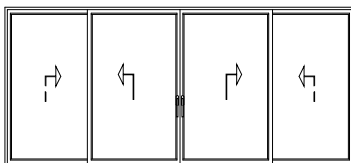

Schema | Type A3-B3

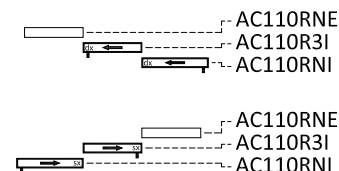
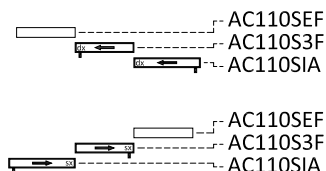
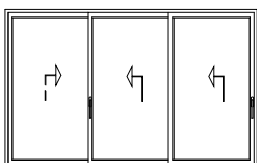

Schema | Type C3

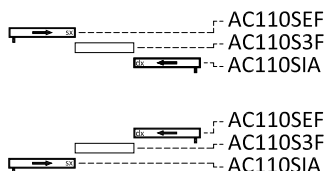
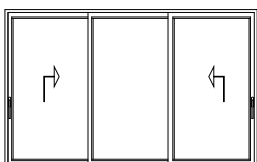

Schema | Type E3-F3

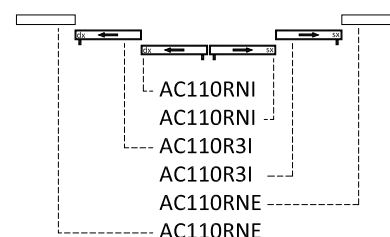
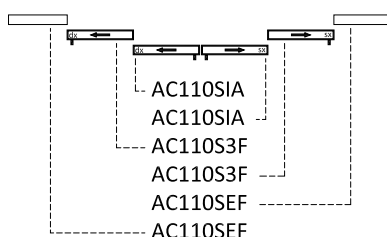
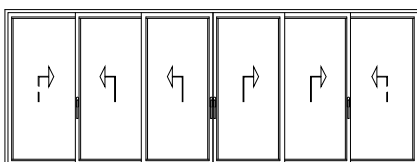

Profili | Profiles

Prospetto | View  
Vista interna | Internal view

Tipo | Type M-M

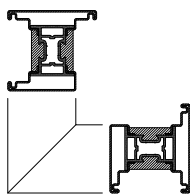

Tipo | Type R-R

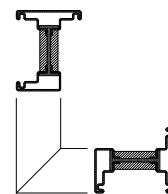

Schema | Type S1

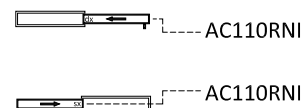
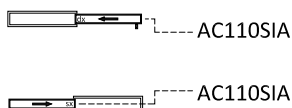
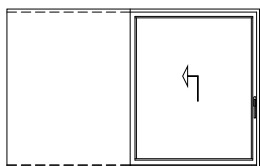

Schema | Type S2

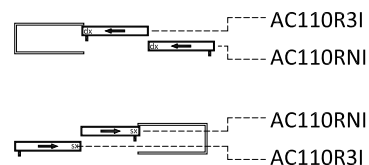
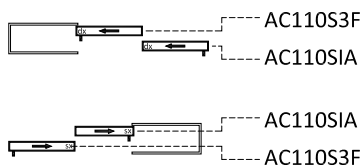
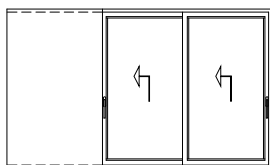

Schema | Type S3

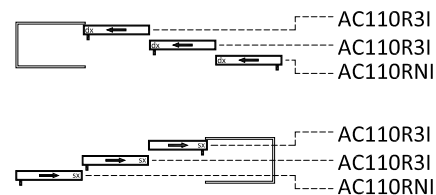
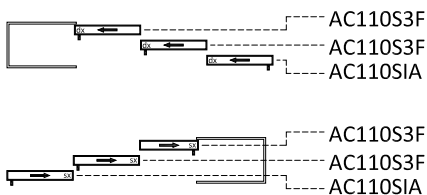
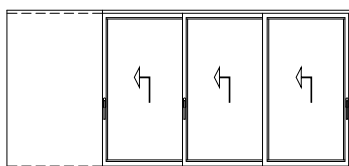

Schema | Type T1

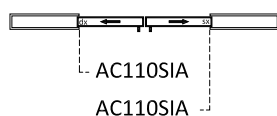
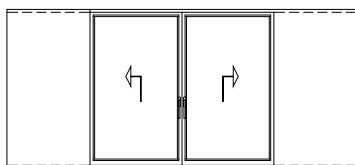

Schema | Type T2

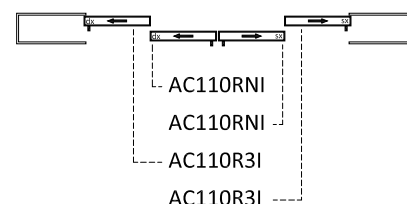
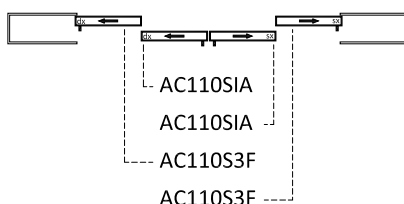
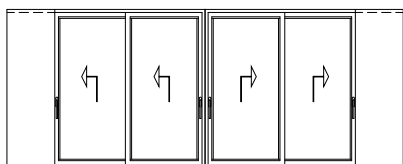

Schema | Type T3

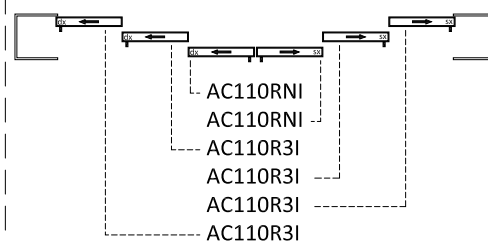
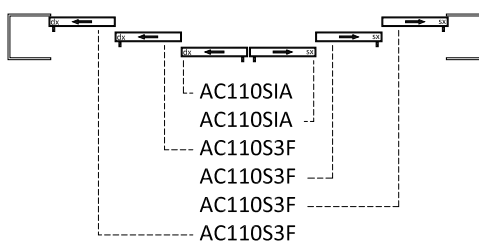
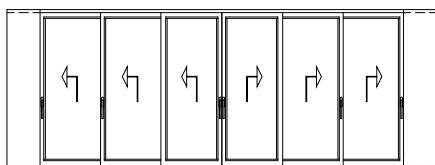

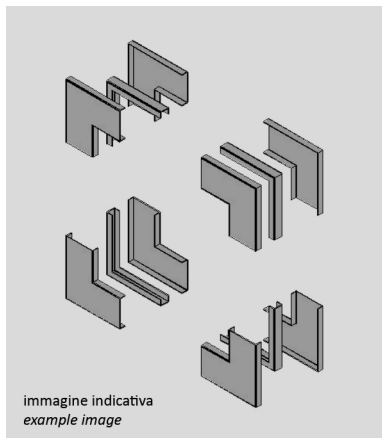

## AC 110 RCA

Kit squadrette di giunzione angoli  
Acciaio inox

*Corner joint kit  
Stainless steel*

Vedi tabella | See chart  
pg. 2.4.1-2

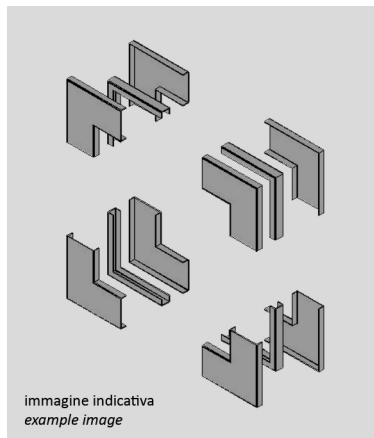

## AC 110 RNI

Kit squadrette di giunzione angoli  
Acciaio inox

*Corner joint kit  
Stainless steel*

Vedi tabella | See chart  
pg. 2.4.1-2

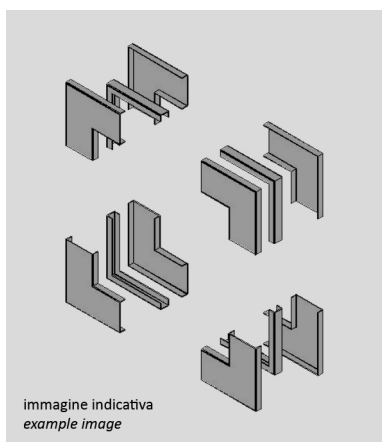

## AC 110 RCF

Kit squadrette di giunzione angoli  
Acciaio inox

*Corner joint kit  
Stainless steel*

Vedi tabella | See chart  
pg. 2.4.1-2

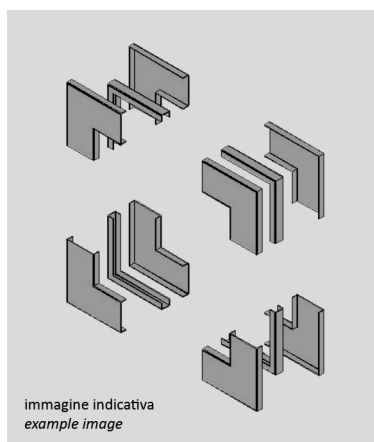

## AC 110 R3I

Kit squadrette di giunzione angoli  
Acciaio inox

*Corner joint kit  
Stainless steel*

Vedi tabella | See chart  
pg. 2.4.1-2

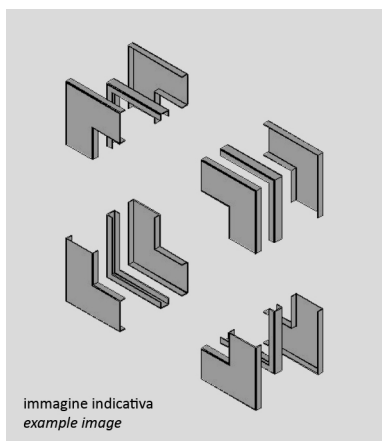

## AC 110 RCJ

Kit squadrette di giunzione angoli  
Acciaio inox

*Corner joint kit  
Stainless steel*

Vedi tabella | See chart  
pg. 2.4.1-2

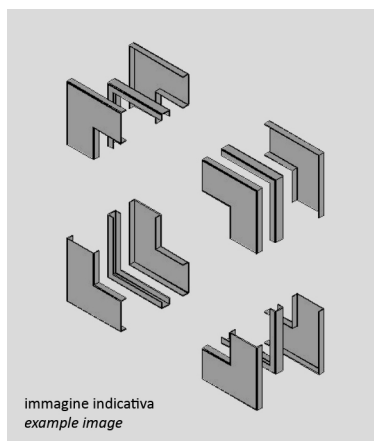

## AC 110 SEA

Kit squadrette di giunzione angoli  
Acciaio inox

*Corner joint kit  
Stainless steel*

Vedi tabella | See chart  
pg. 2.4.1-2

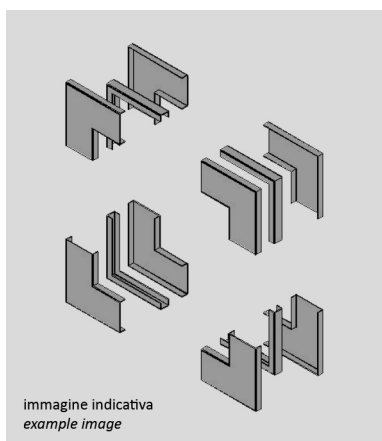

## AC 110 RNE

Kit squadrette di giunzione angoli  
Acciaio inox

*Corner joint kit  
Stainless steel*

Vedi tabella | See chart  
pg. 2.4.1-2

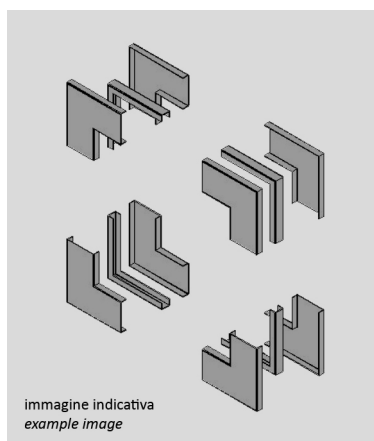

## AC 110 SEF

Kit squadrette di giunzione angoli  
Acciaio inox

*Corner joint kit  
Stainless steel*

Vedi tabella | See chart  
pg. 2.4.1-2

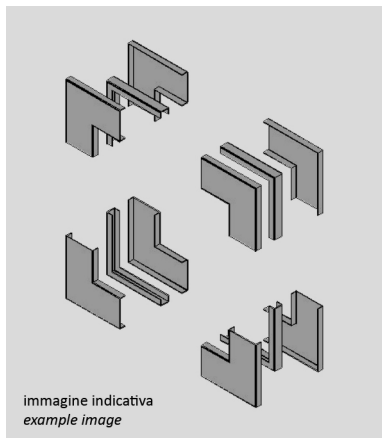

## AC 110 SIA

Kit squadrette di giunzione angoli  
Acciaio inox

*Corner joint kit  
Stainless steel*

Vedi tabella | See chart  
pg. 2.4.1-2



## AC 292 SPI

Kit per giunzione angolo telaio  
Acciaio inox

*Frame corner joint kit  
Stainless steel*

PR1320  
PR1320M

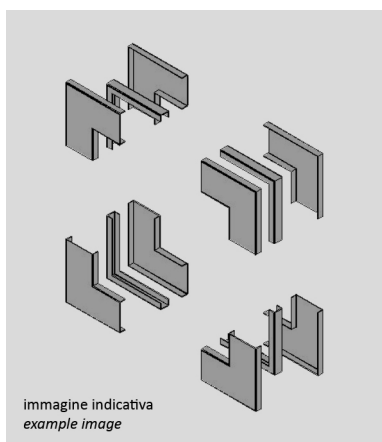

## AC 110 SIF

Kit squadrette di giunzione angoli  
Acciaio inox

*Corner joint kit  
Stainless steel*

Vedi tabella | See chart  
pg. 2.4.1-2

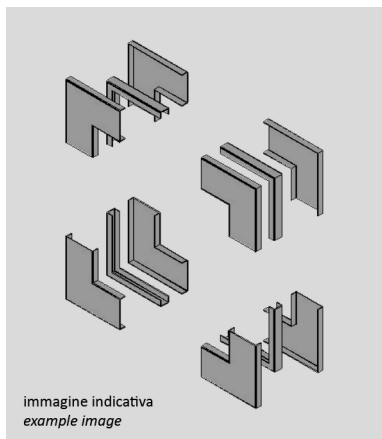

## AC 110 S3F

Kit squadrette di giunzione angoli  
Acciaio inox

*Corner joint kit  
Stainless steel*

Vedi tabella | See chart  
pg. 2.4.1-2



## AC 290 SPI

Kit per giunzione angolo telaio  
Acciaio inox

*Frame corner joint kit  
Stainless steel*

PR2986  
PR2987.2  
PR2986L.3  
PR2986.3  
PR2987.3



**ACV 068.xx**

Maniglione singolo "VITRUVIO"  
L | tonda | tronca  
Ø18

*Single "VITRUVIO" handle  
L | round | cut  
Ø18*

**ZN** acciaio zincato | *galvanized steel*  
**SB** acciaio inox | *stainless steel*  
**CZ** acciaio corten | *corten steel*  
**BR** ottone | *brass*

**AC 1096.xx**

Maniglione singolo in ottone  
con vaschetta esterna

*Single brass handle with  
external cabinet pull handle*

**BB** ottone brunito | *burnished brass*  
**BR** ottone grezzo | *untreated brass*  
**CL** ottone cromo lucido  
*polished and chromed brass*  
**OL** ottone lucido | *polished brass*

**ACV 068Y.xx**

Maniglione singolo "VITRUVIO"  
con con foro chiave europea  
L | tonda | tronca  
Ø18

*Single "VITRUVIO" handle  
with European key hole  
L | round | cut  
Ø18*

**ZN** acciaio zincato | *galvanized steel*  
**SB** acciaio inox | *stainless steel*  
**CZ** acciaio corten | *corten steel*  
**BR** ottone | *brass*

**AC 1096P.xx**

Copertina in acciaio inox per  
maniglione singolo con foro  
chiave europea

*Stainless steel cover for single  
handle with European key hole*

**ST** acciaio inox AISI 304 satinato  
*satined stainless steel AISI 304*  
**SB** acciaio inox AISI 316 scotch brite  
*scotch brite stainless steel AISI 316*  
**BB** ottone brunito | *burnished brass*  
**BR** ottone grezzo | *untreated brass*  
**CL** ottone cromo lucido  
*polished and chromed brass*  
**OL** ottone lucido | *polished brass*

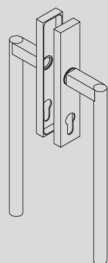
**ACV 168Y.xx**

Maniglione doppio "VITRUVIO"  
L | tonda | tronca  
Ø18

*Double "VITRUVIO" handle  
L | round | cut  
Ø18*

**ZN** acciaio zincato | *galvanized steel*  
**SB** acciaio inox | *stainless steel*  
**CZ** acciaio corten | *corten steel*  
**BR** ottone | *brass*

**AC 1097.xx**

Maniglione doppio in  
acciaio inox

*Stainless steel double handle*

**ST** acciaio inox AISI 304 satinato  
*satined stainless steel AISI 304*  
**SB** acciaio inox AISI 316 scotch brite  
*scotch brite stainless steel AISI 316*

**AC 1096.xx**

Maniglione singolo in acciaio  
inox con vaschetta esterna

*Stainless steel single handle with  
external cabinet pull handle*

**ST** acciaio inox AISI 304 satinato  
*satined stainless steel AISI 304*  
**SB** acciaio inox AISI 316 scotch brite  
*scotch brite stainless steel AISI 316*

**AC 1097.xx**

Maniglione doppio in ottone

*Brass double handle*

**BB** ottone brunito | *burnished brass*  
**BR** ottone grezzo | *untreated brass*  
**CL** ottone cromo lucido  
*polished and chromed brass*  
**OL** ottone lucido | *polished brass*

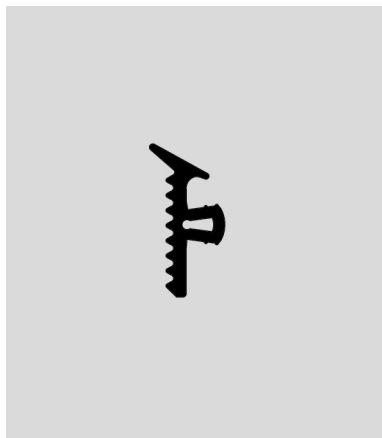

**GE 1006**

Guarnizione esterna vetro

*External gasket*

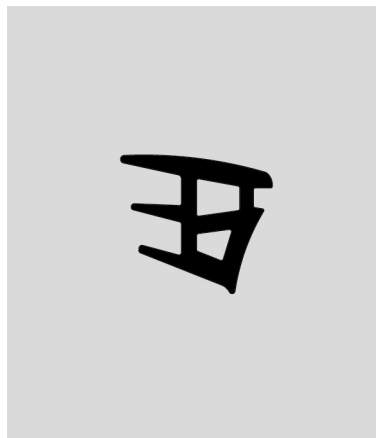

**GE 1013**

Guarnizione interna fermavetro spessore 12-16 mm

*Internal gasket on 12-16 mm thick glazing bead*

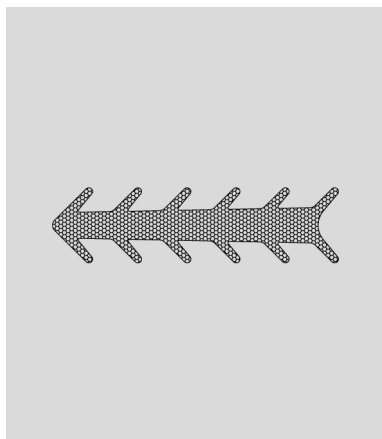

**GE 1007TT**

Guarnizione sotto vetro

*Under glass gasket*

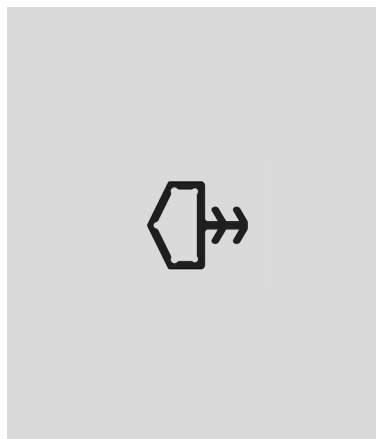

**GE 1142**

Guarnizione di tenuta labirinto

*Labyrinth sealing gasket*



**GE 1011**

Guarnizione interna fermavetro spessore 3-4 mm

*Internal gasket on 3-4 mm thick glazing bead*

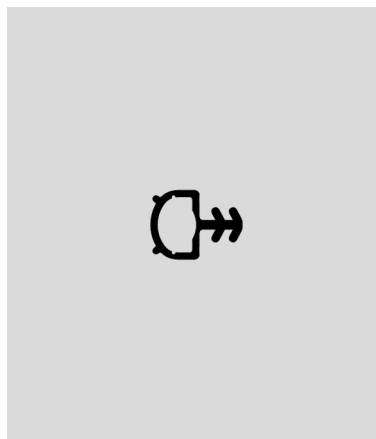

**GE 1305S**

Guarnizione laterale e inferiore ante

*Sash uproghts an bottom rail gasket*

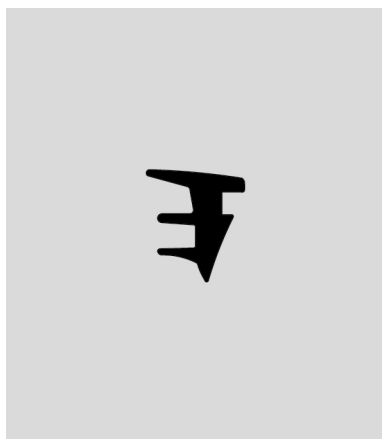

**GE 1012**

Guarnizione interna fermavetro spessore 6-8 mm

*Internal gasket on 6-8 mm thick glazing bead*

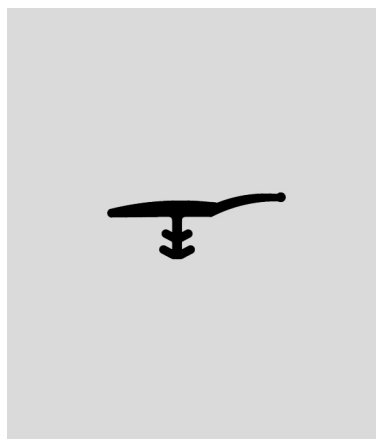

**GE 2905S**

Guarnizione superiore ante

*Top-rail gasket*

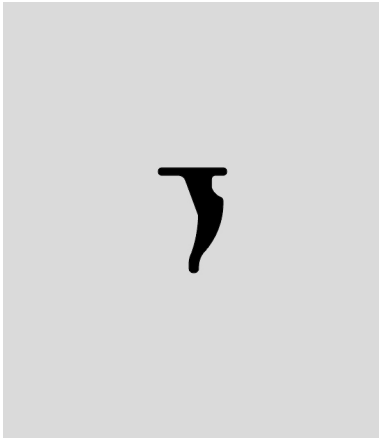
**GP 0095**

Guarnizione interna fermavetro  
spessore 3 mm

*Internal glass gasket - 3 mm  
thick*

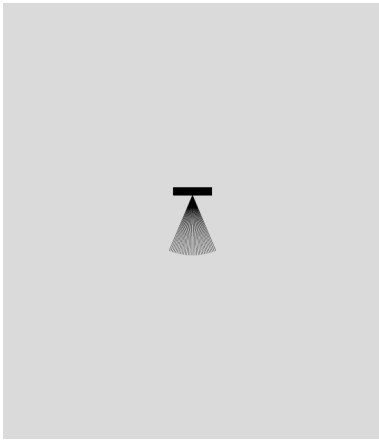
**GU 0087**

Spazzolino per labirinto e per  
profilo PAM191  
H=8 mm

*Brush for labyrinth joint and for  
PAM191 profile  
H=8 mm*

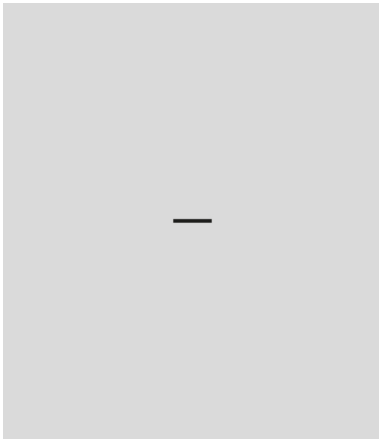
**GU 0087AD**

Adesivo per fissaggio GU0087  
su labirinto

*Adhesive tape for GU0087  
on labyrinth*

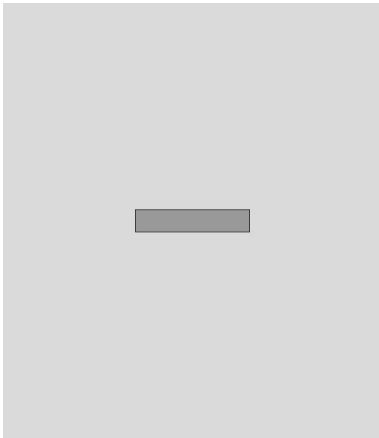
**GU 2035**

Piattina adesiva morbida  
per fondo giunto esterno vetro  
15x3 mm

*Soft adhesive shim for  
external glass joint  
15x3 mm*



## AT 1001

Maschera per esecuzione fori di fissaggio squadretta su profili maggiorati

*Jig for drilling holes for corner plate on oversize profiles*

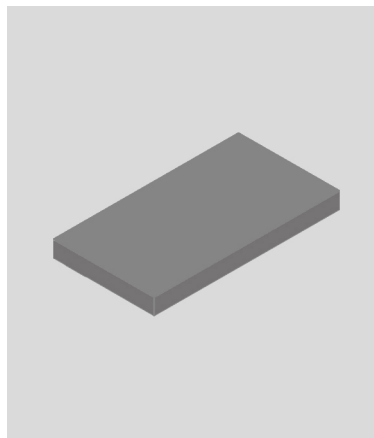

## ATM 188

Attrezzatura per verifica posizionamento anima trave interfaccia anta e pattino PAM088

*Equipment for checking the positioning of the core of the door sash interface PAM088*

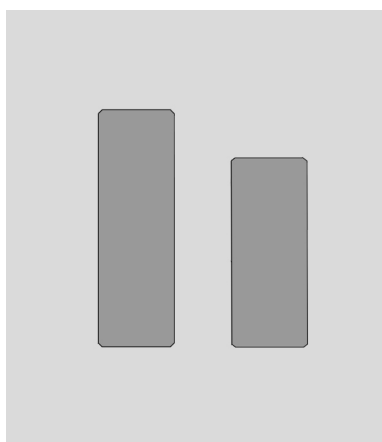

## AT 1100

Kit ganasce di taglio per profili anta

*Kit of cutting jaws for sash profiles*

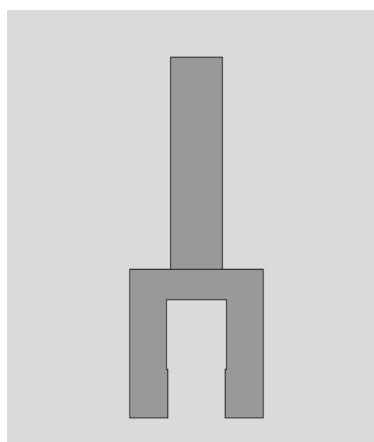

## ATM 195

Maschera foratura estruso PAM195 per posizionamento rotaia

*Jig for drilling extruded PAM195 for rail positioning*

## ATM 195M

Maschera foratura PAM195M per posizionamento rotaia

*Jig for drilling extruded PAM195M for rail positioning*

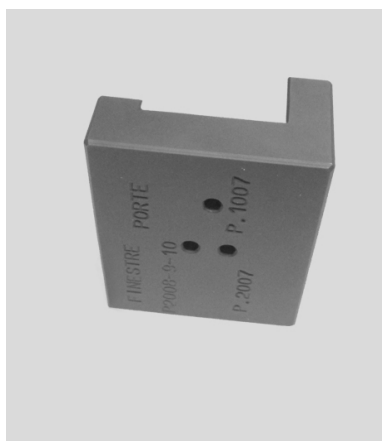

## AT 1234

Maschera per esecuzione fori fissaggio fermavetri con boccole

*Jig for drilling holes for glazing bead with bushings*

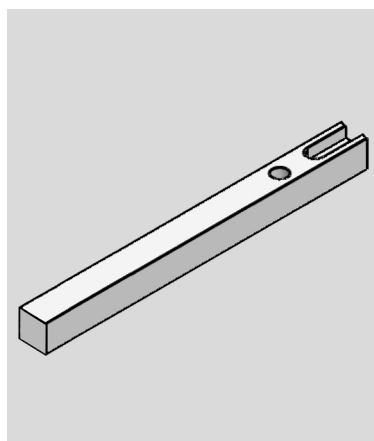

## ATM195R

Kit rotaia di inserimento per PRM195.LN

*Rail insertion kit for PRM195.LN*

## ATM195RM

Kit rotaia di inserimento per PRM195M.LN

*Rail insertion kit for PRM195M.LN*

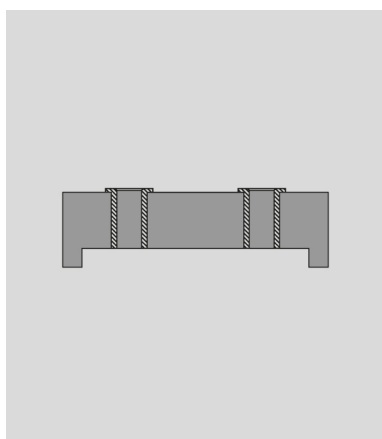

## ATM 088

Maschera foratura trave PAM088

*Jig for drilling PAM088 profile*



**SA 005/01**

Liquido neritore per brunitura  
1 Kg

*Burnishing liquid  
1 Kg*

**SA 005/10**

Liquido neritore per brunitura  
10 Kg

*Burnishing liquid  
10 Kg*



**SA 2031**

Liquido deumidificante vetri

*Glass dehumidifying liquid*

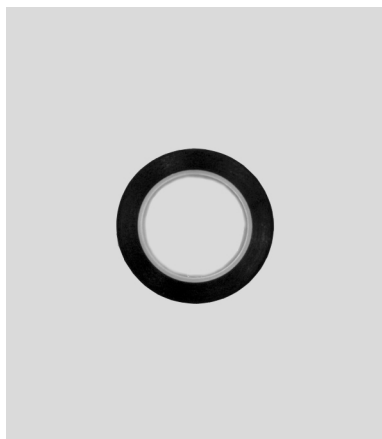

**SA 1042**

Nastro adesivo protettivo per  
verniciatura  
42 mm

*Adhesive tape for painting  
42 mm*



**SA 2032**

Primer di adesione per profili  
verniciati

*Adhesion primer for painted  
profiles*



**SA 2001**

Spray detergente antimpronta  
per superfici in acciaio inox

*Anti-fingerprint detergent spray  
for stainless steel surfaces*



**SA 2033**

Liquido di adesione per  
materiale plastico

*Adhesion liquid for plastic*



**SA 2002**

Spray solvente per rimozione  
collanti su superfici in acciaio  
inox

*Solvent adhesive remover spray  
for stainless steel surfaces*



**SA 3001**

Acido per ossidazione corten

*Oxidising acid for corten*

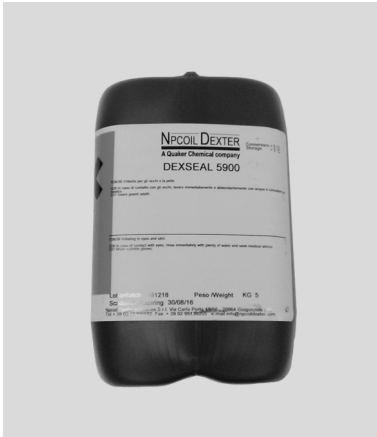

### SA 3002

Passivante per ossidazione corten  
25 Kg

*Passivating agent for corten  
25 Kg*

### SA 3002/5

Passivante per ossidazione corten  
5 Kg

*Passivating agent for corten  
5 Kg*



### SL 0022

Adesivo cianoacrilico per  
tamponi in neoprene

*Cyanoacrylic adhesive for  
neoprene pads*



### SA 3003

Cera d'api per finitura corten

*Beeswax for Corten finishing*



### SL 0019

Sigillante a freddo per giunzione  
angoli e traversi

*Cold sealant for corner and  
transom joints*

1 kg



### SL 0021

Silicone nero per guarnizioni

*Black silicone for gaskets*

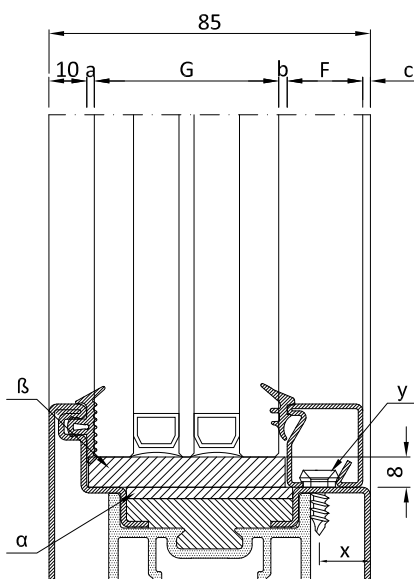



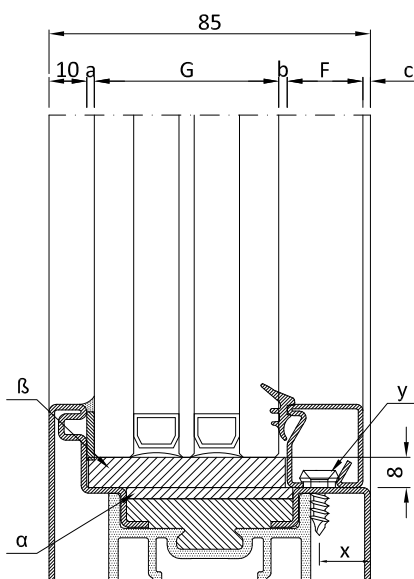

| F                          | G                          | Guarnizioni - Gaskets |                        |                        |                        |                          |  |   |   |                                  |         |
|----------------------------|----------------------------|-----------------------|------------------------|------------------------|------------------------|--------------------------|--|---|---|----------------------------------|---------|
| fermavetro<br>Glazing bead | range vetro<br>Glass range | GE1006<br>3 mm<br>    | GP0095<br>2 / 3 mm<br> | GE1011<br>3 / 4 mm<br> | GE1012<br>6 / 8 mm<br> | GE1013<br>12 / 16 mm<br> | asse fissaggio viti<br>fermavetro<br>Securing axis for screws<br>for the glazing beads | rientro fermavetro<br>Glazing beads gap | boccole e viti<br>fissaggio fermavetro<br>Bushing and screws for<br>glazing bead fixing | spessore per vetro<br>Glass shim |         |
| Code                       |                            | a                     | b                      | b                      | b                      | b                        | x  | c                                       | y   | α                                | β       |
| <br>PR2007                 | 38<br>-<br>54              | 3                     | 51                     | 50                     | 46                     | 38                       | 9.5  | 2                                       | CV5001(i)<br>CV5012(i)  | GU1311                           | GUM020* |
|                            |                            |                       | -                      | -                      | -                      | -                        |  |   |   |                                  |         |
| 53                         | 52                         |                       | 48                     | 40                     | 7.5                    | 0                        |  |   |   |                                  |         |
| -                          | -                          |                       | -                      | -                      |                        |                          |  |   |   |                                  |         |
| 54                         | 53                         |                       | 50                     | 44                     |                        |                          |  |   |   |                                  |         |
| <br>PR1007                 | 38<br>-<br>50              |                       | 47                     | 46                     | 42                     | 38 min                   | 13.5   | 2                                       | CV5001(i)<br>CV5012(i)  | GU1311                           | GUM020* |
|                            |                            | -                     | -                      | -                      | -                      | -                        |  |   |   |                                  |         |
| 48                         | 47                         | 44                    | 38 min                 | 11.5                   | 0                      |                          |  |   |   |                                  |         |
| -                          | -                          | -                     | -                      |                        |                        |                          |  |   |   |                                  |         |
| 49                         | 48                         | 44                    | 40                     |                        |                        |                          |  |   |   |                                  |         |
| 50                         | 49                         | 46                    |                        |                        |                        |                          |  |   |   |                                  |         |
| <br>PR2008                 | 39<br>-<br>45              | -                     | -                      | -                      | -                      | -                        | -  | CV5001(i)<br>CV5012(i)                  | GU1311  | GUM020*                          |         |
|                            |                            | 44                    | 43                     | 39                     | -                      |                          |  |   |   |                                  |         |
| -                          | -                          | -                     | -                      | 16                     | 0                      |                          |  |   |   |                                  |         |
| 45                         | 44                         | 41                    |                        |                        |                        |                          |  |   |   |                                  |         |

\* da adattare allo spessore vetro utilizzato

\* adapt to the glass thickness

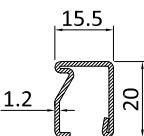
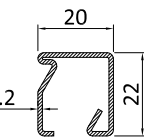
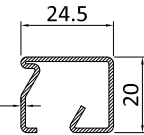

| F   | G                          | Guarnizioni - Gaskets   |   |   |   |   |  |   |  |                                  |         |
|---|----------------------------|---|---|---|---|---|--|---|--|----------------------------------|---------|
| fermavetro<br>Glazing bead  | range vetro<br>Glass range | GU2035<br>2 mm<br><br>+ sigillatura<br>+ Sealing | GP0095<br>2 / 3 mm<br> | GE1011<br>3 / 4 mm<br> | GE1012<br>6 / 8 mm<br> | GE1013<br>12 / 16 mm<br> | asse fissaggio viti<br>fermavetro<br>Securing axis for screws<br>for the glazing beads | rientro fermavetro<br>Glazing beads gap | boccole e viti<br>fissaggio fermavetro<br>Bushings and screws for<br>glazing bead fixing | spessore per vetro<br>Glass shim |         |
| Code  |                            | a   | b   | b   | b   | b   | x  | c                                       | y  | α                                | β       |
| <br>PR2007 | 39                         | 2   | 52  | 51  | 47  | 39  | 9.5  | 2                                       | CV5001(i)<br>CV5012(i)   | GU1311                           | GUM020* |
|   | -                          |   | 53  | 52  | 49  | 43  |  |   |  |                                  |         |
| 55  | 54                         |   | 53  | 49  | 41  | 7.5   | 0  |   |  |                                  |         |
| -   | 55                         |   | 54  | 51  | 45  |   |  |   |  |                                  |         |
| <br>PR1007 | 38                         |   | 48  | 47  | 43  | -   | 13.5   | 2                                       | CV5001(i)<br>CV5012(i)   | GU1311                           | GUM020* |
|   | -                          |   | 49  | 48  | 45  | -   |  |   |  |                                  |         |
| 51  | 50                         | 49  | 45  | 38 min  | 11.5  | 0   |  |   |  |                                  |         |
| -   | 51                         | 50  | 47  | 41  |   |   |  |   |  |                                  |         |
| <br>PR2008 | 40                         | -   | -   | -   | -   | -   | -  | CV5001(i)<br>CV5012(i)                  | GU1311   | GUM020*                          |         |
|   | -                          | 45  | 44  | 40  | -   |   |  |   |  |                                  |         |
| 46  | 46                         | 45  | 45  | 42  | 16  | 0   |  |   |  |                                  |         |

\* da adattare allo spessore vetro utilizzato

\* adapt to the glass thickness

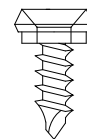
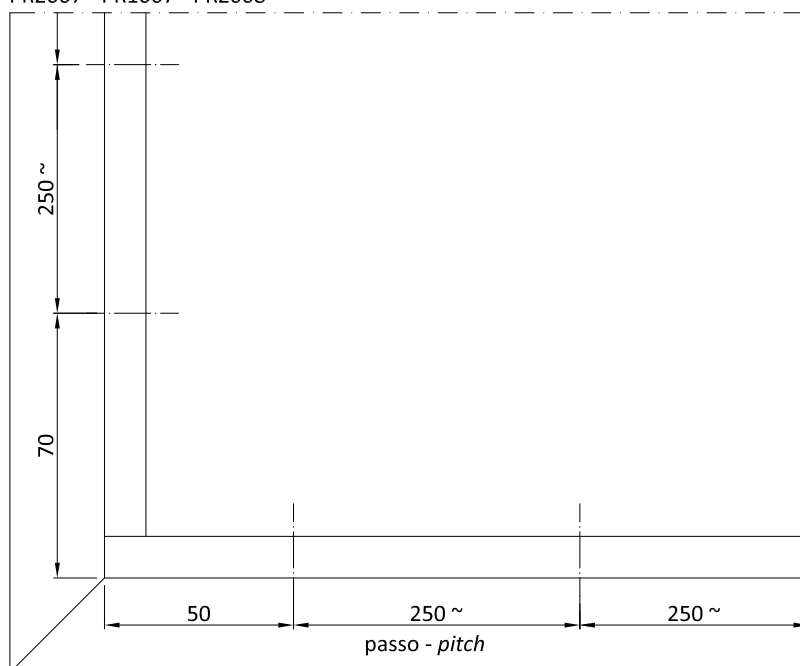

PR2007 - PR1007 - PR2008

CV5001 + CV5012  
CV5001I + CV5012IPasso vite e boccola fissaggio fermavetri  
*Clip pitch to fix glazing beads*Fori eseguibili con maschera AT1234  
Holes to be done with AT1234

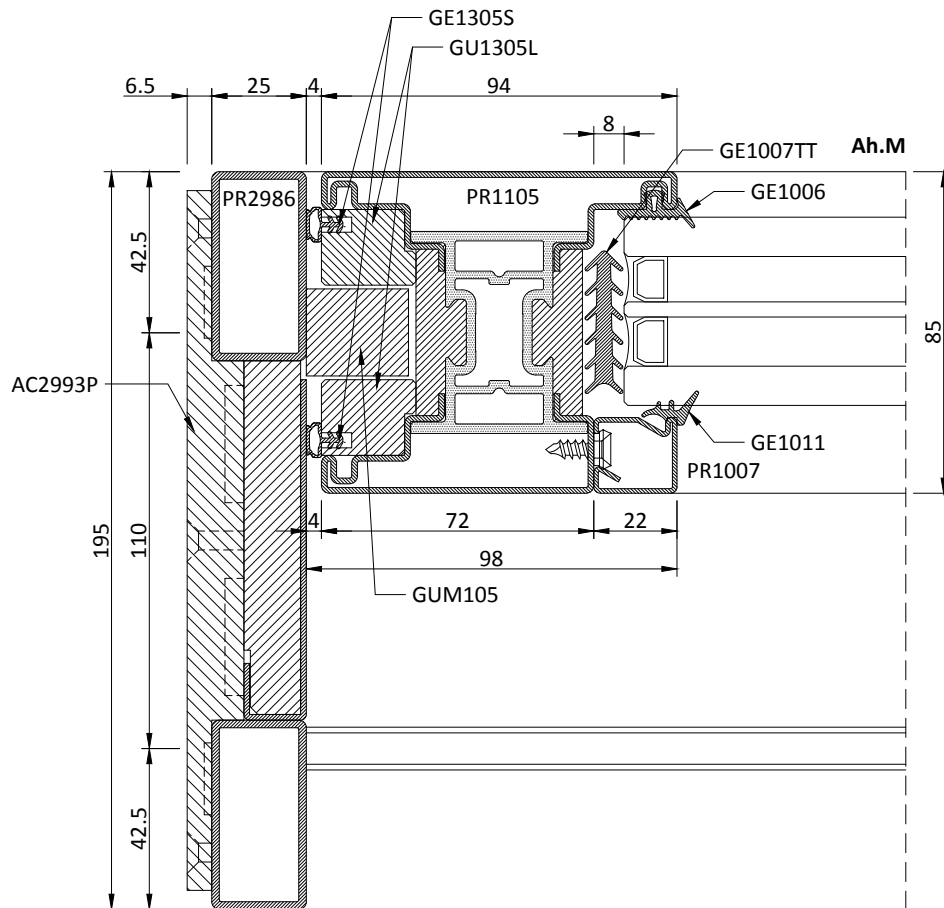
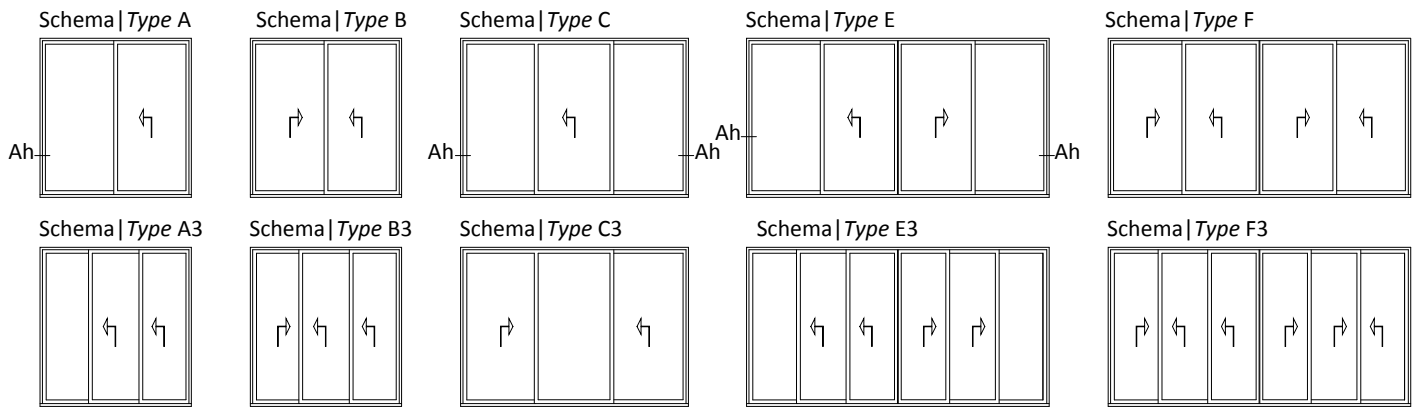

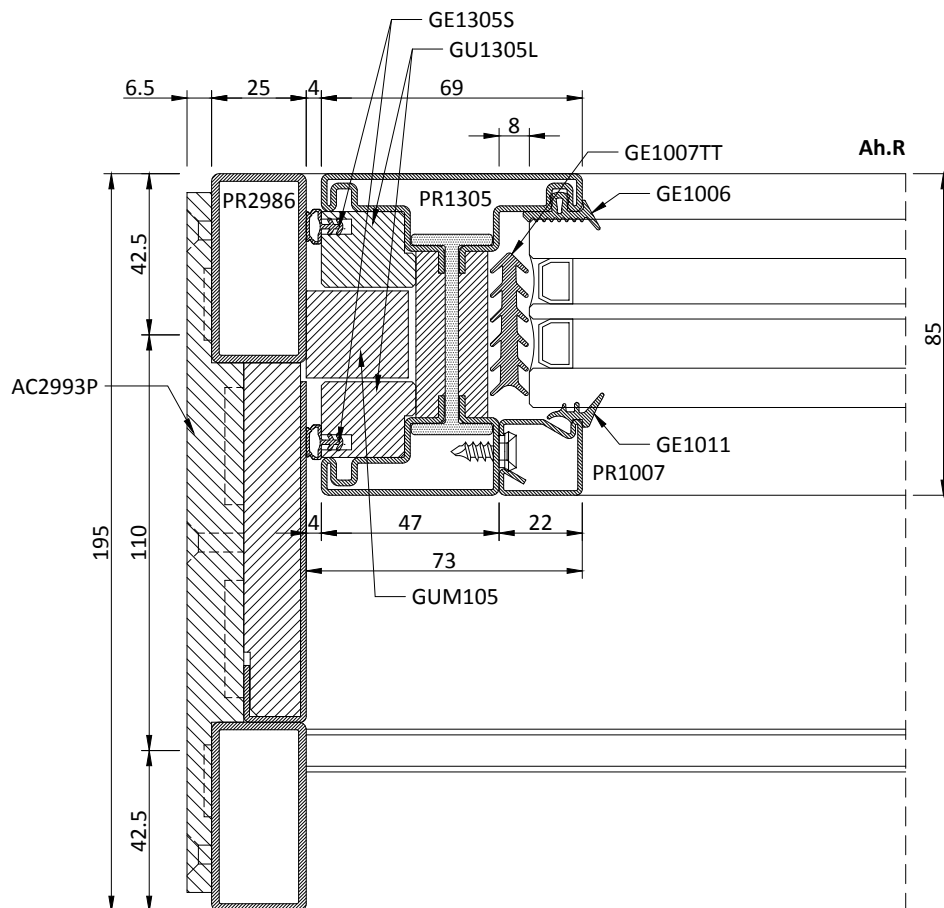
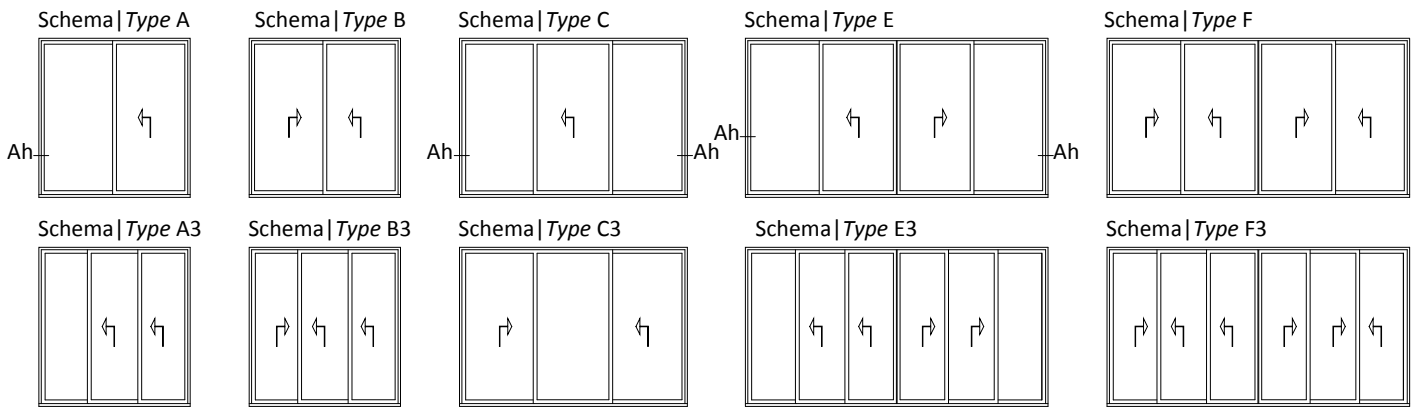

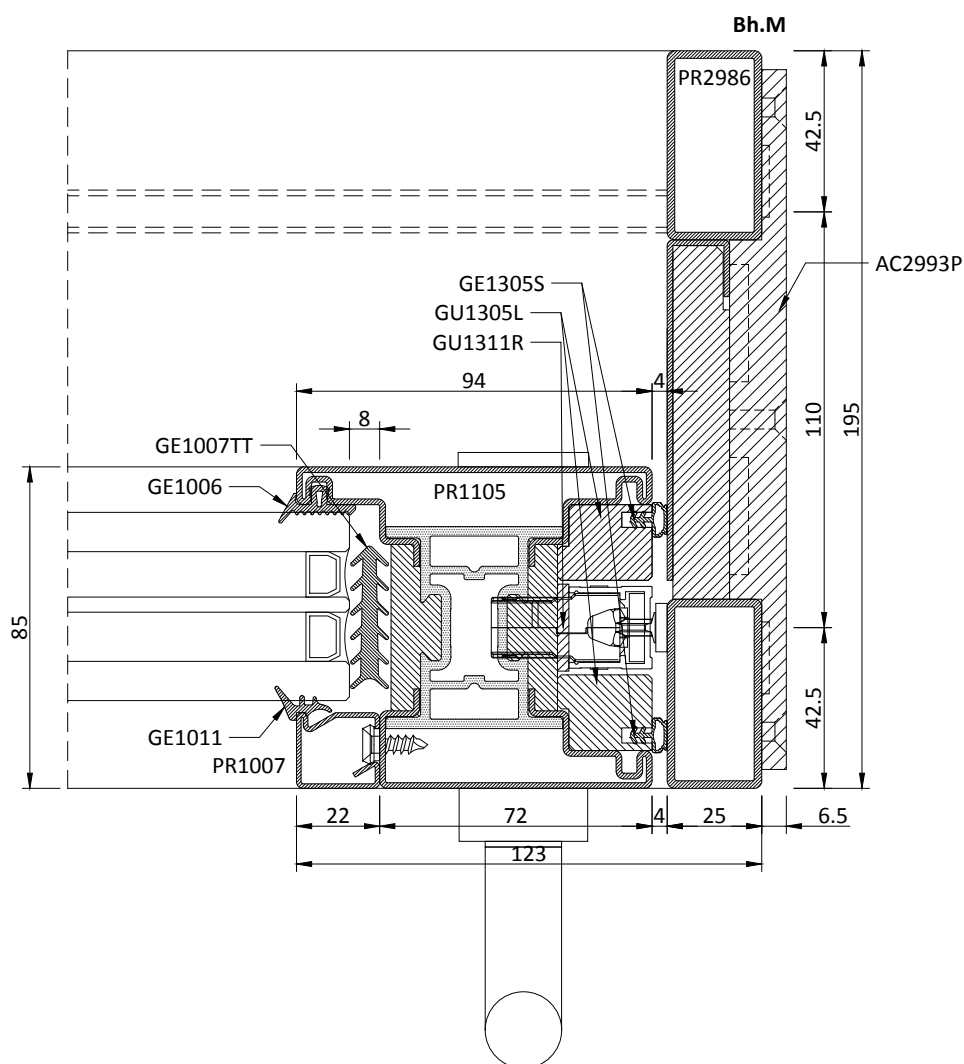
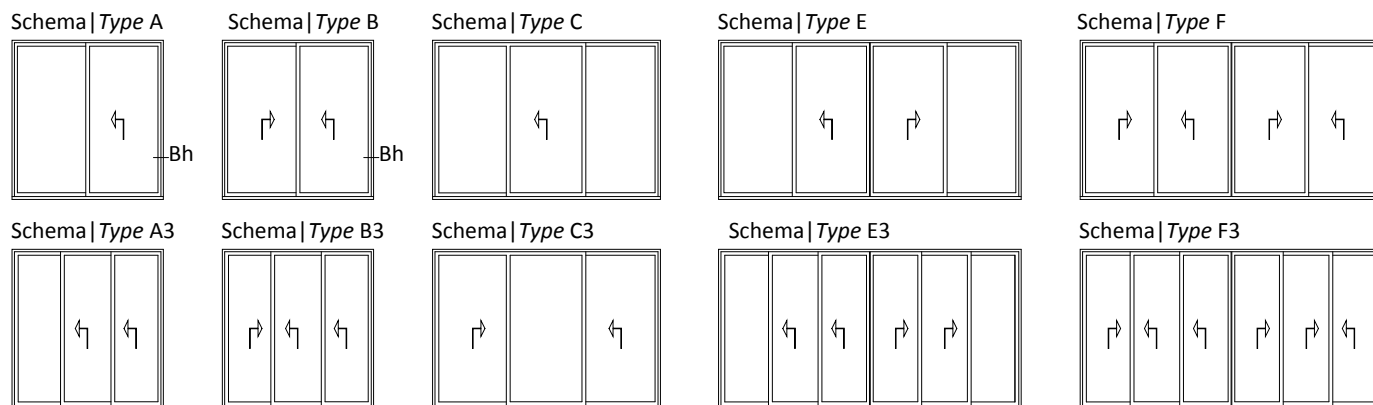

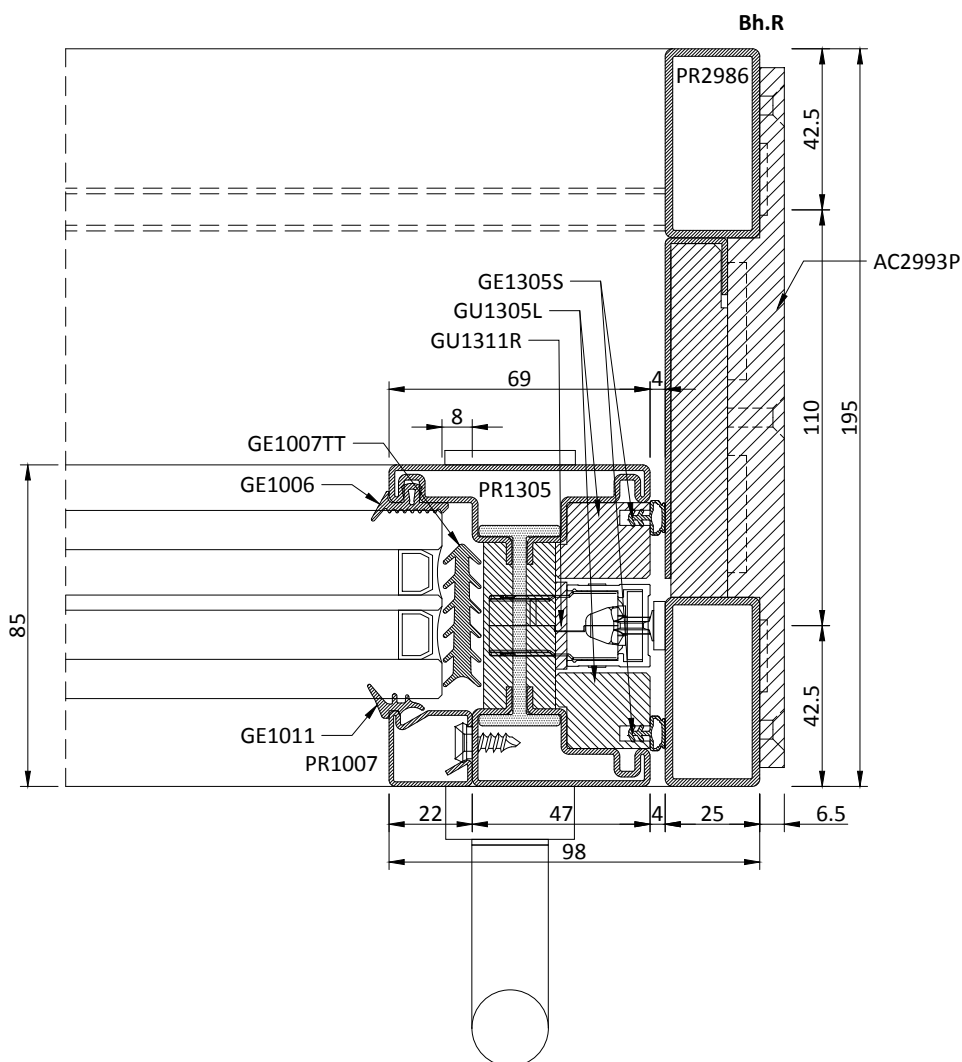
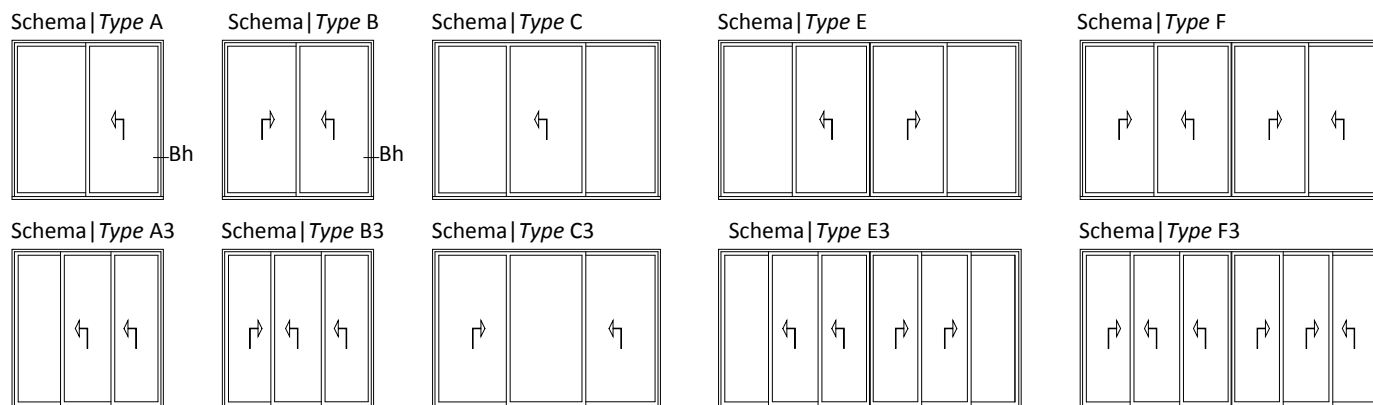

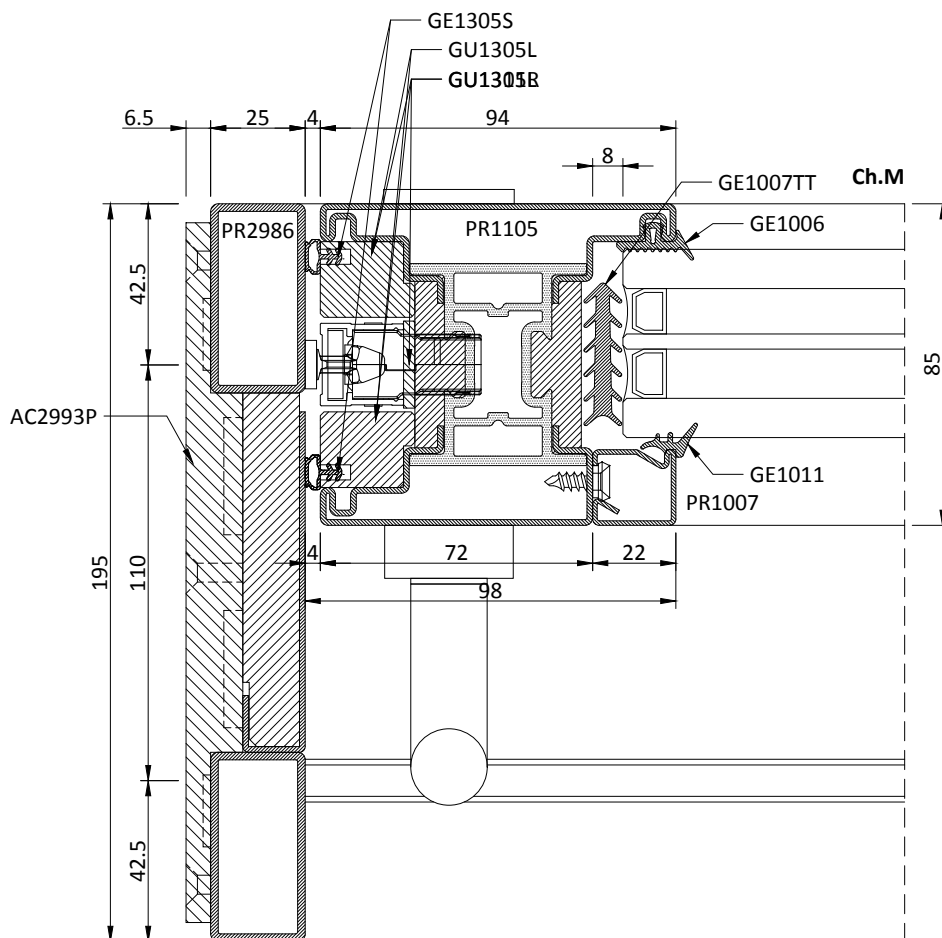
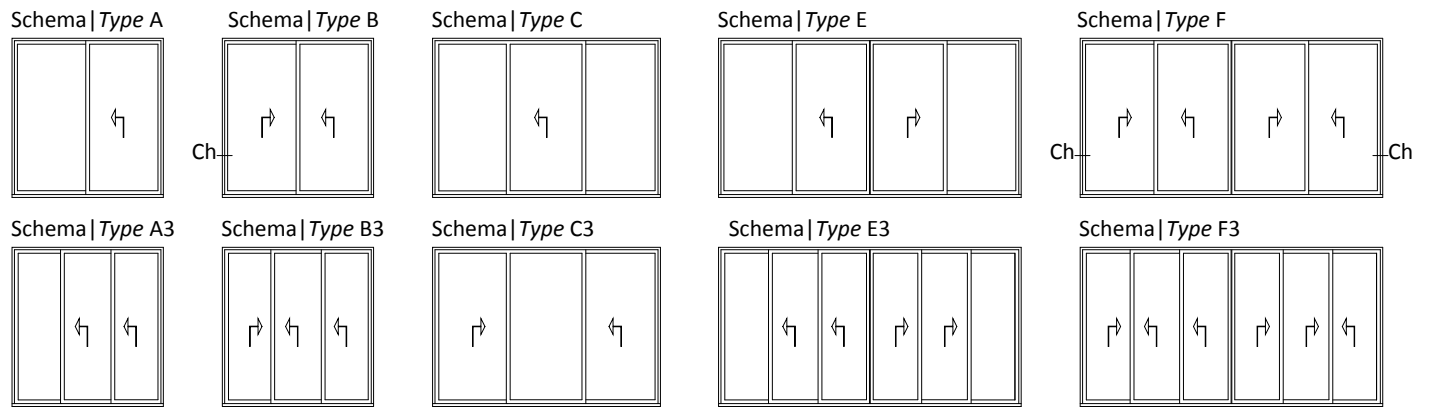

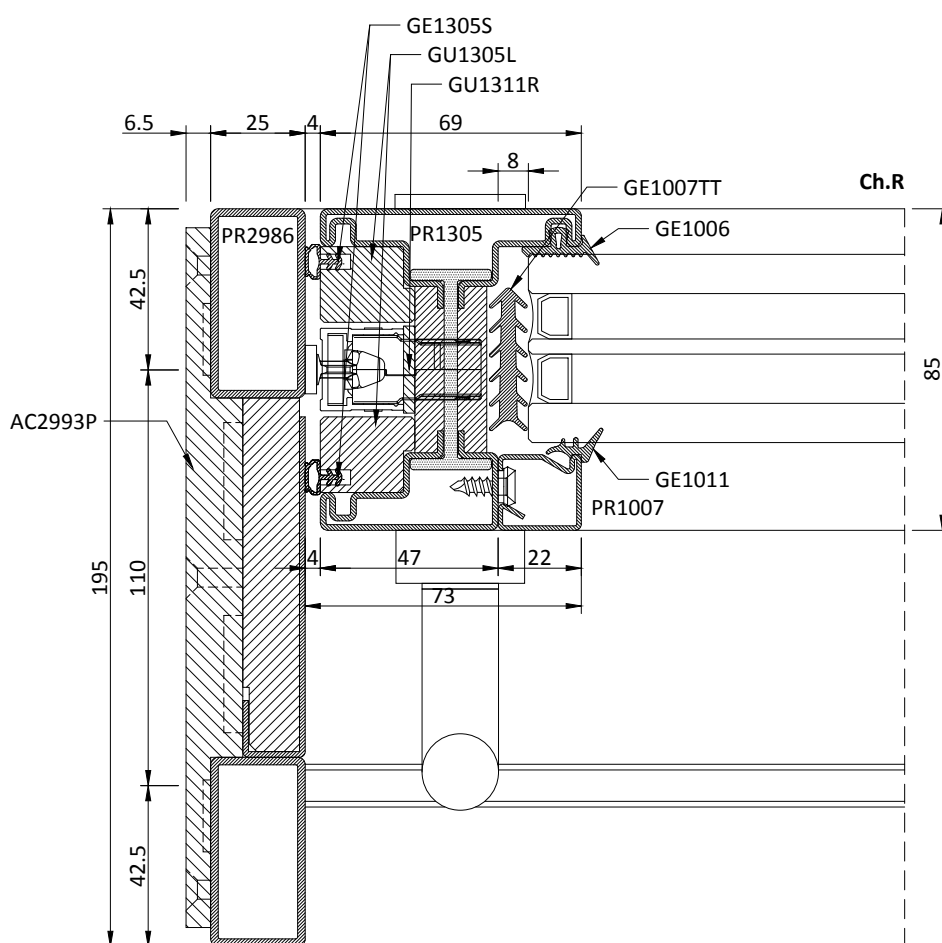
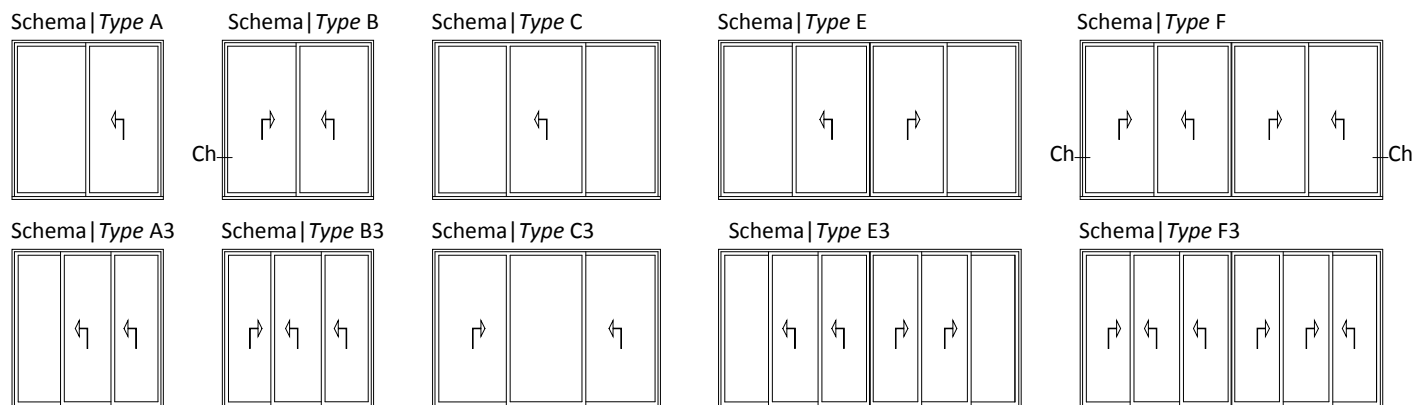

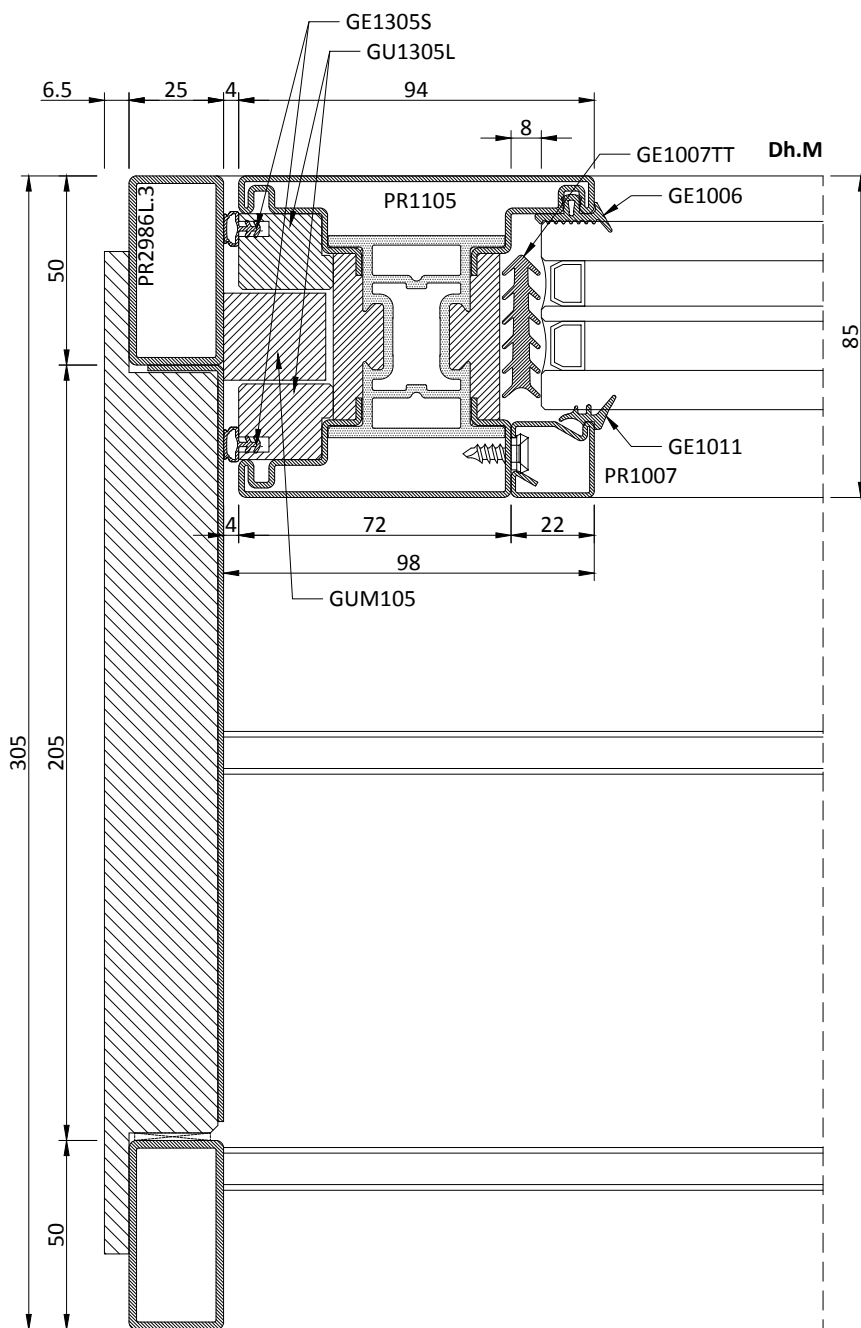
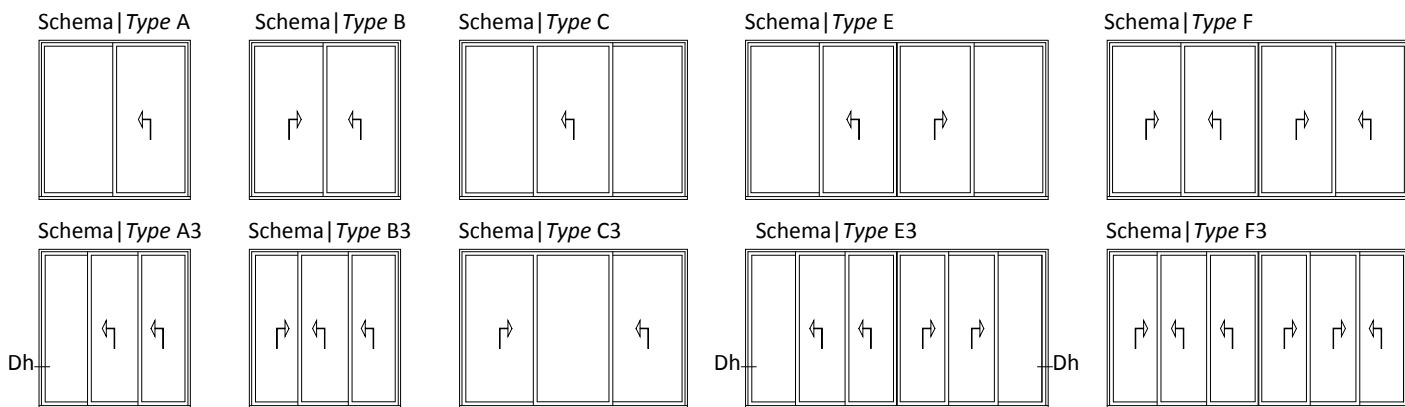



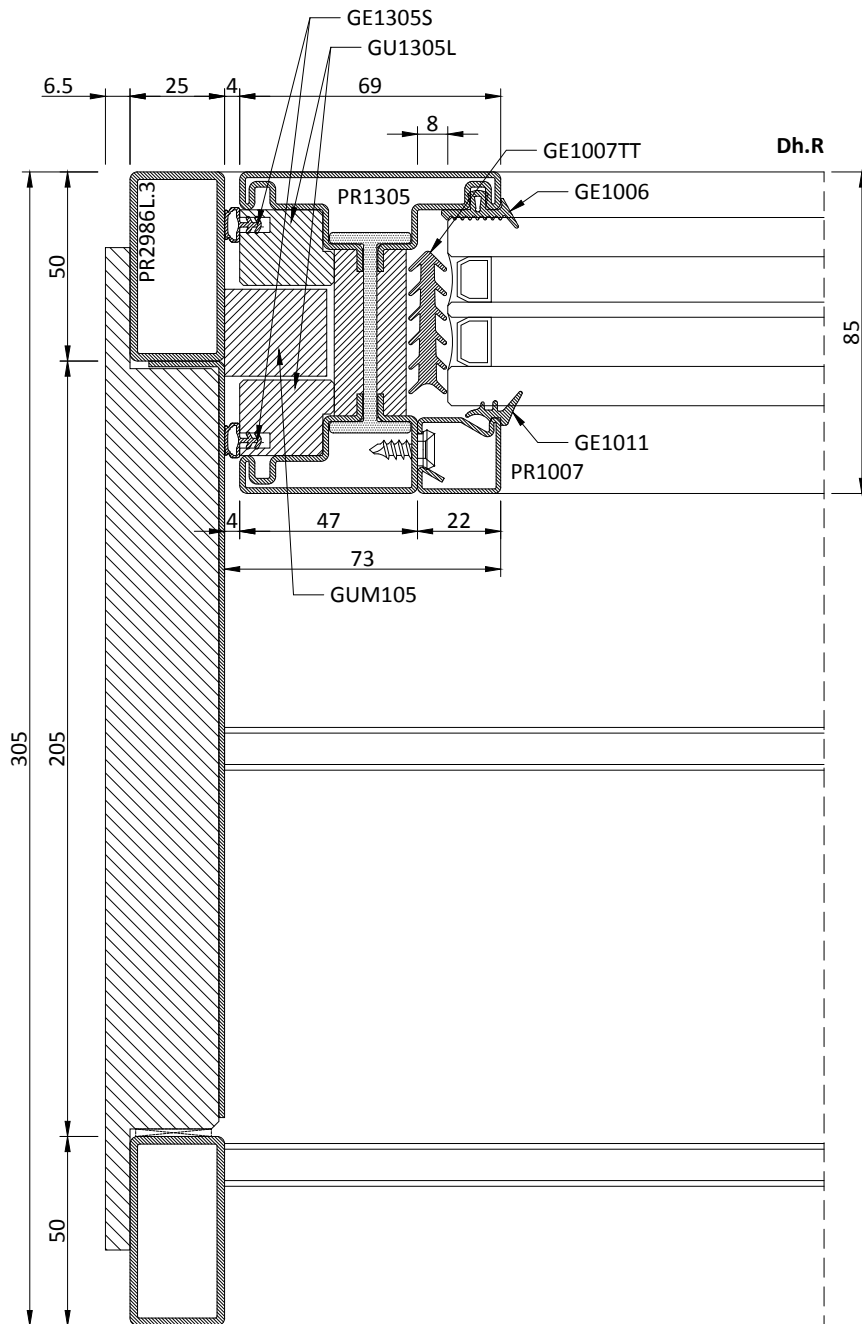
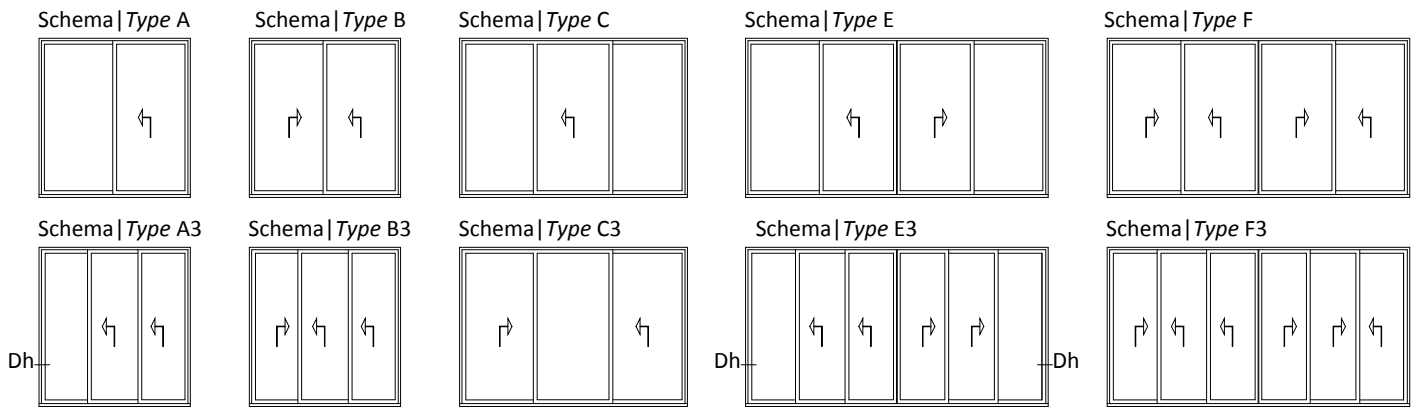

Schema | Type A

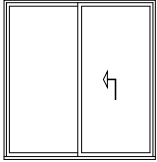

Schema | Type B

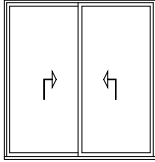

Schema | Type C

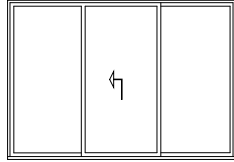

Schema | Type E

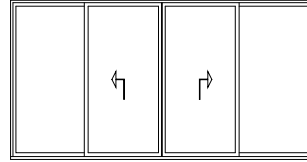

Schema | Type F

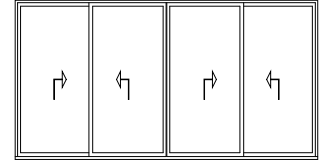

Schema | Type A3

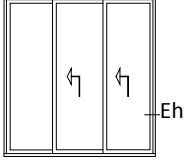

Schema | Type B3

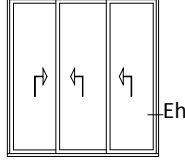

Schema | Type C3

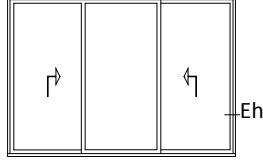

Schema | Type E3

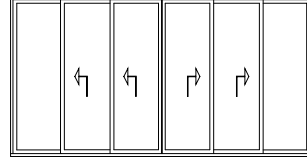

Schema | Type F3

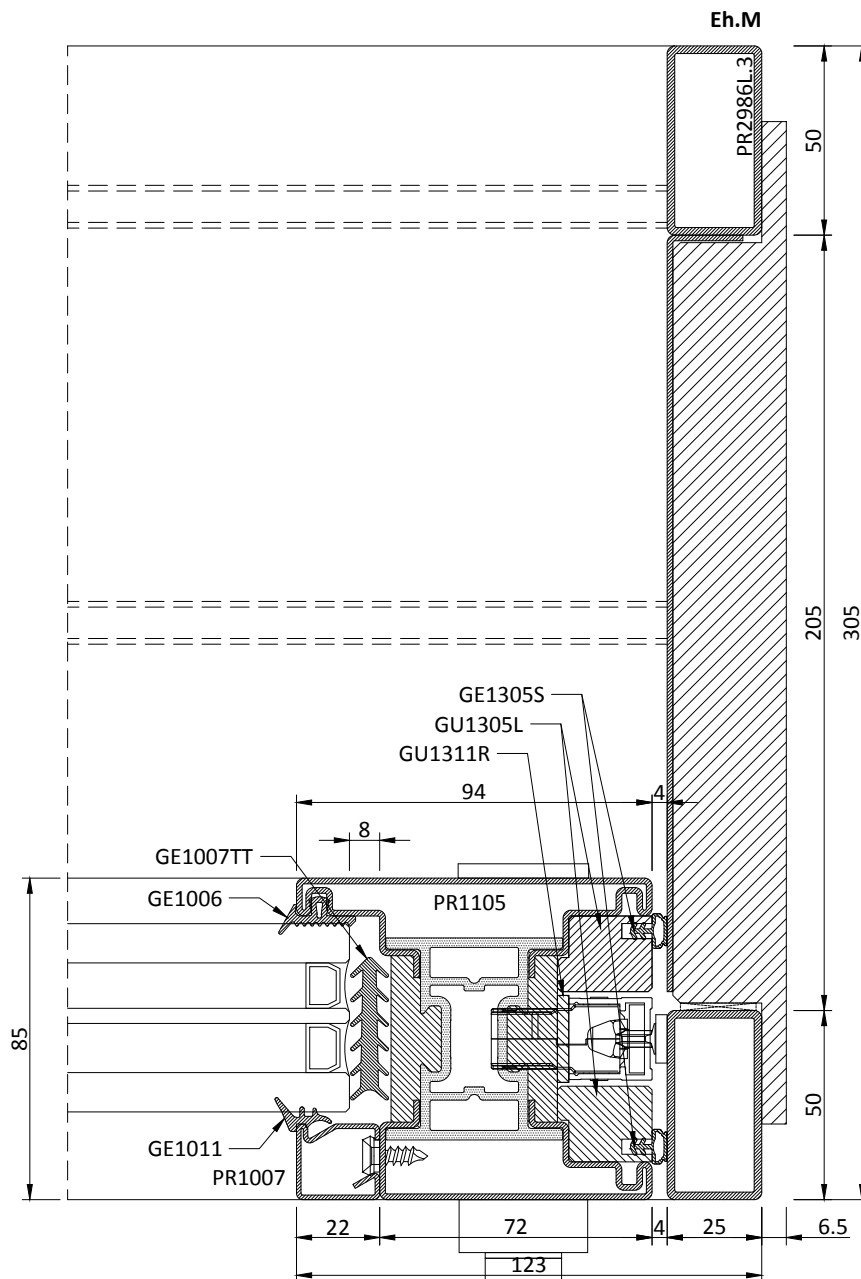
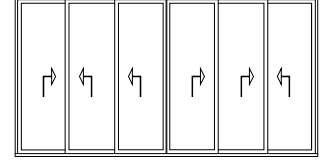

Schema | Type A

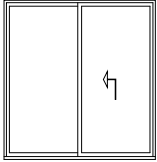

Schema | Type B

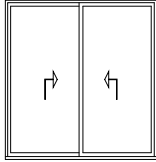

Schema | Type C

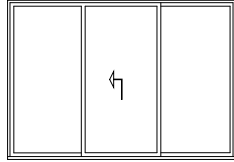

Schema | Type E

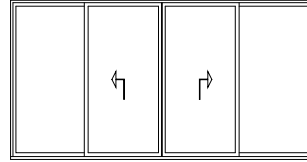

Schema | Type F

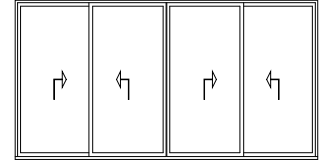

Schema | Type A3

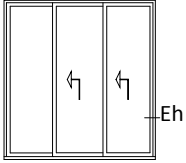

Schema | Type B3

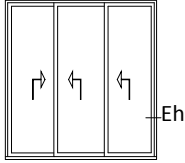

Schema | Type C3

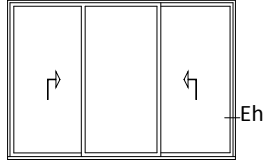

Schema | Type E3

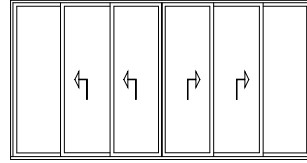

Schema | Type F3

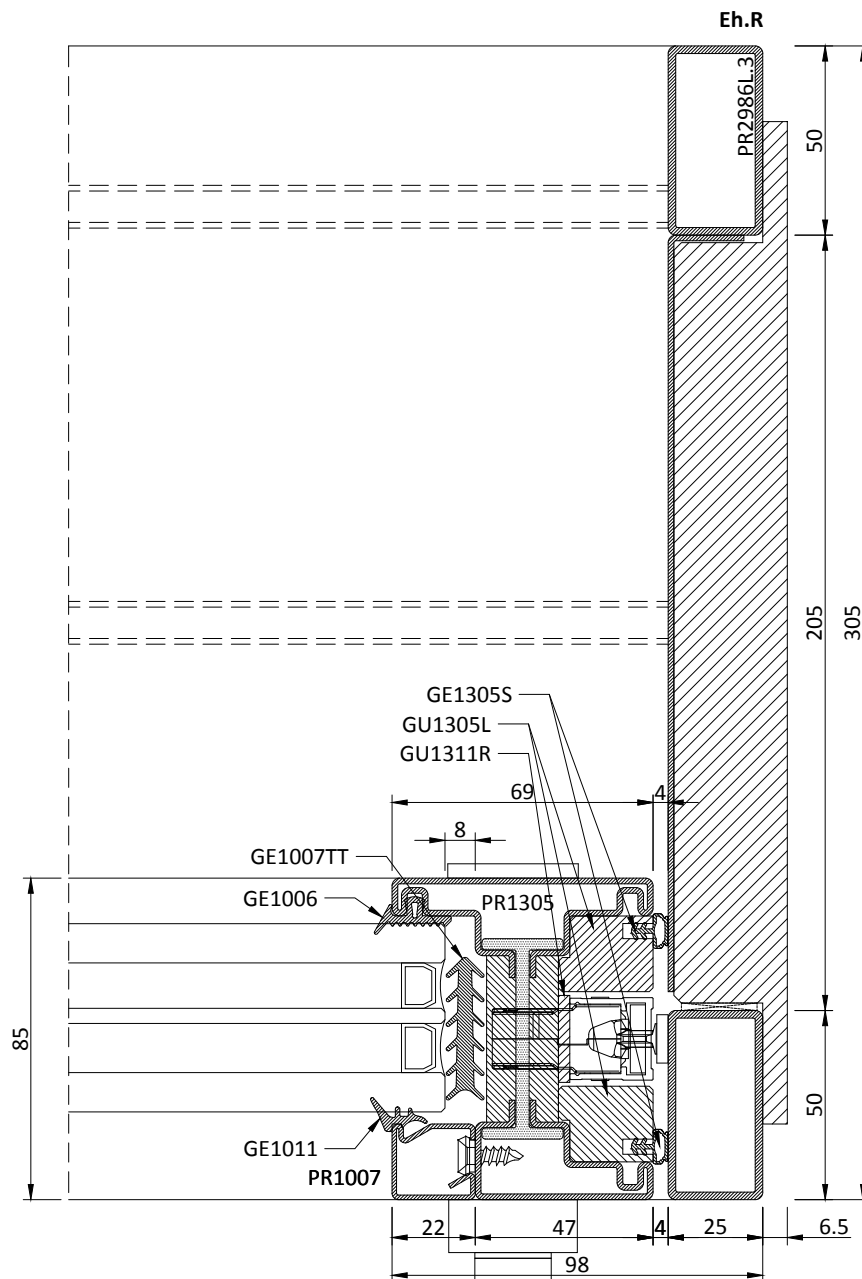
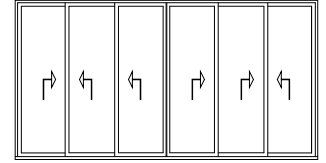

Schema | Type A

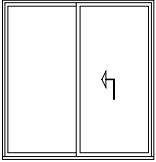

Schema | Type B

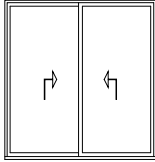

Schema | Type C

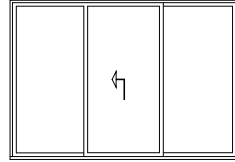

Schema | Type E

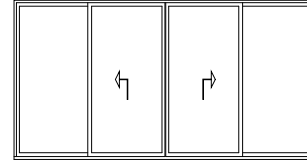

Schema | Type F

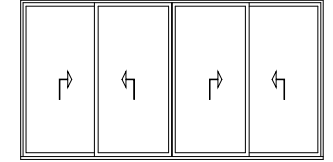

Schema | Type A3

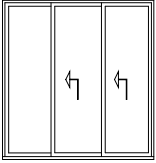

Schema | Type B3

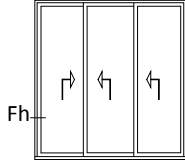

Schema | Type C3

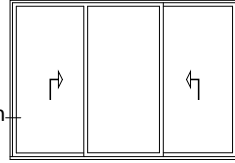

Schema | Type E3

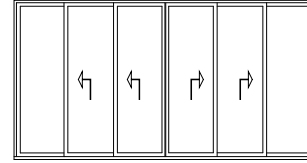

Schema | Type F3

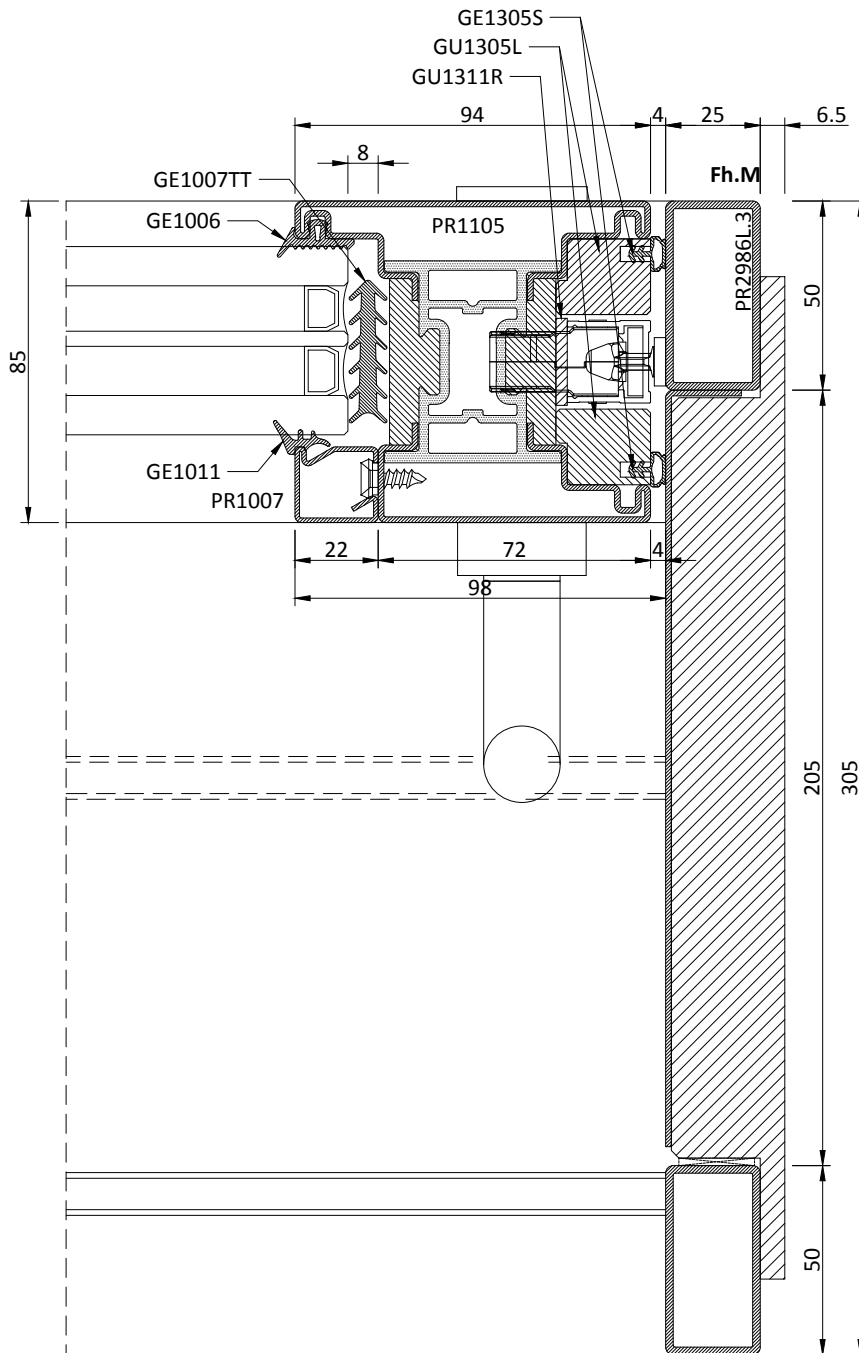
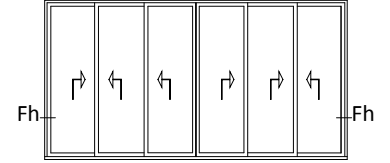

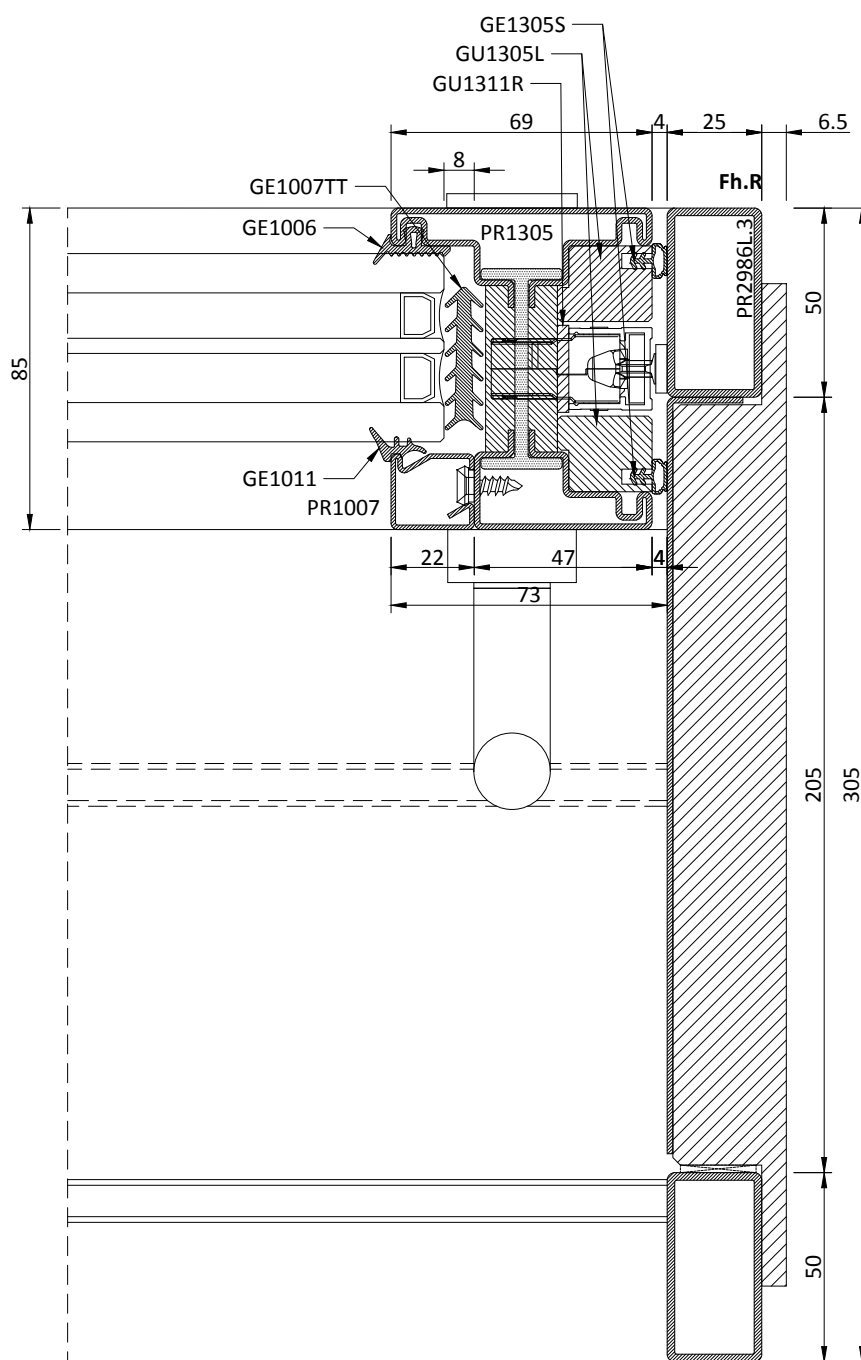
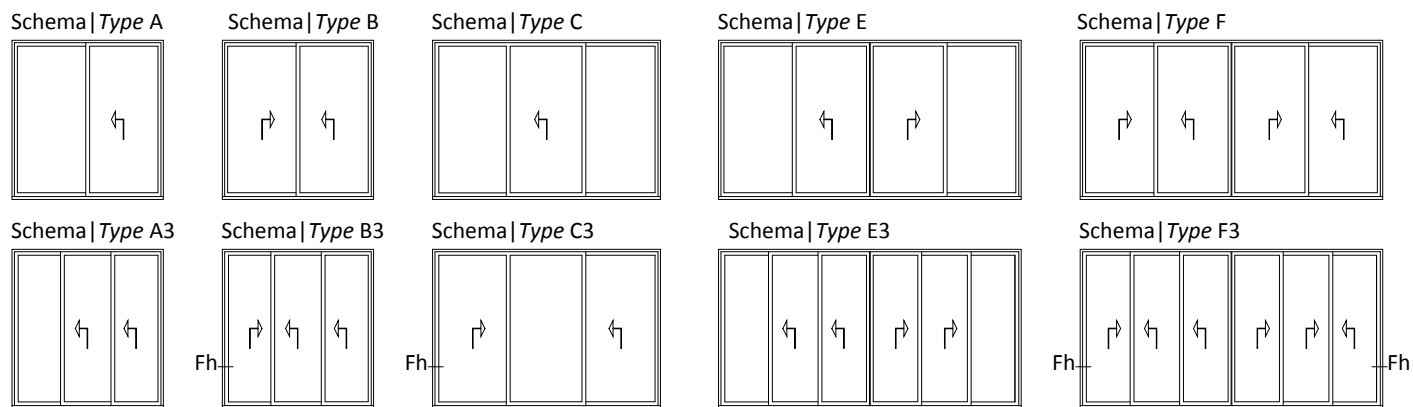

Schema | Type A

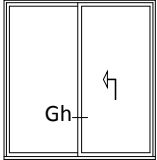

Schema | Type B

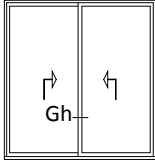

Schema | Type C

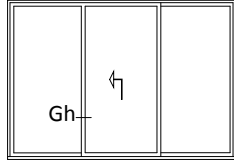

Schema | Type E

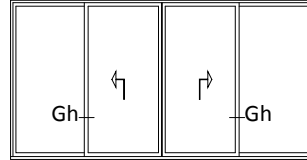

Schema | Type F

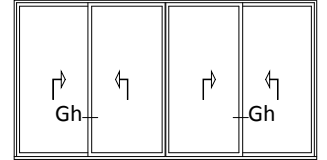

Schema | Type A3

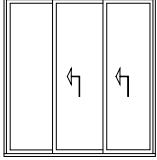

Schema | Type B3

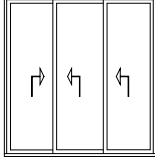

Schema | Type C3

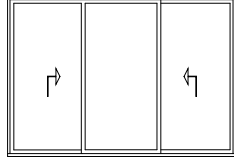

Schema | Type E3

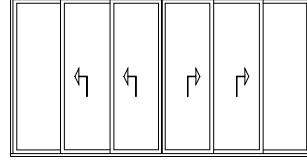

Schema | Type F3

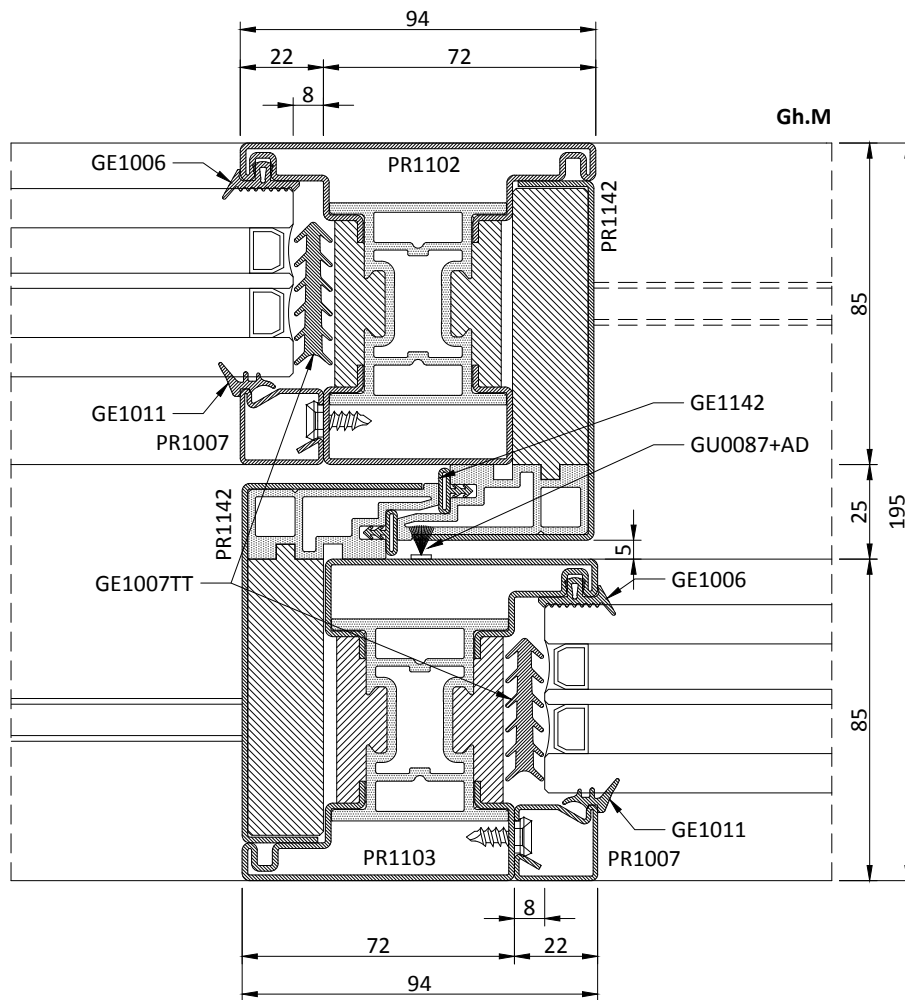
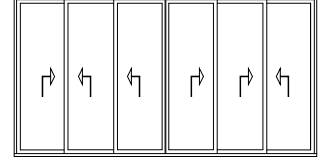

Schema | Type A

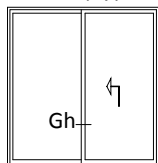

Schema | Type B

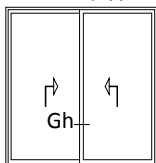

Schema | Type C

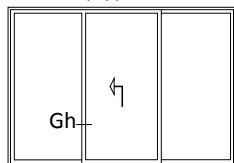

Schema | Type E

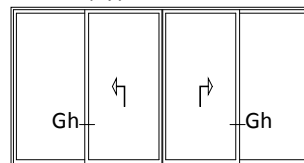

Schema | Type F

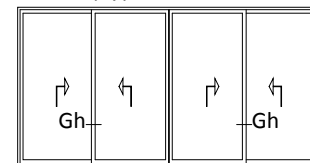

Schema | Type A3

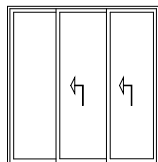

Schema | Type B3

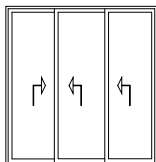

Schema | Type C3

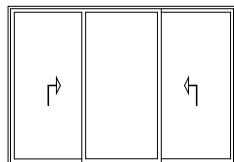

Schema | Type E3

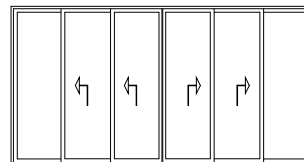

Schema | Type F3

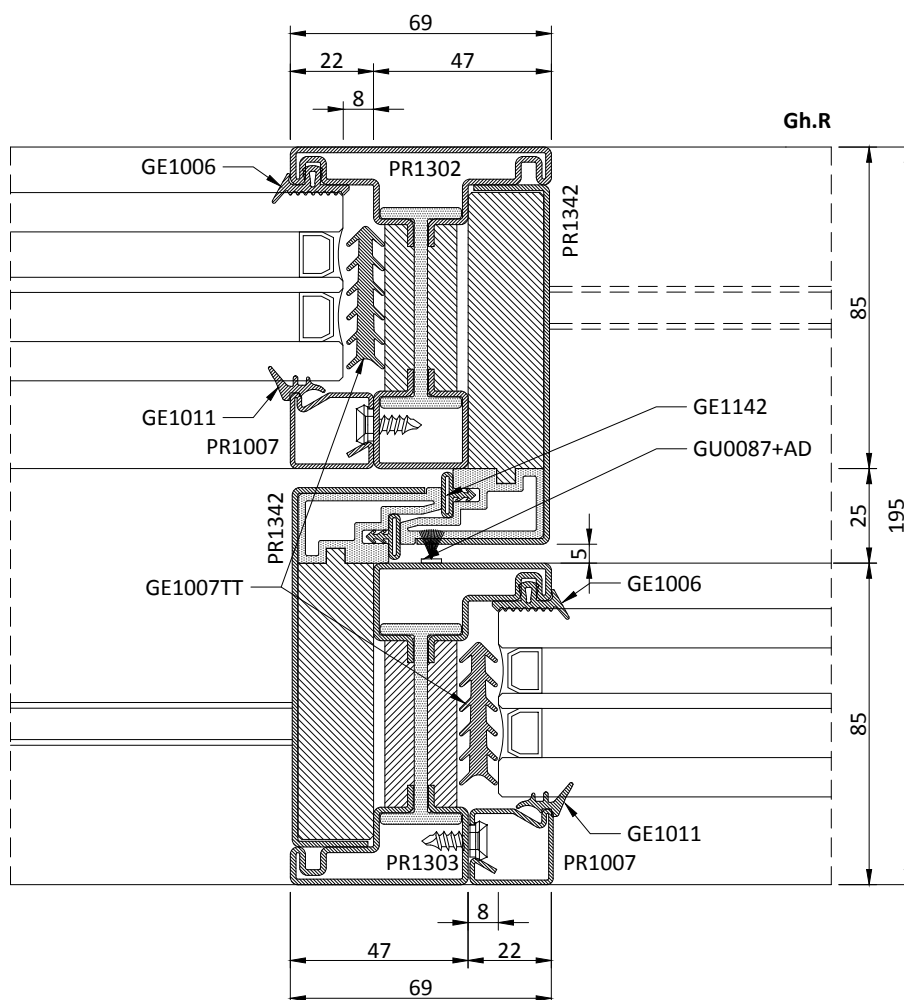
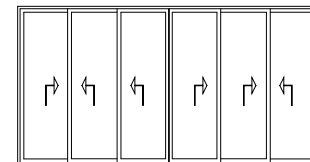

Schema | Type A

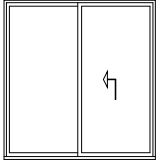

Schema | Type B

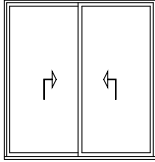

Schema | Type C

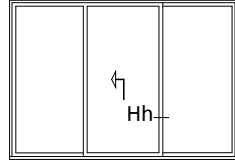

Schema | Type E

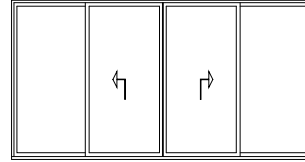

Schema | Type F

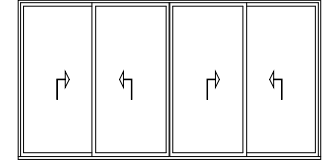

Schema | Type A3

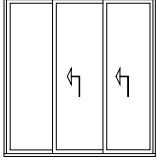

Schema | Type B3

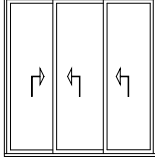

Schema | Type C3

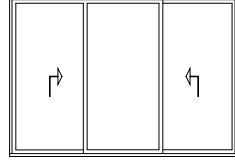

Schema | Type E3

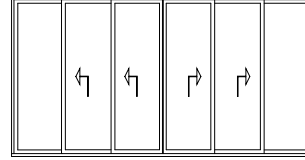

Schema | Type F3

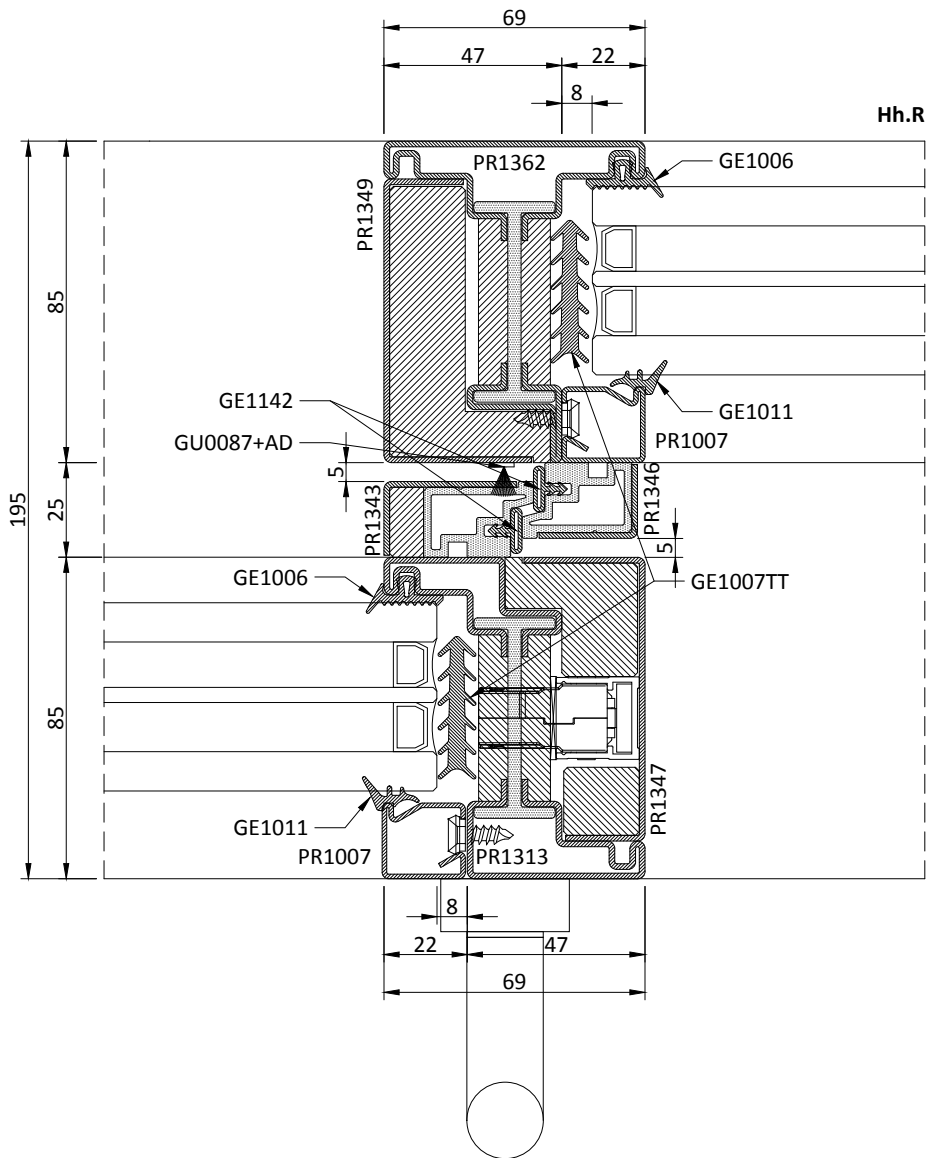
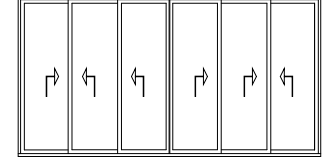



Schema | Type A

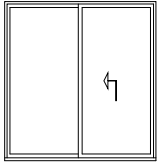

Schema | Type B

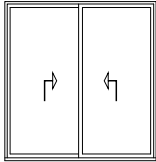

Schema | Type C

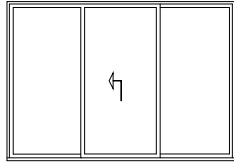

Schema | Type E

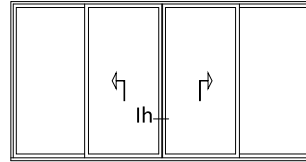

Schema | Type F

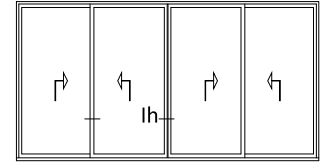

Schema | Type A3

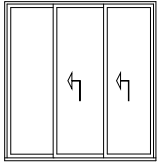

Schema | Type B3

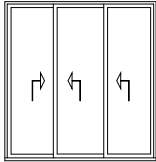

Schema | Type C3

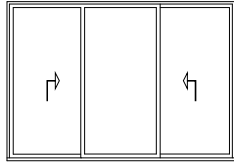

Schema | Type E3

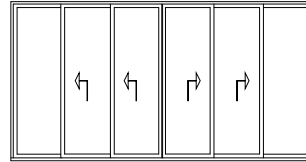

Schema | Type F3

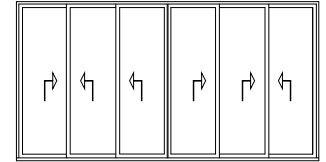

Ih.M

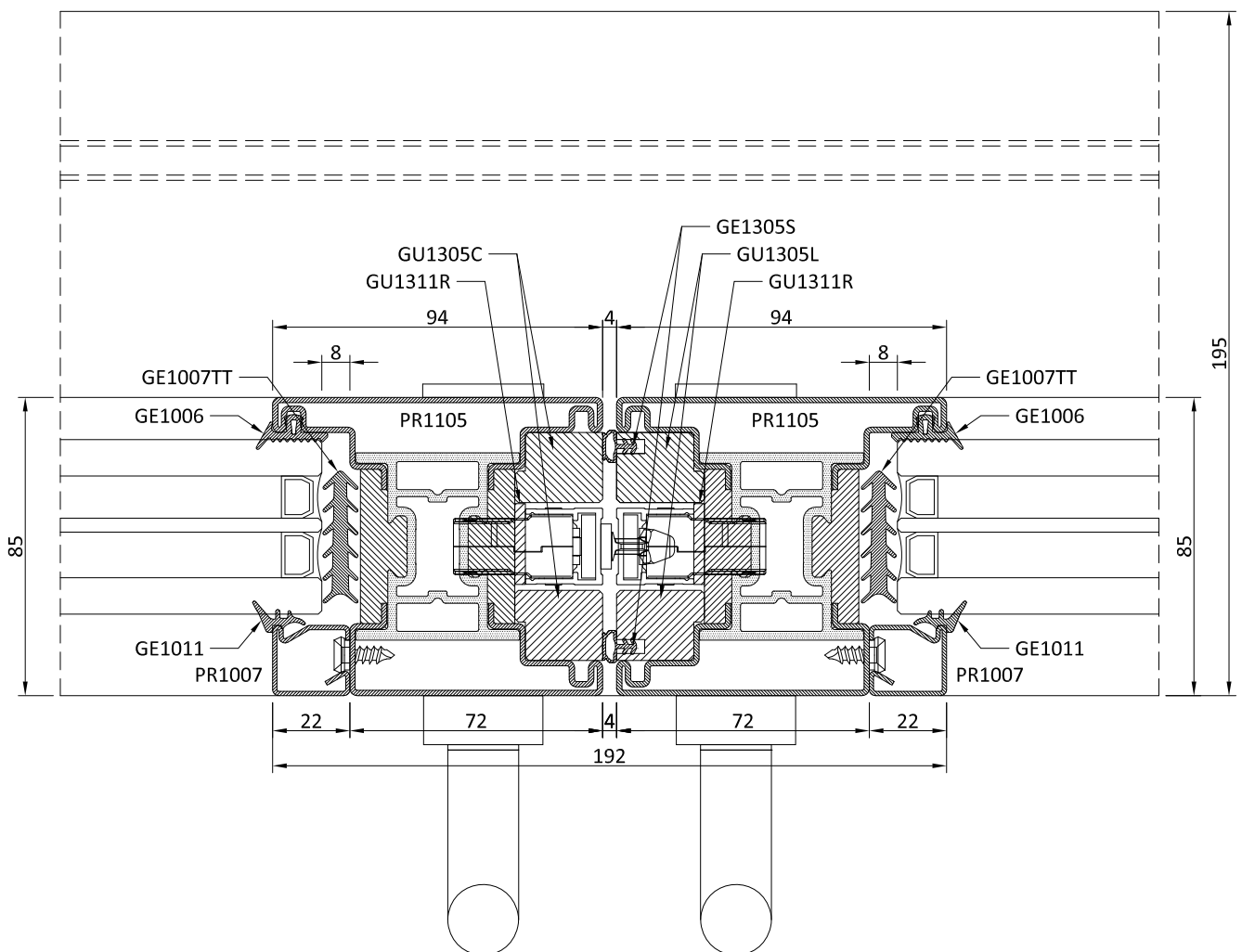

Schema | Type A

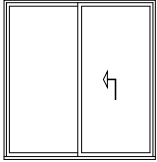

Schema | Type B

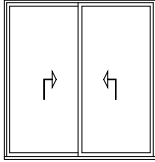

Schema | Type C

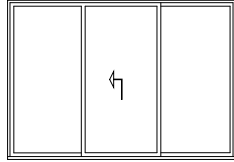

Schema | Type E

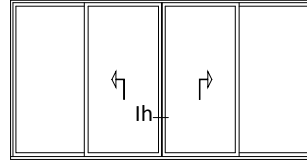

Schema | Type F

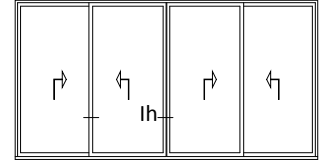

Schema | Type A3

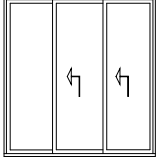

Schema | Type B3

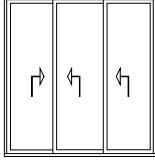

Schema | Type C3

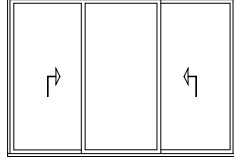

Schema | Type E3

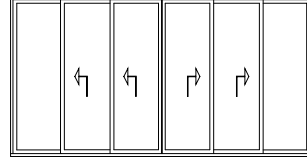

Schema | Type F3

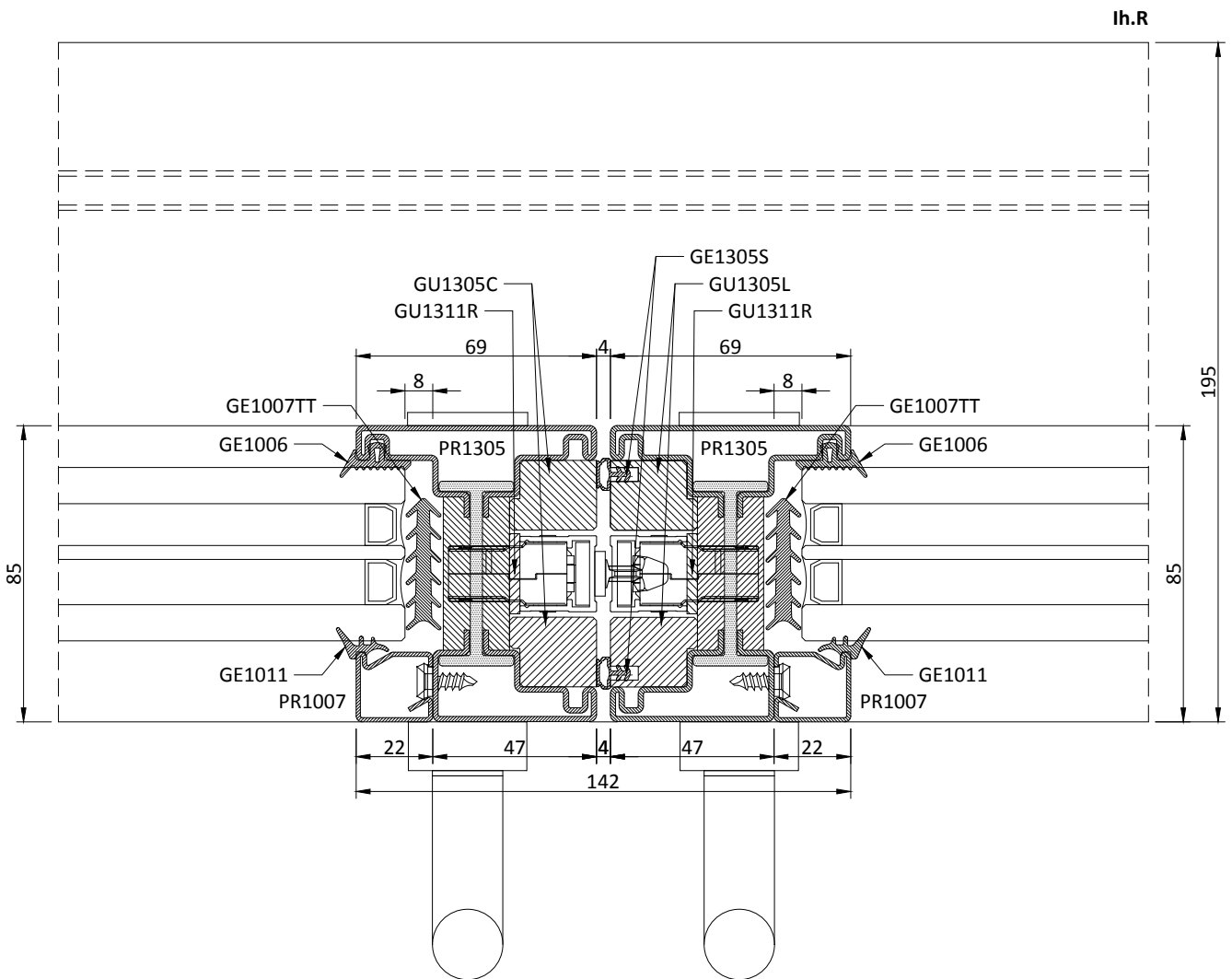
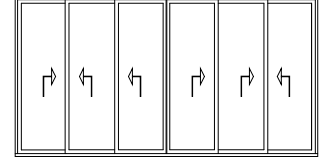

Schema | Type A

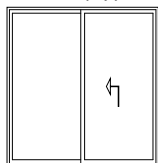

Schema | Type B

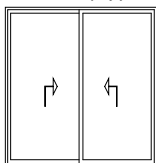

Schema | Type C

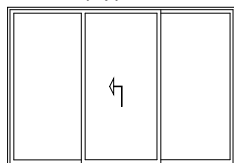

Schema | Type E

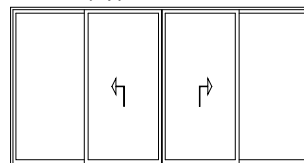

Schema | Type F

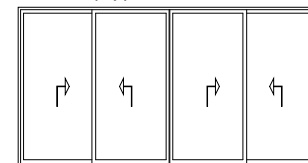

Schema | Type A3

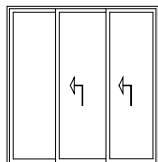

Schema | Type B3

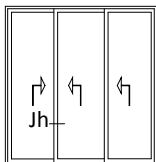

Schema | Type C3

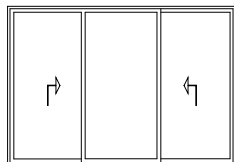

Schema | Type E3

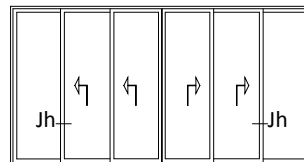

Schema | Type F3

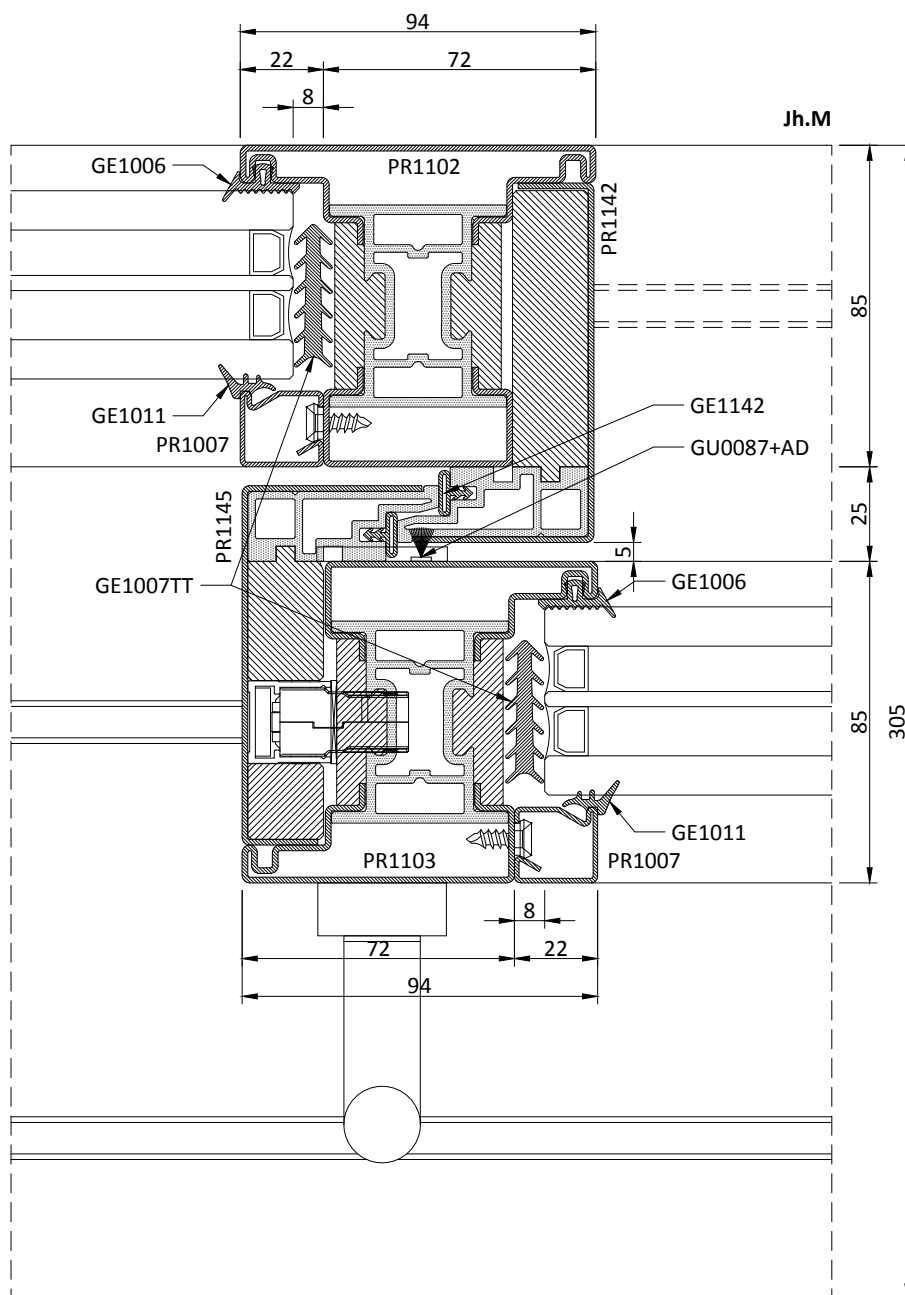
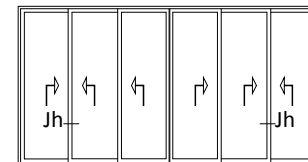

Schema | Type A

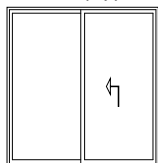

Schema | Type B

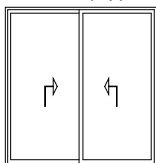

Schema | Type C

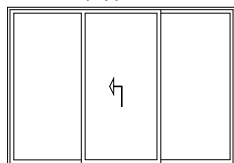

Schema | Type E

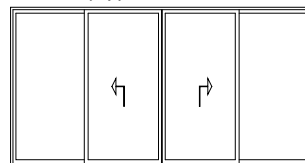

Schema | Type F

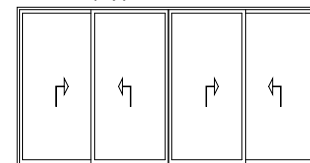

Schema | Type A3

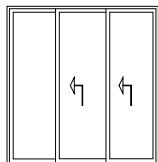

Schema | Type B3

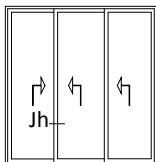

Schema | Type C3

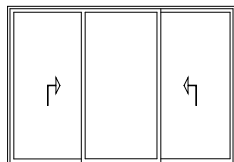

Schema | Type E3

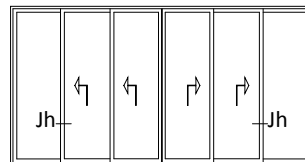

Schema | Type F3

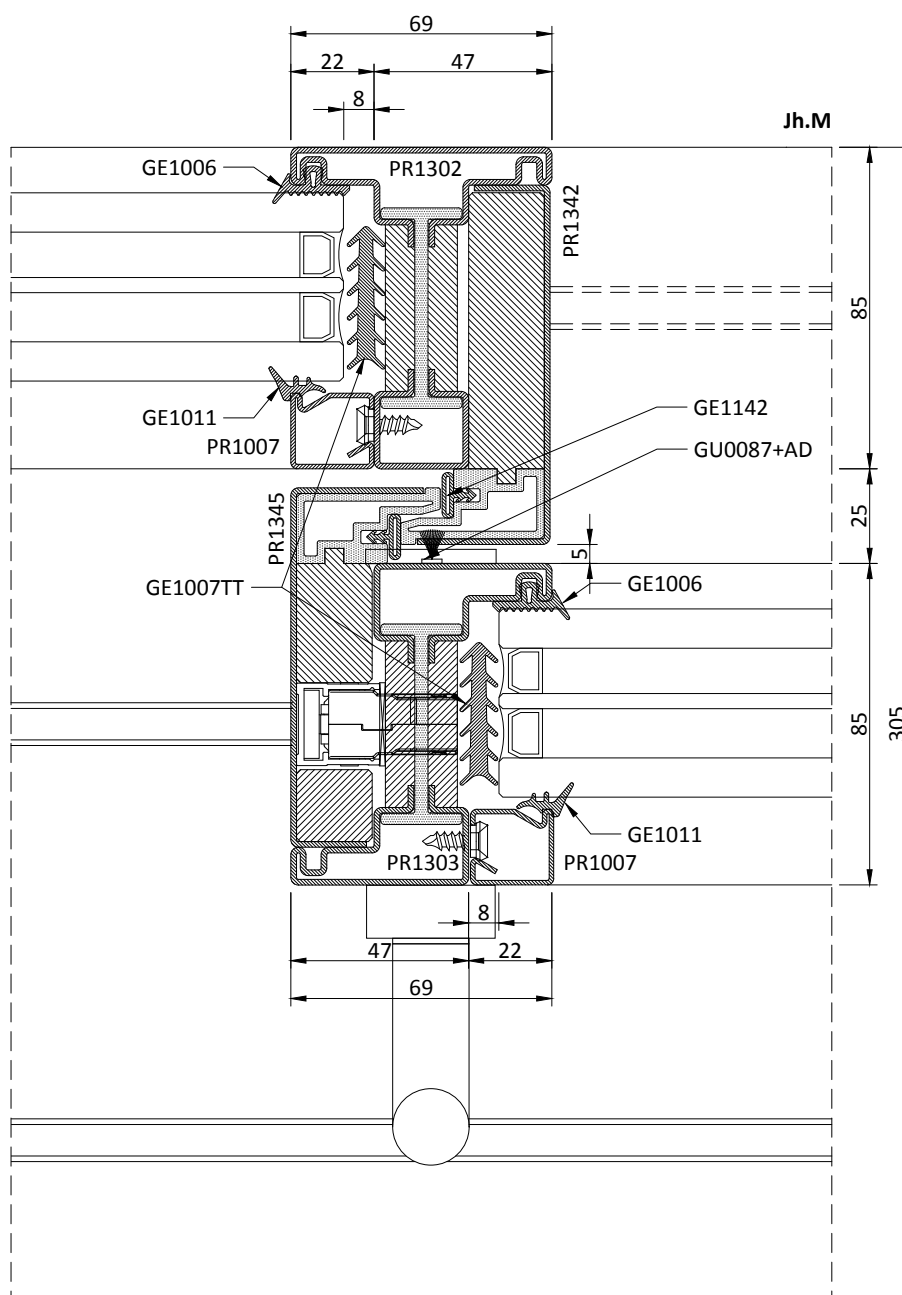
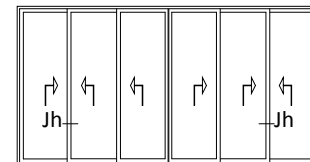

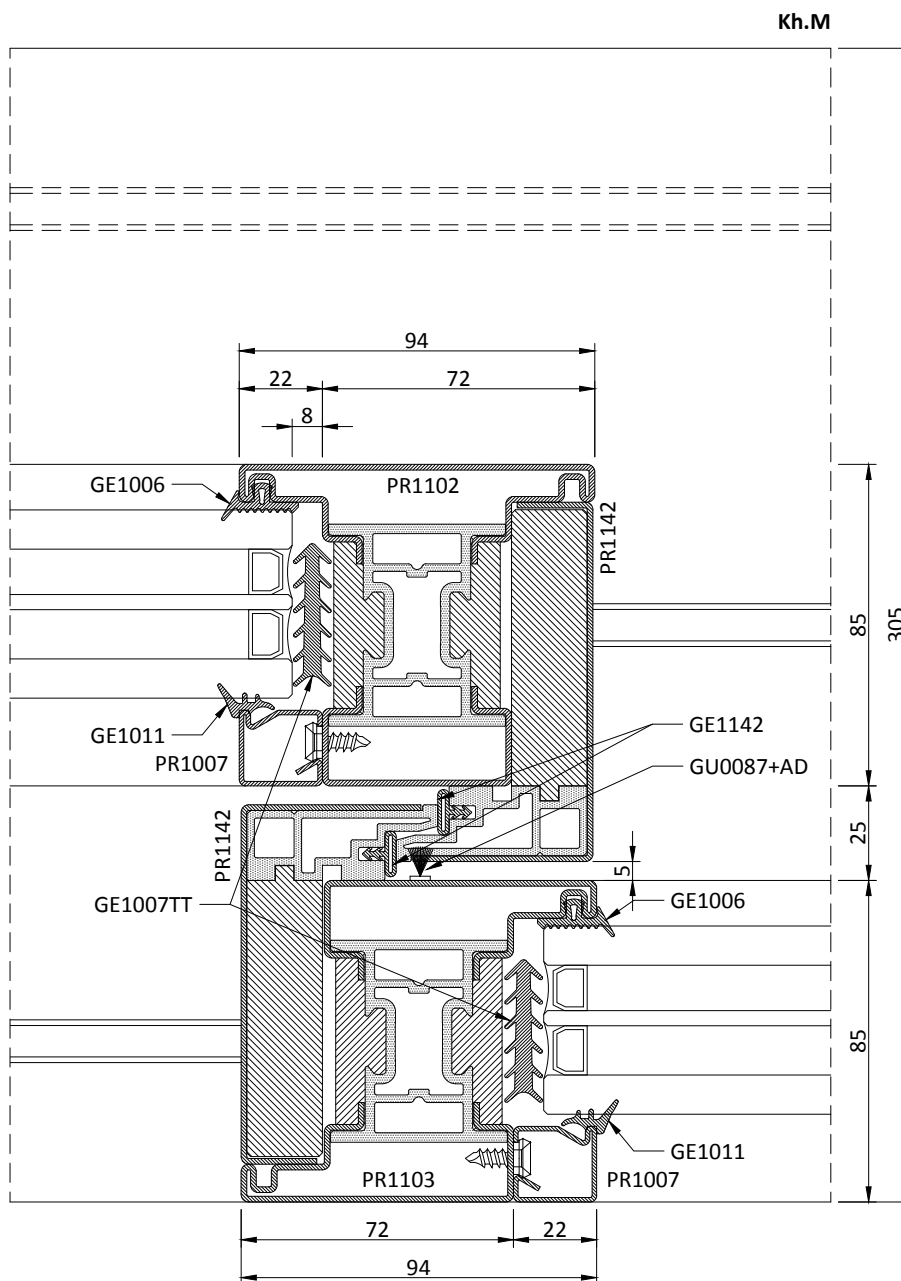
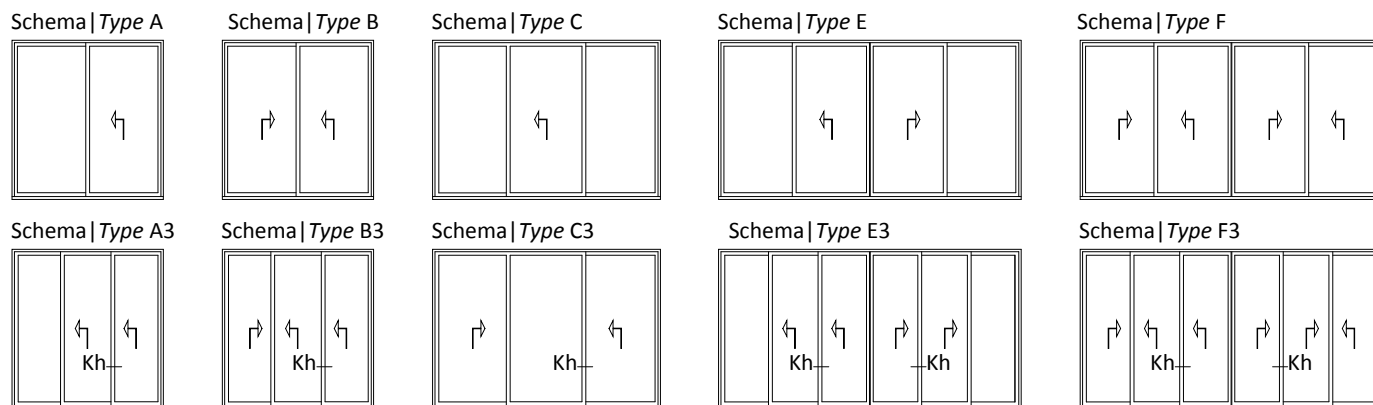

Schema | Type A

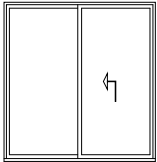

Schema | Type B

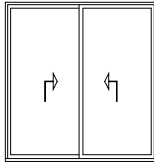

Schema | Type C

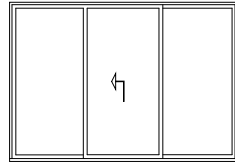

Schema | Type E

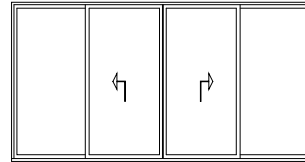

Schema | Type F

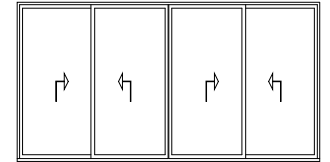

Schema | Type A3

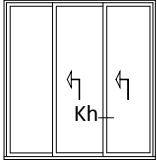

Schema | Type B3

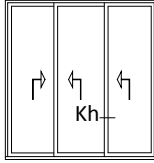

Schema | Type C3

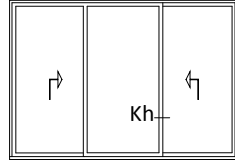

Schema | Type E3

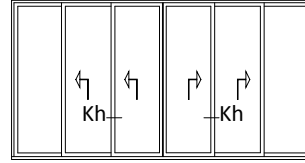

Schema | Type F3

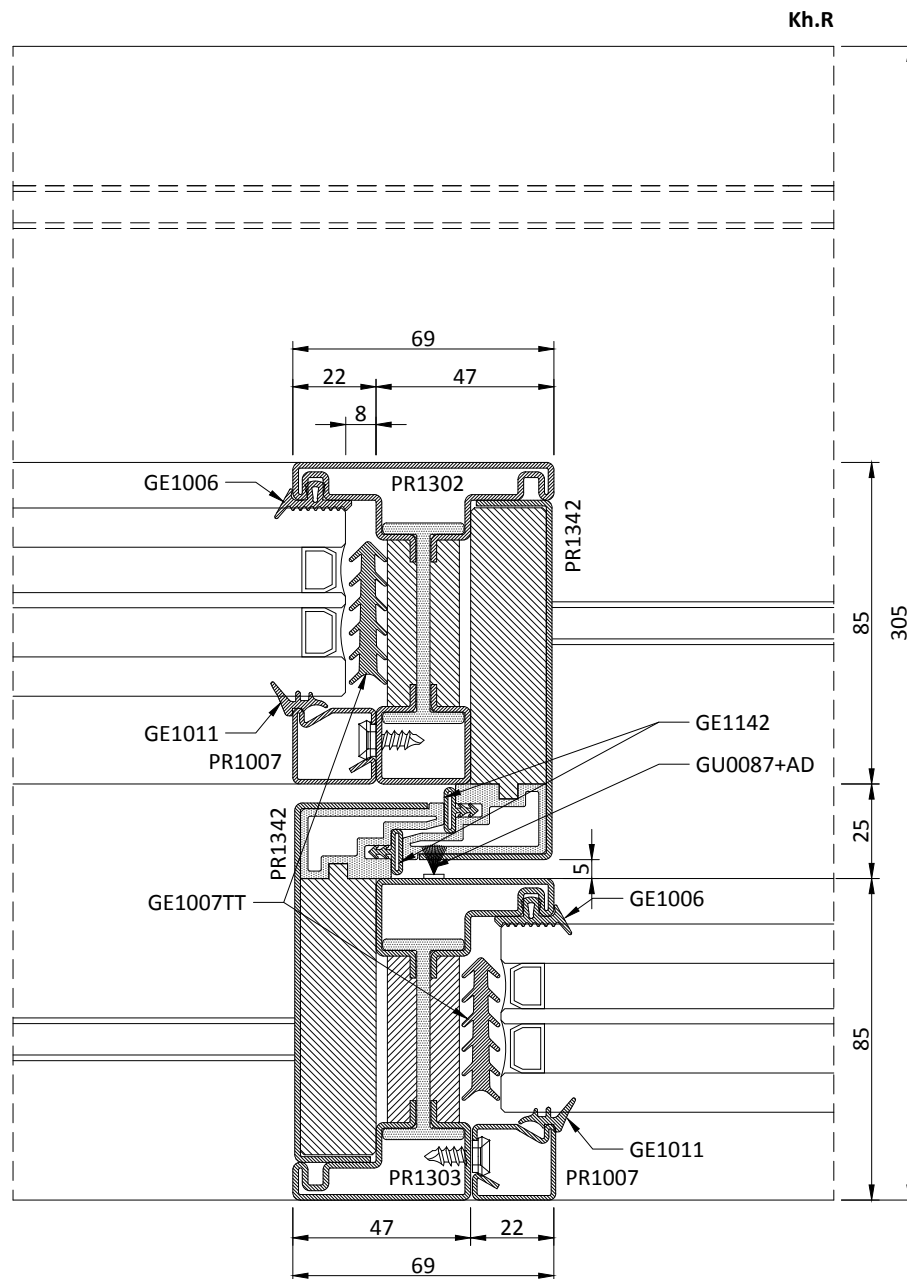
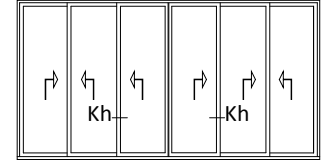

Schema | Type A

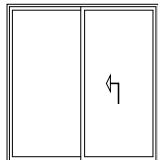

Schema | Type B

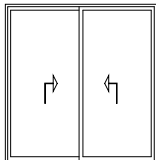

Schema | Type C

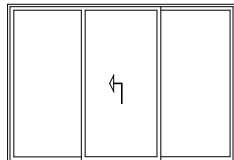

Schema | Type E

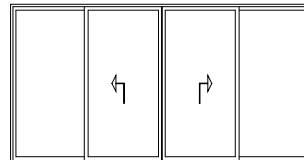

Schema | Type F

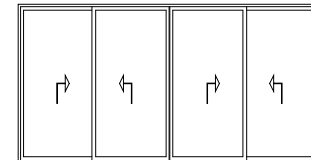

Schema | Type A3

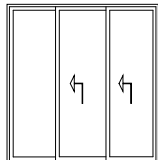

Schema | Type B3

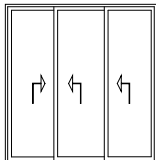

Schema | Type C3

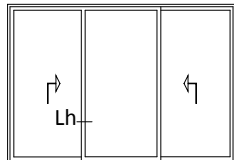

Schema | Type E3

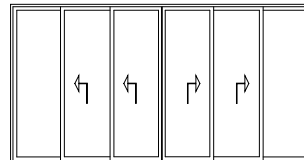

Schema | Type F3

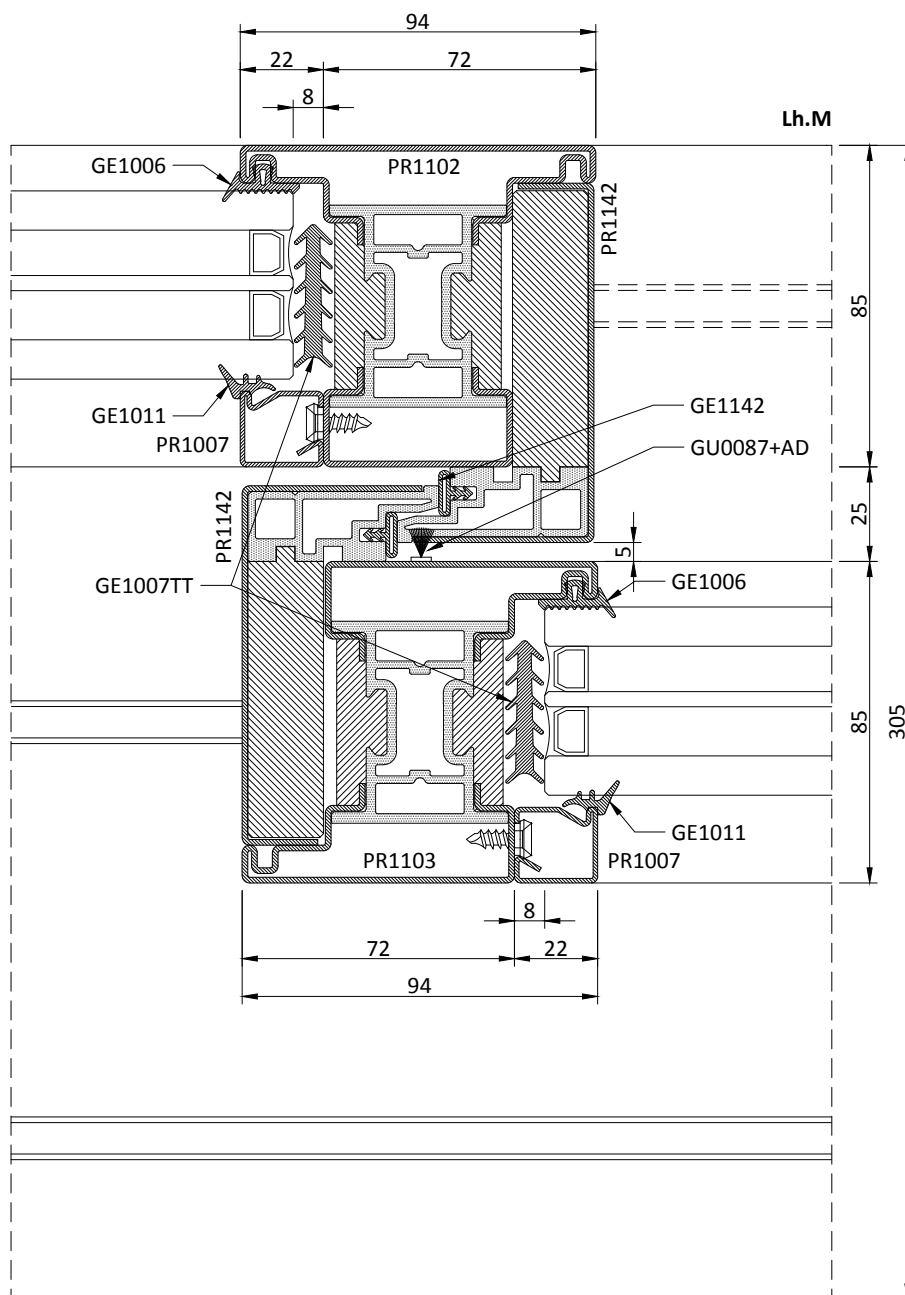
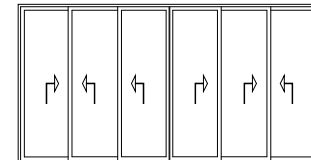

Schema | Type A

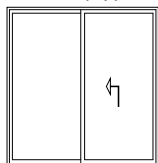

Schema | Type B

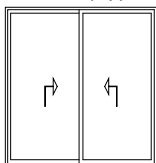

Schema | Type C

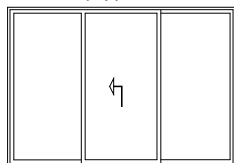

Schema | Type E

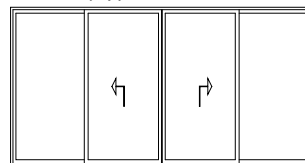

Schema | Type F

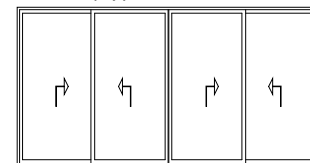

Schema | Type A3

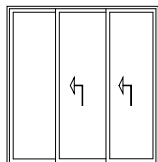

Schema | Type B3

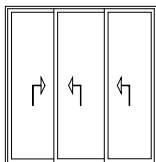

Schema | Type C3

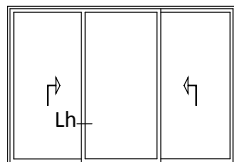

Schema | Type E3

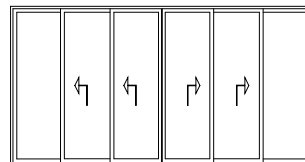

Schema | Type F3

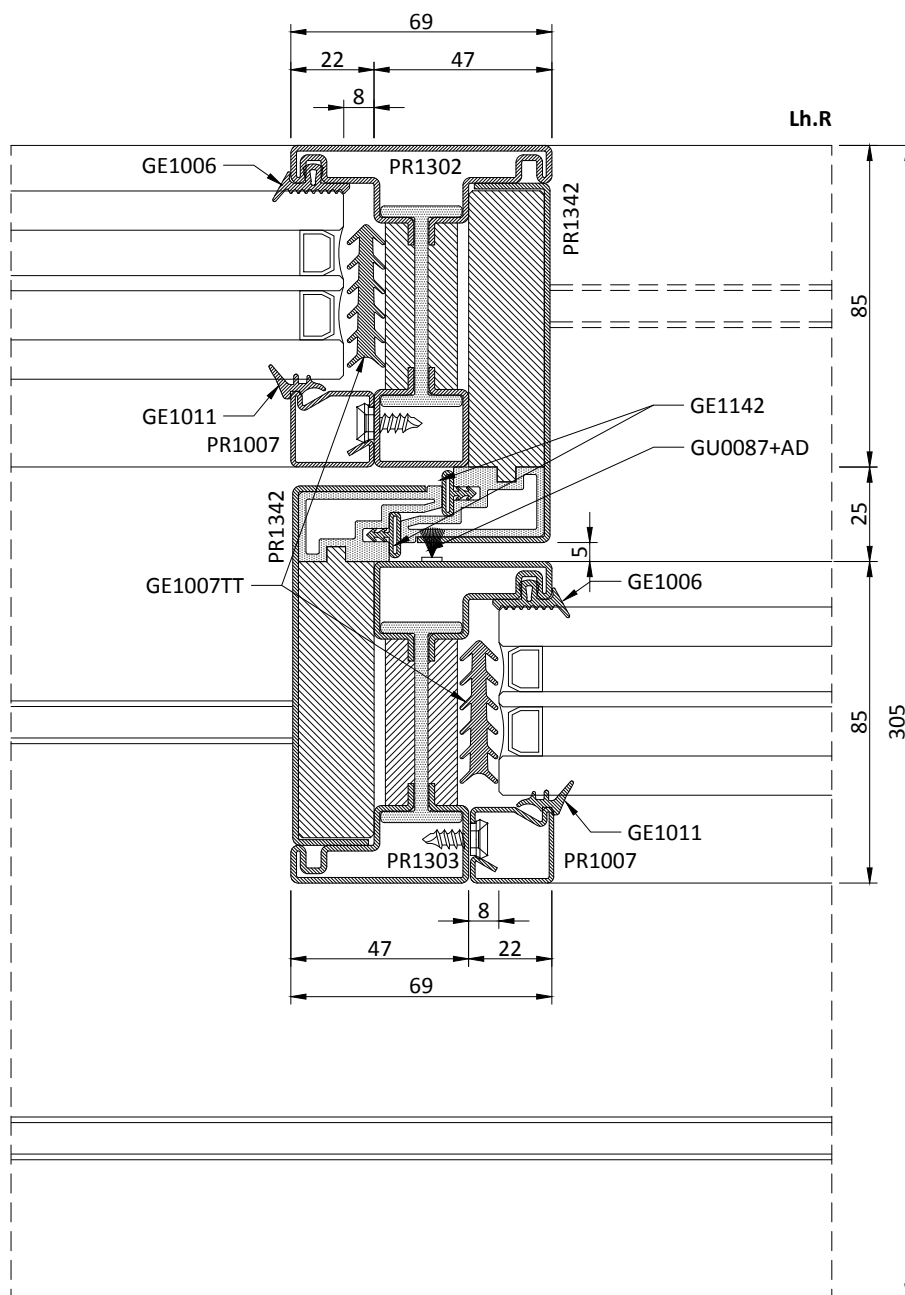
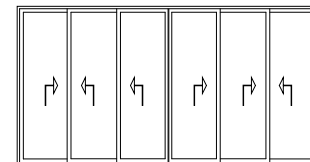



Schema | Type A

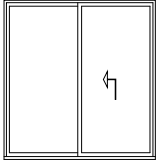

Schema | Type B

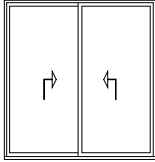

Schema | Type C

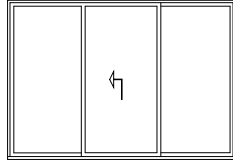

Schema | Type E

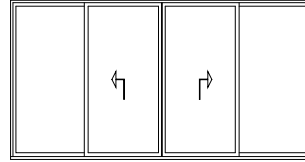

Schema | Type F

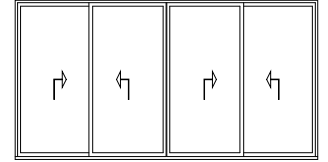

Schema | Type A3

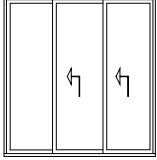

Schema | Type B3

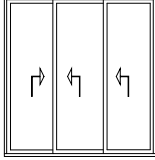

Schema | Type C3

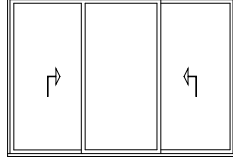

Schema | Type E3



Schema | Type F3

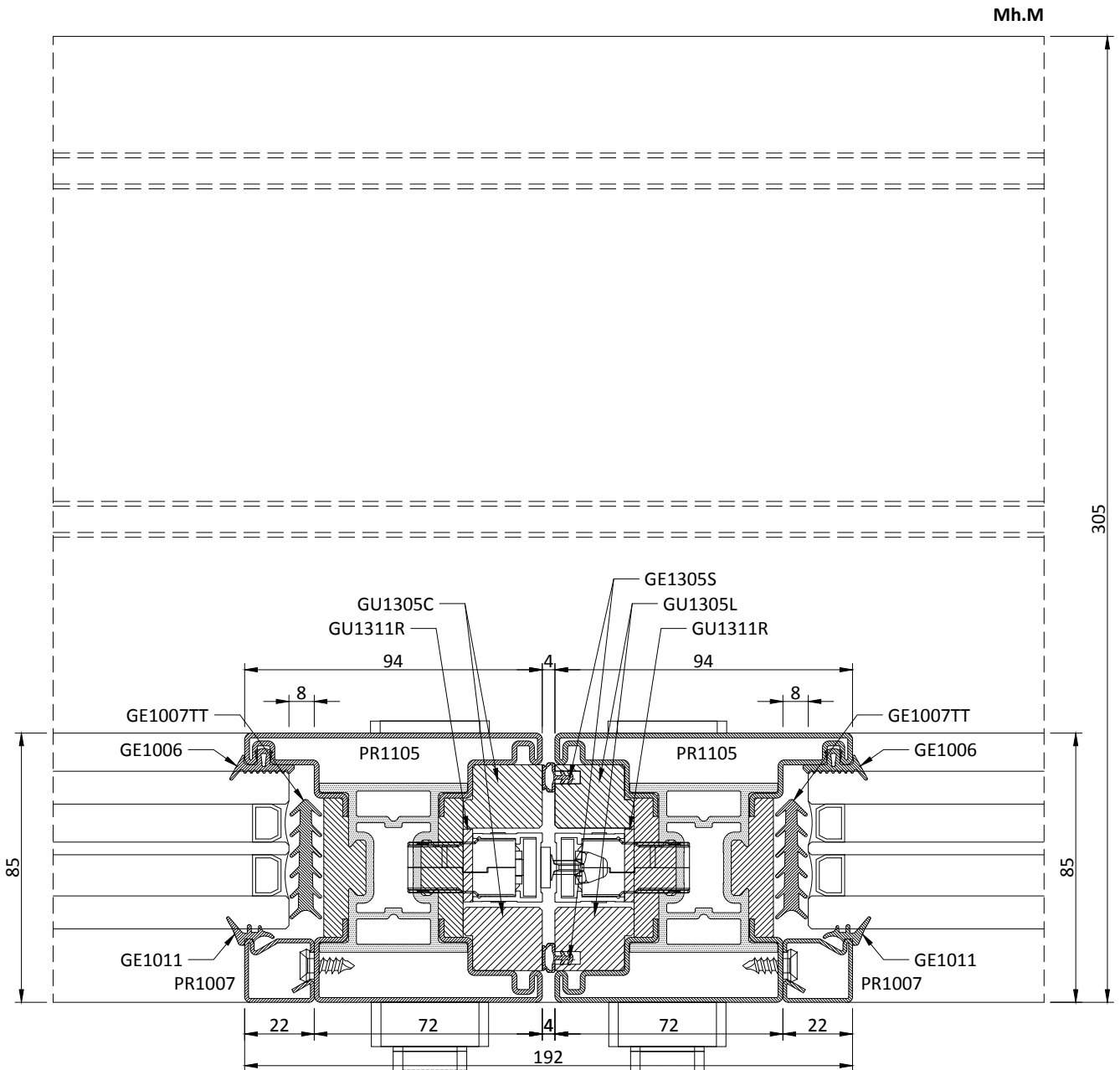
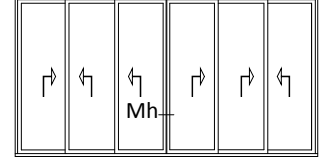

Schema | Type A

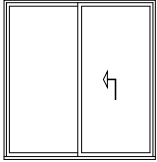

Schema | Type B

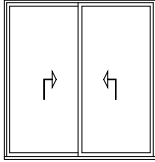

Schema | Type C

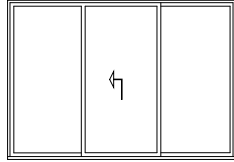

Schema | Type E

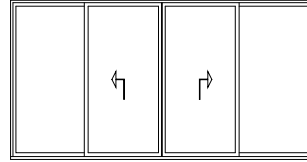

Schema | Type F

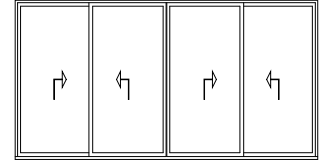

Schema | Type A3

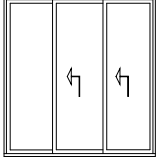

Schema | Type B3

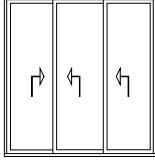

Schema | Type C3

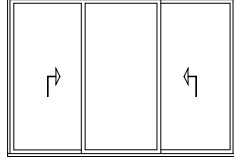

Schema | Type E3



Schema | Type F3

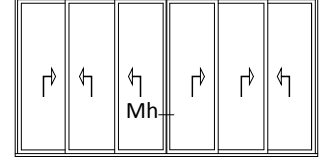

Mh.R

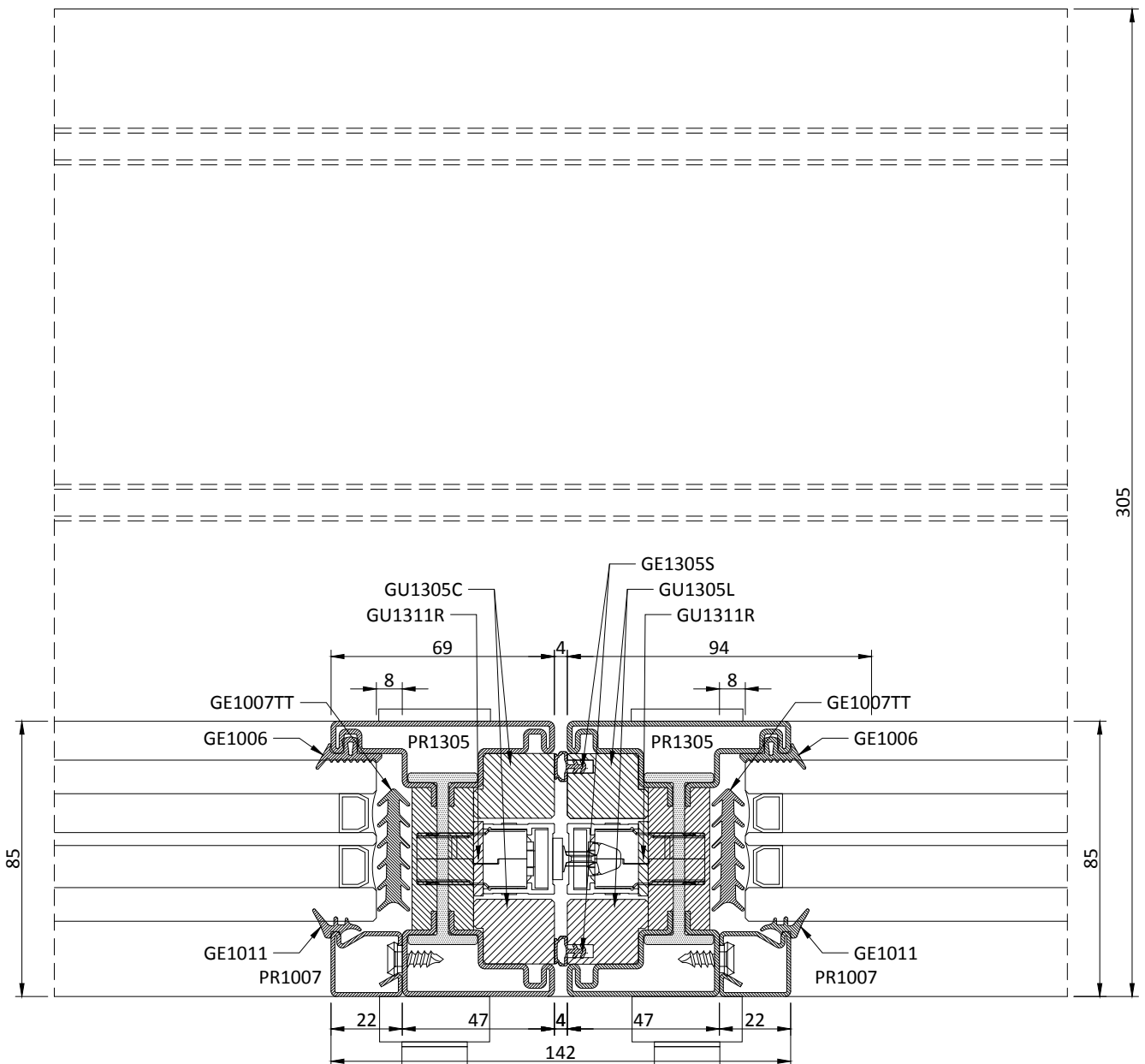

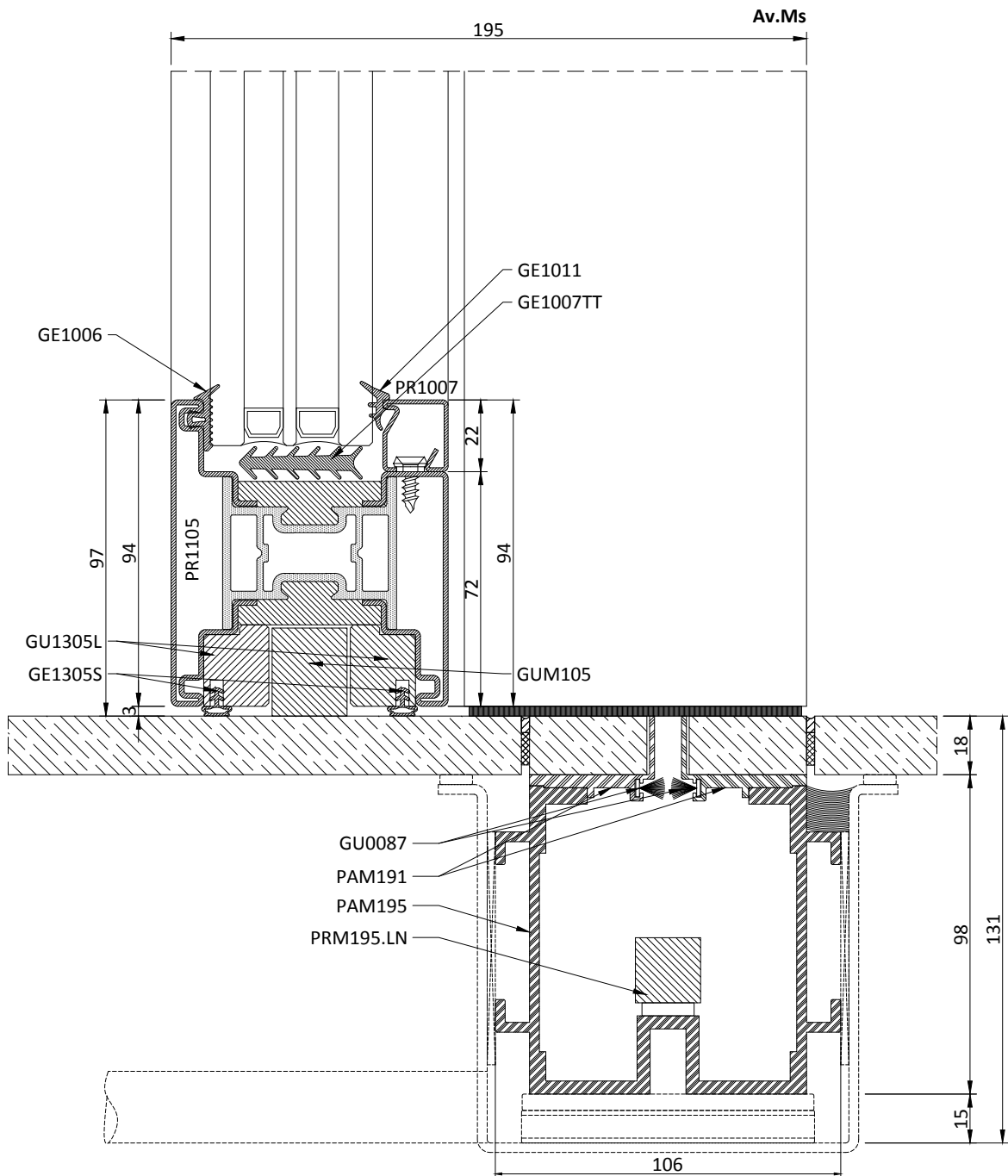
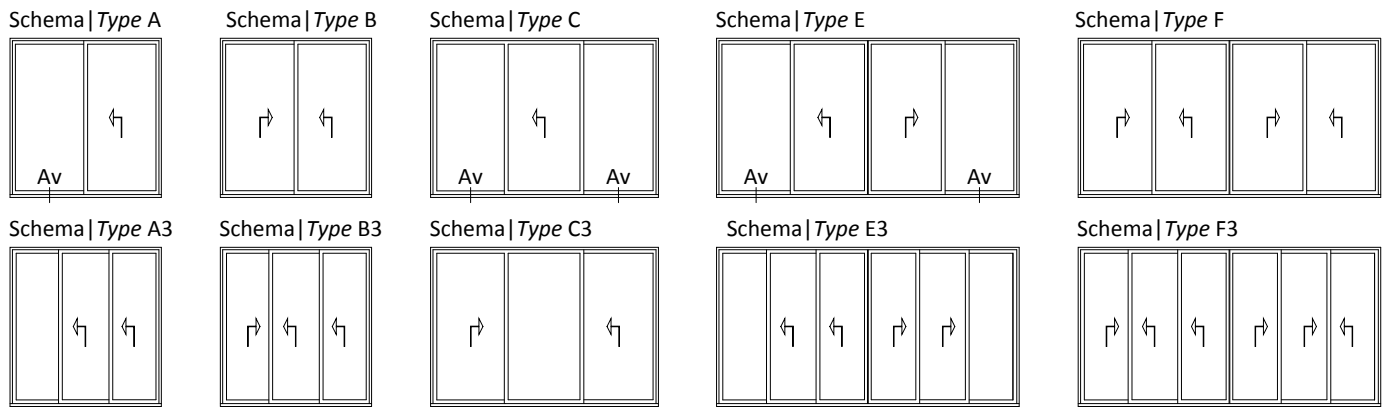

Schema | Type A

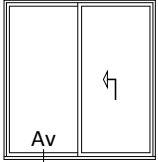

Schema | Type B

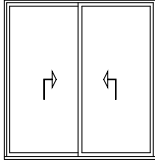

Schema | Type C

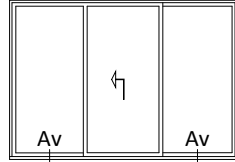

Schema | Type E

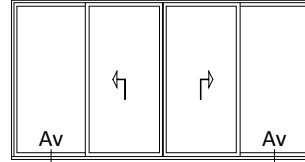

Schema | Type F

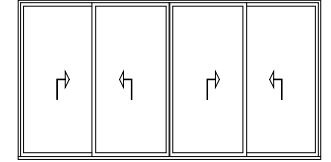

Schema | Type A3

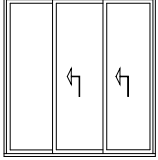

Schema | Type B3

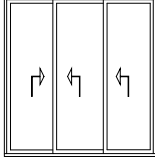

Schema | Type C3

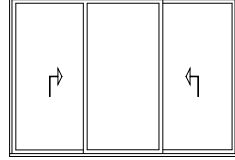

Schema | Type E3

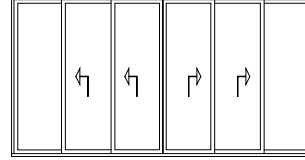

Schema | Type F3

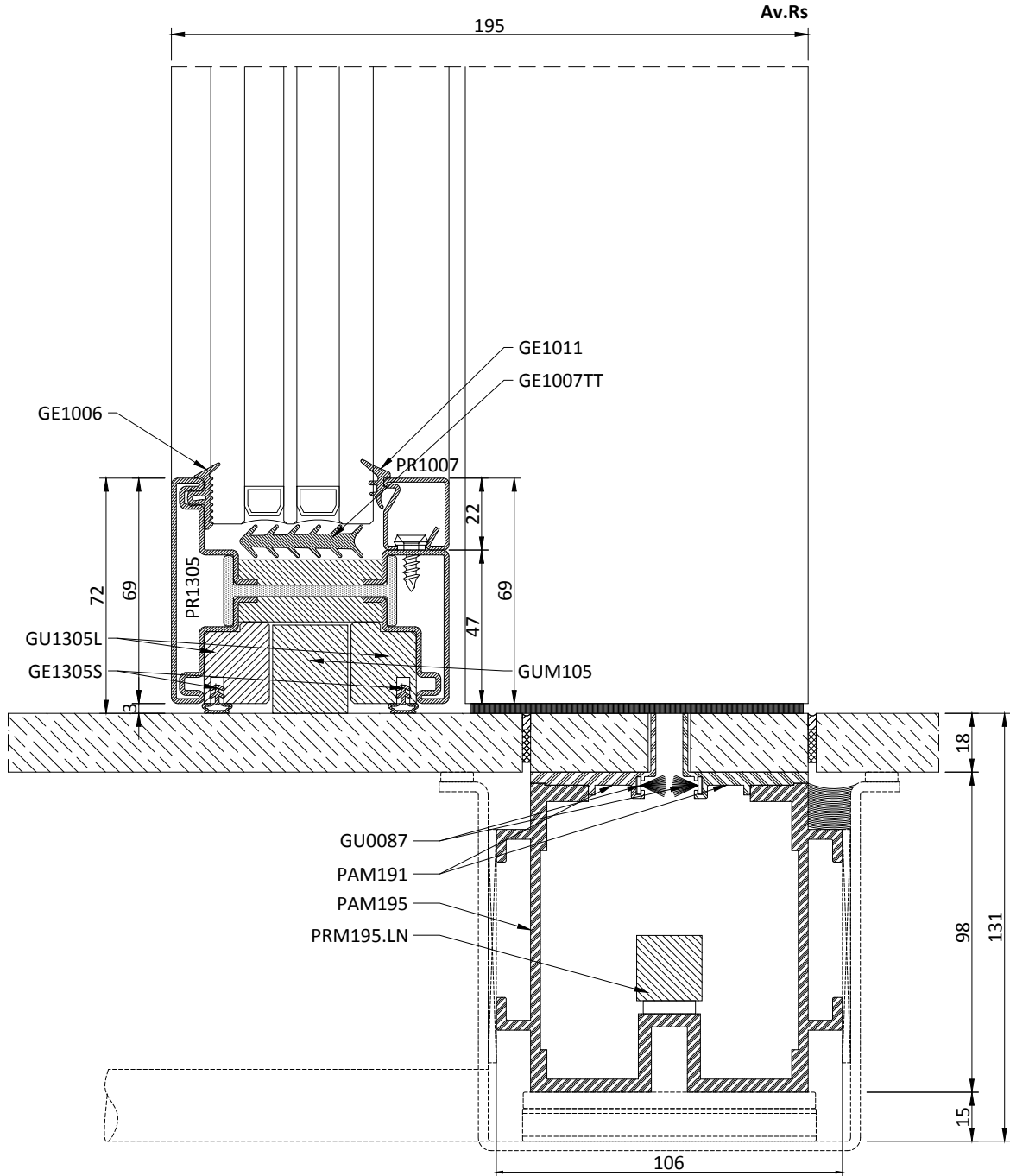
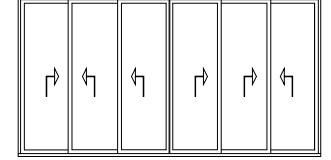

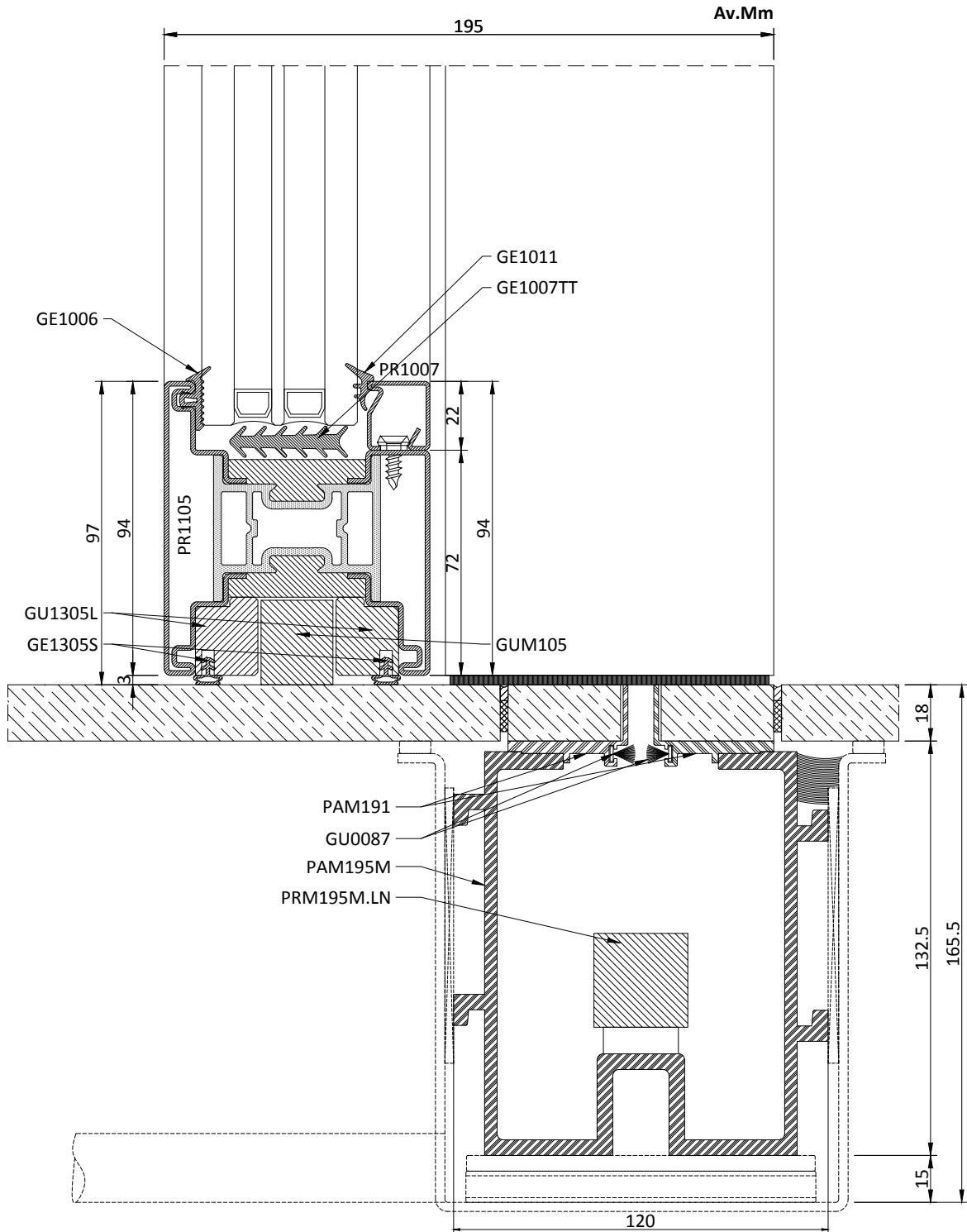
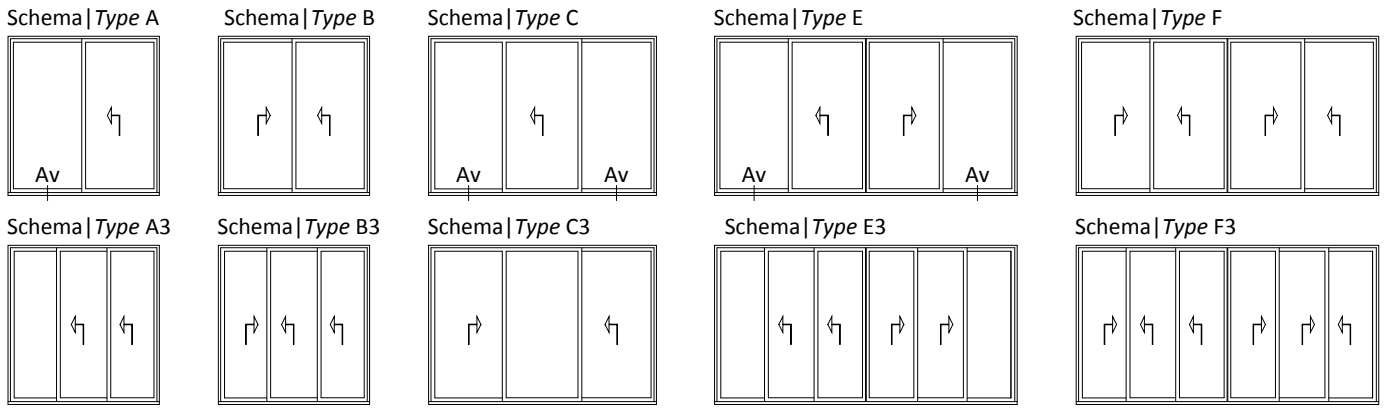

Schema | Type A

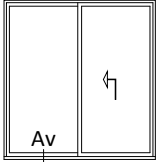

Schema | Type B

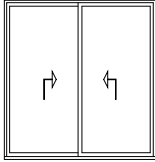

Schema | Type C

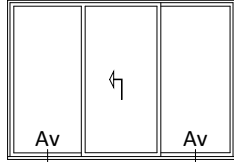

Schema | Type E

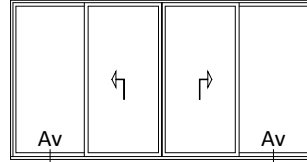

Schema | Type F

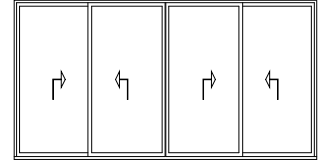

Schema | Type A3

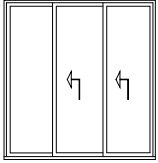

Schema | Type B3

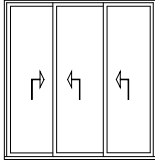

Schema | Type C3

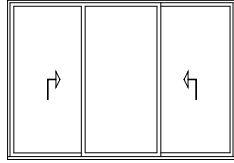

Schema | Type E3

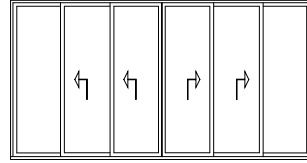

Schema | Type F3

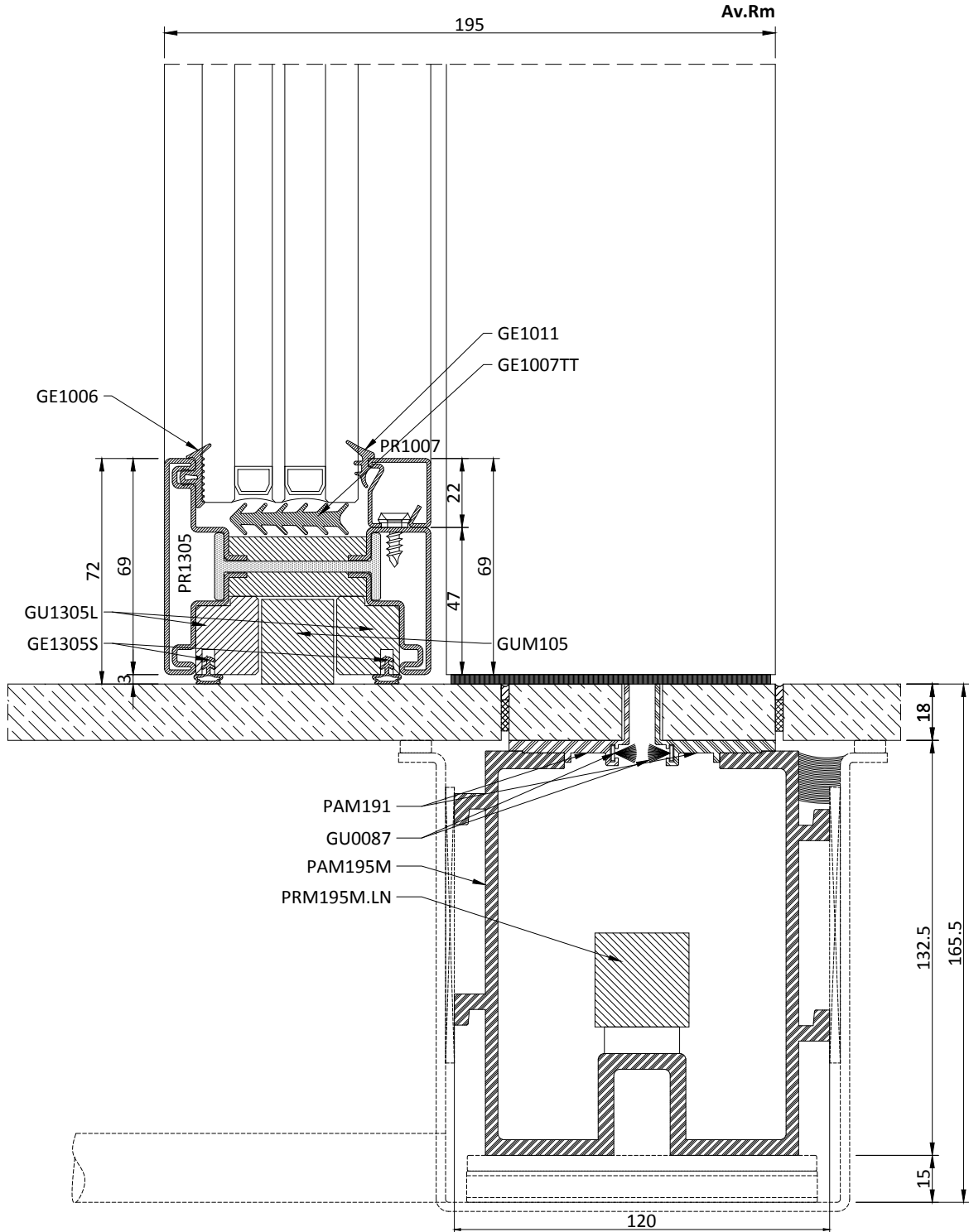
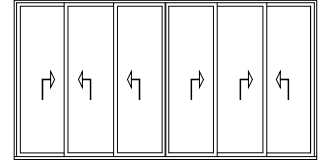

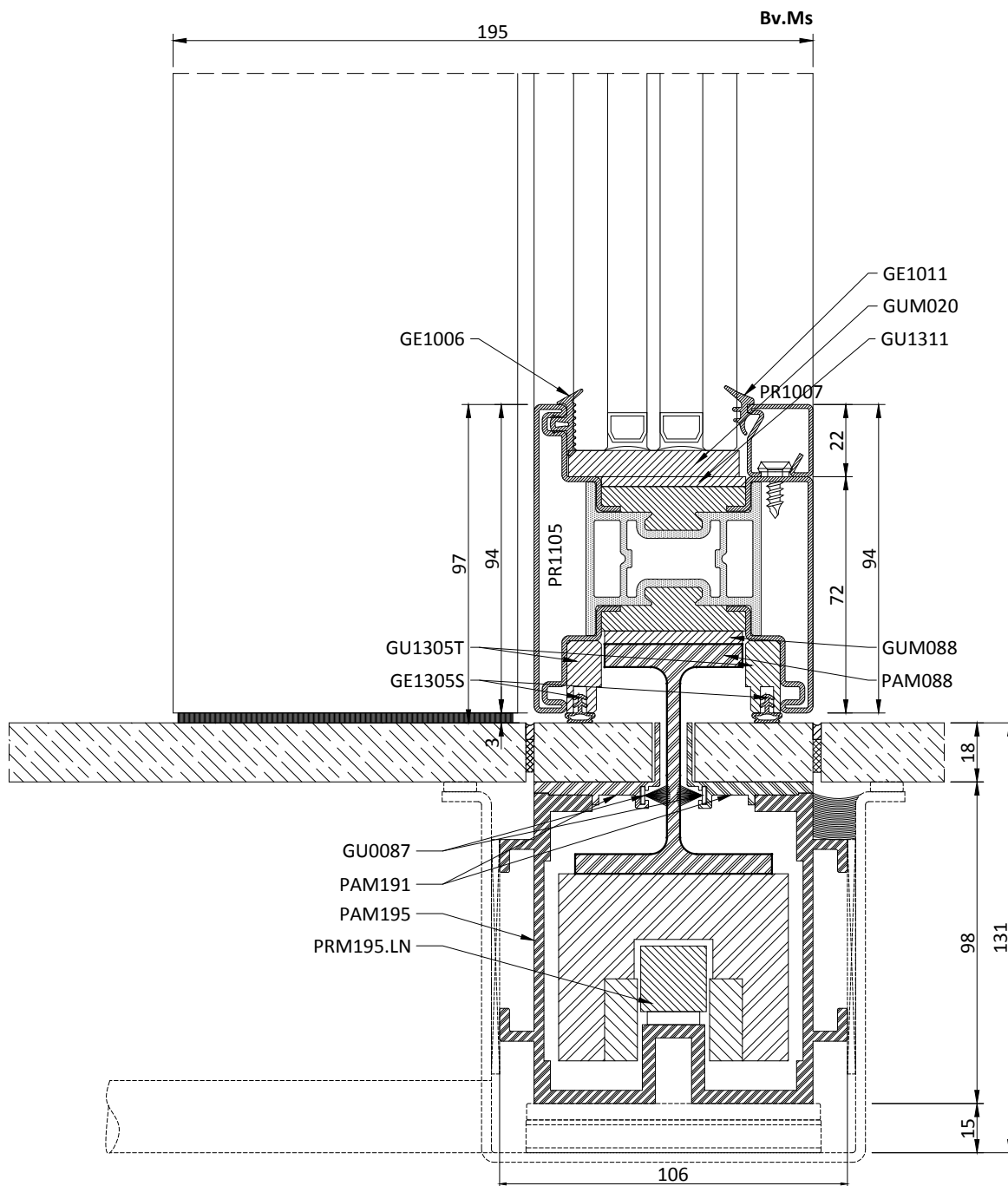
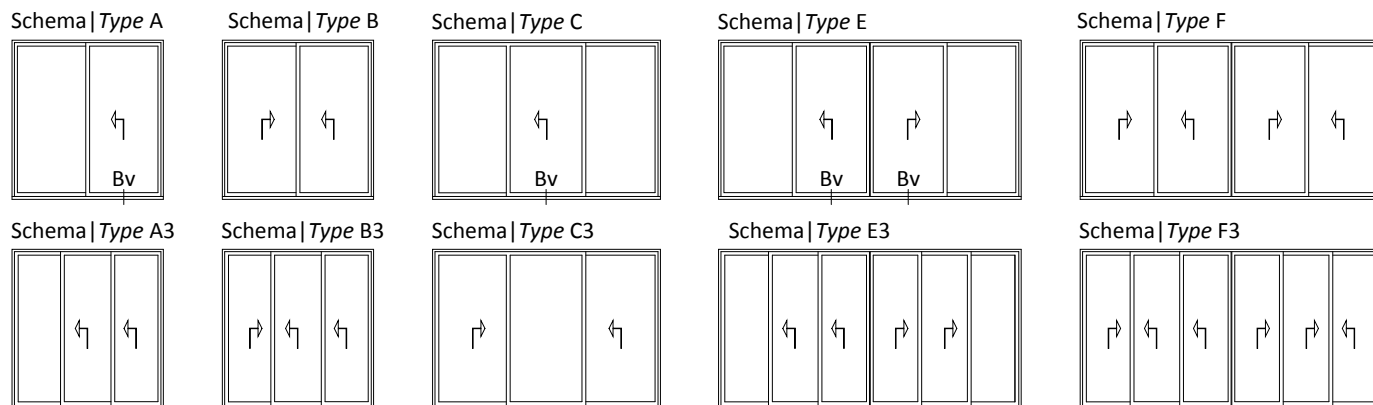

Schema | Type A

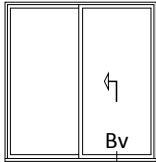

Schema | Type B

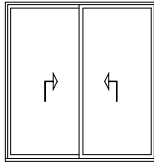

Schema | Type C

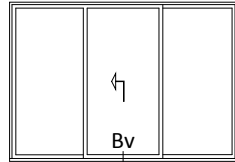

Schema | Type E

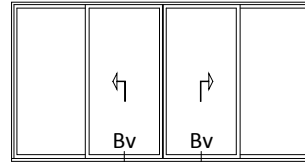

Schema | Type F

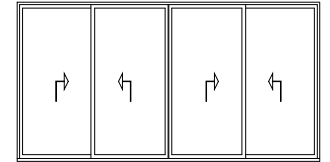

Schema | Type A3

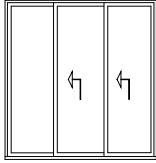

Schema | Type B3

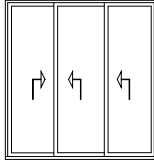

Schema | Type C3

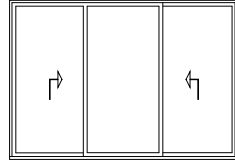

Schema | Type E3

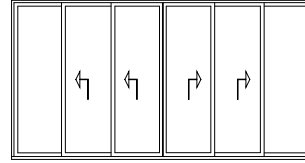

Schema | Type F3

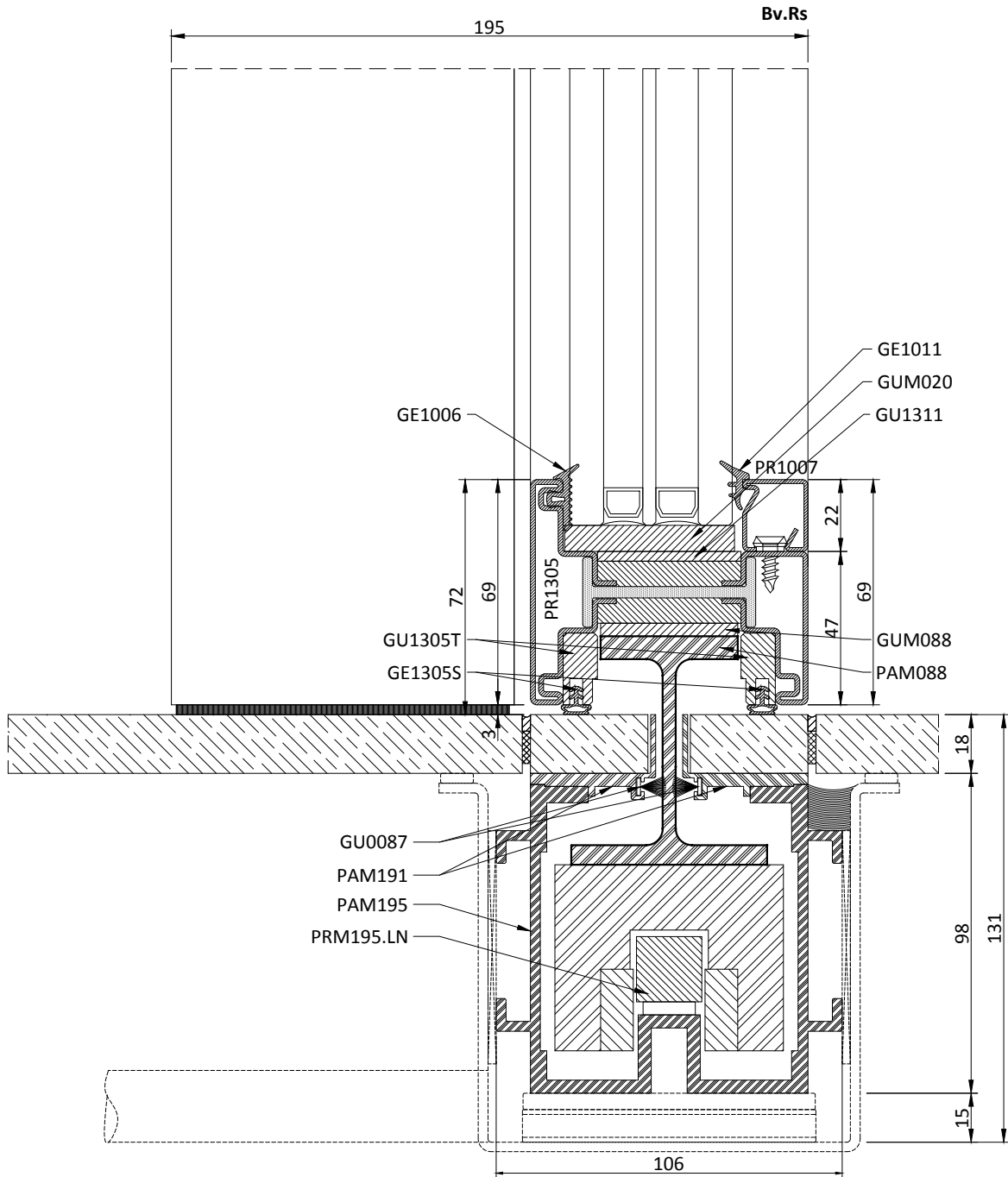
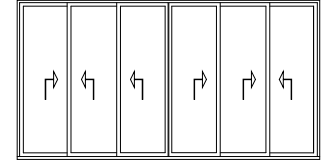



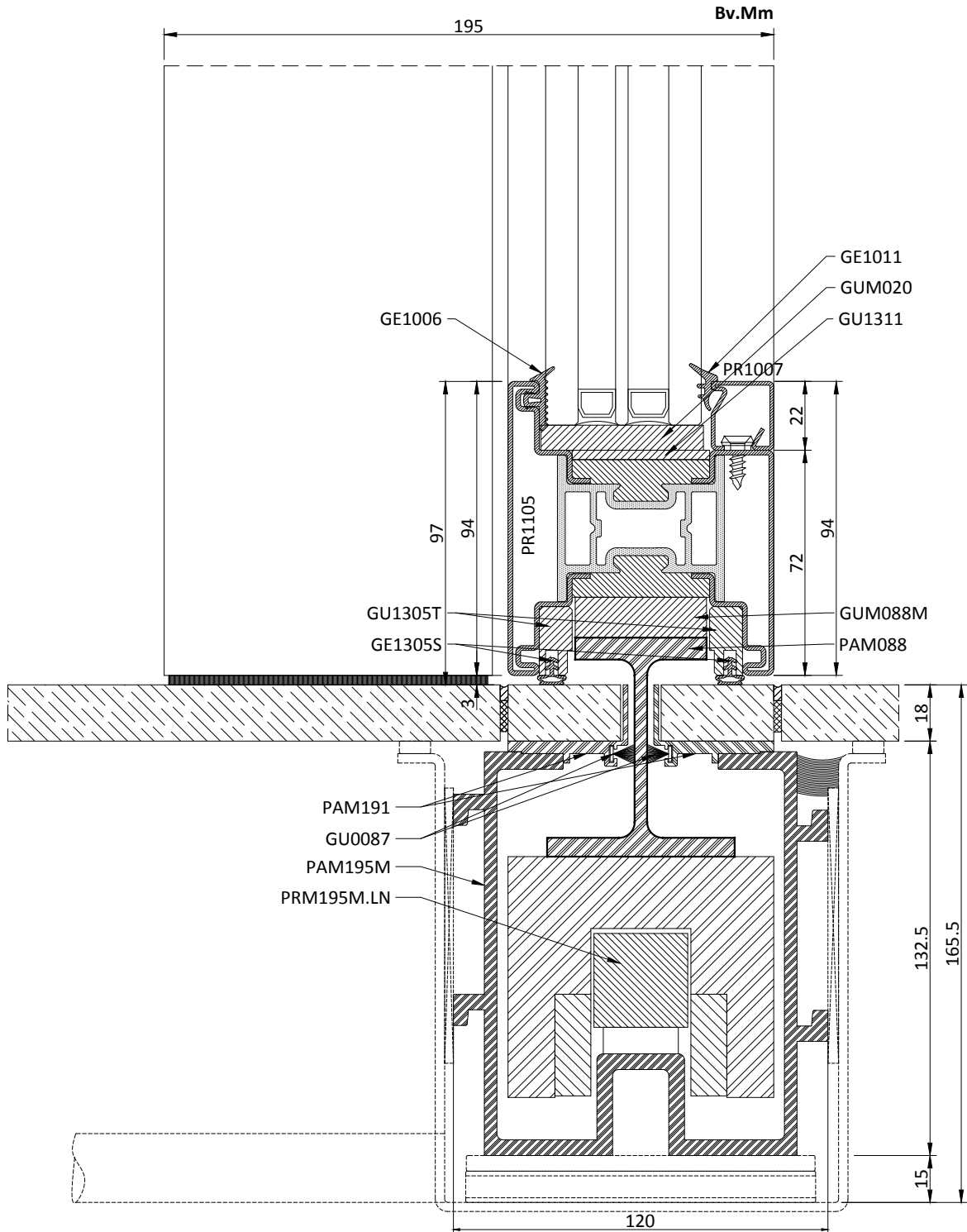
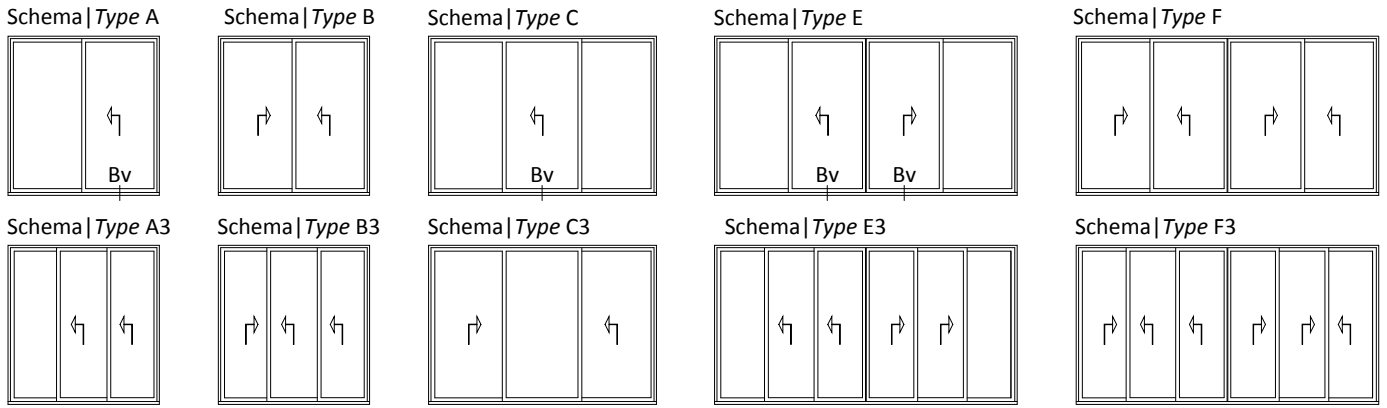

Schema | Type A

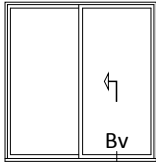

Schema | Type B

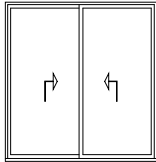

Schema | Type C

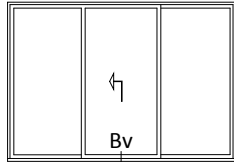

Schema | Type E

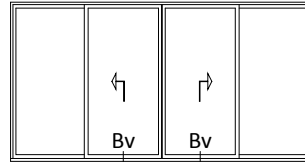

Schema | Type F

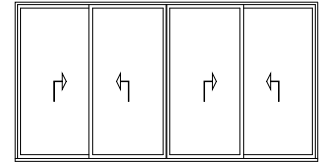

Schema | Type A3

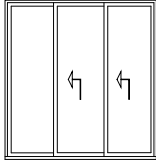

Schema | Type B3

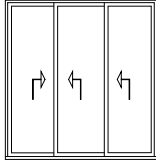

Schema | Type C3

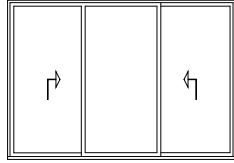

Schema | Type E3

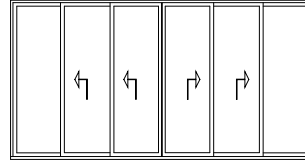

Schema | Type F3

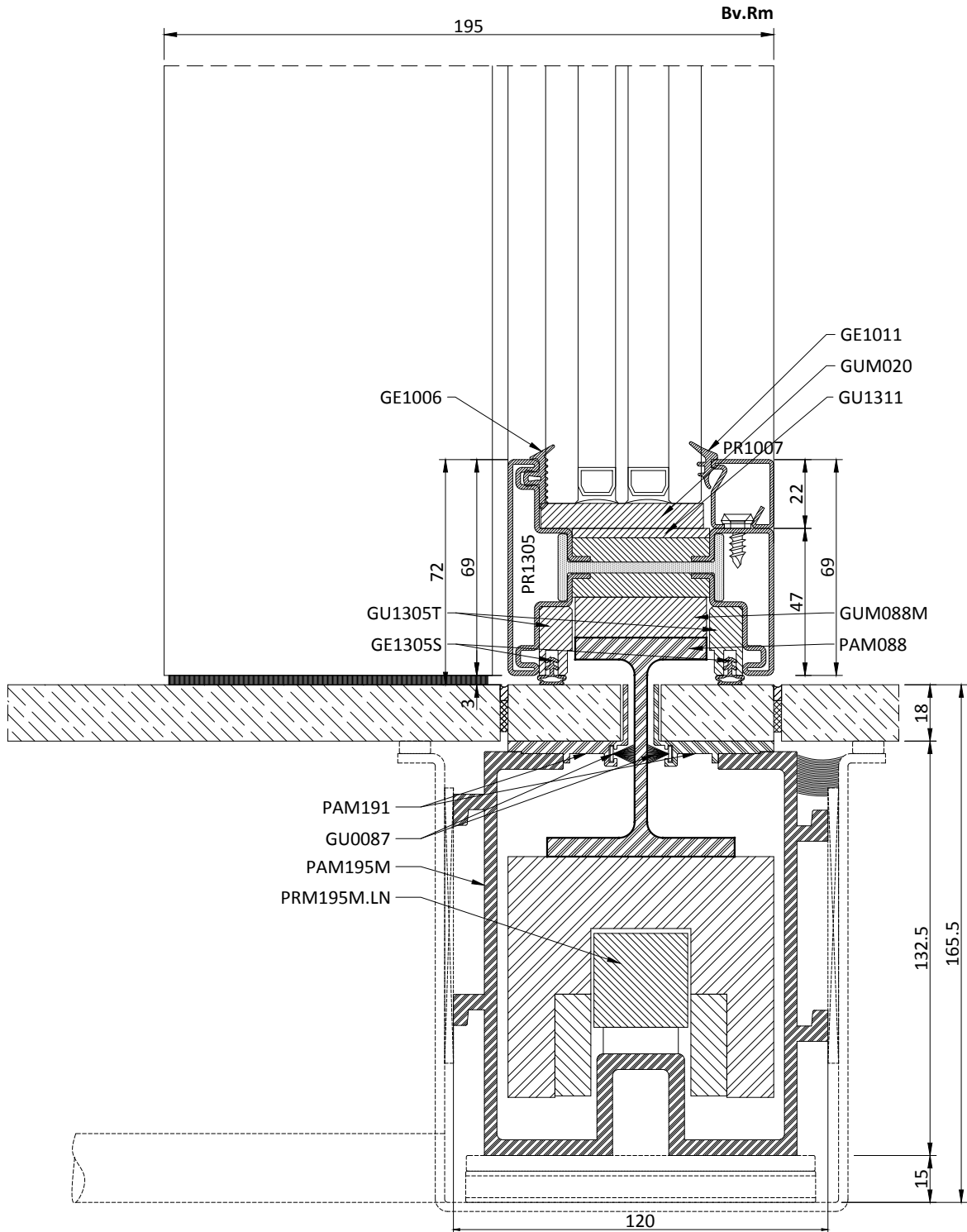
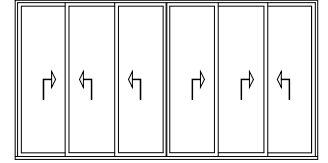

Schema | Type A

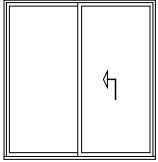

Schema | Type B

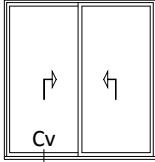

Schema | Type C

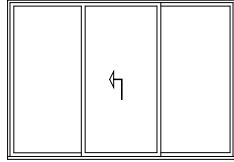

Schema | Type E

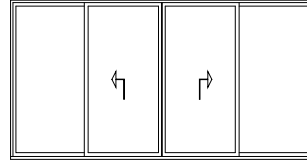

Schema | Type F

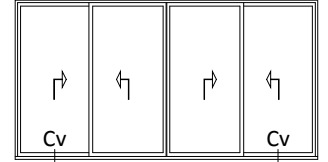

Schema | Type A3

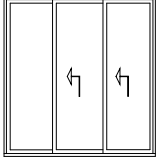

Schema | Type B3

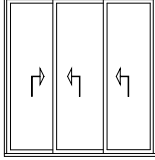

Schema | Type C3

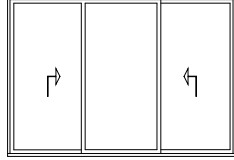

Schema | Type E3

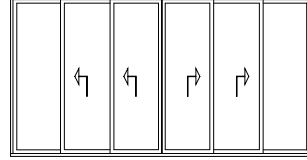

Schema | Type F3

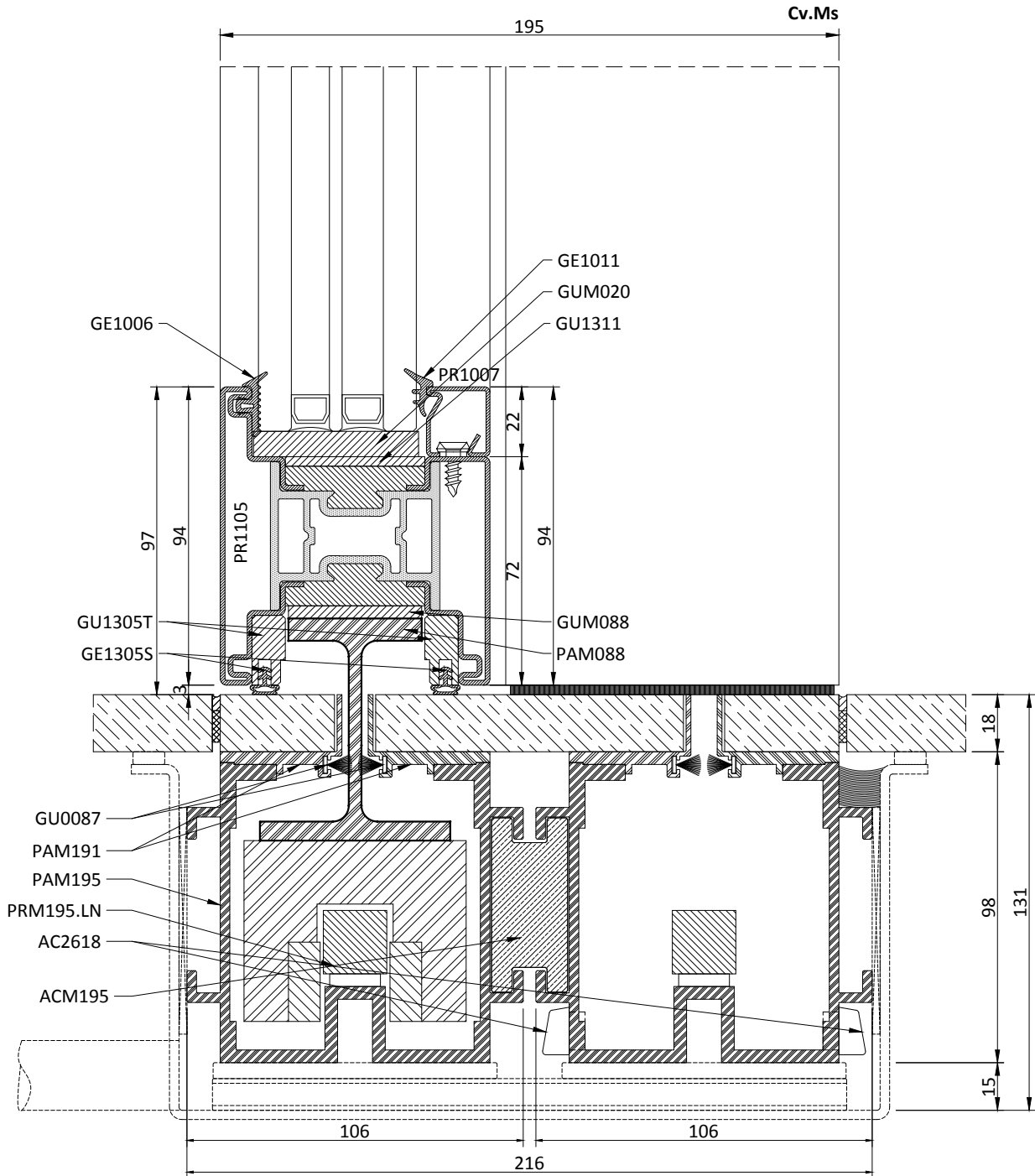
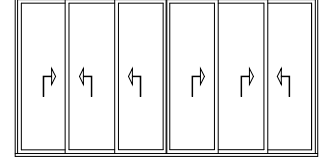

Schema | Type A

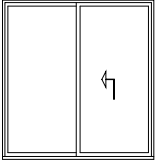

Schema | Type B

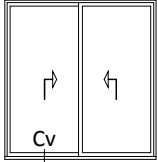

Schema | Type C

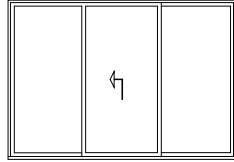

Schema | Type E

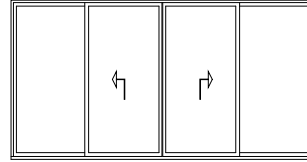

Schema | Type F

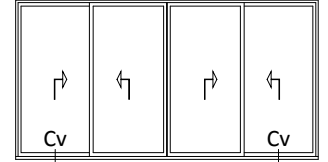

Schema | Type A3

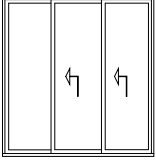

Schema | Type B3

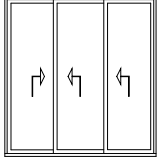

Schema | Type C3

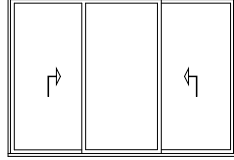

Schema | Type E3

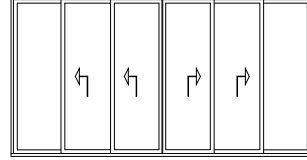

Schema | Type F3

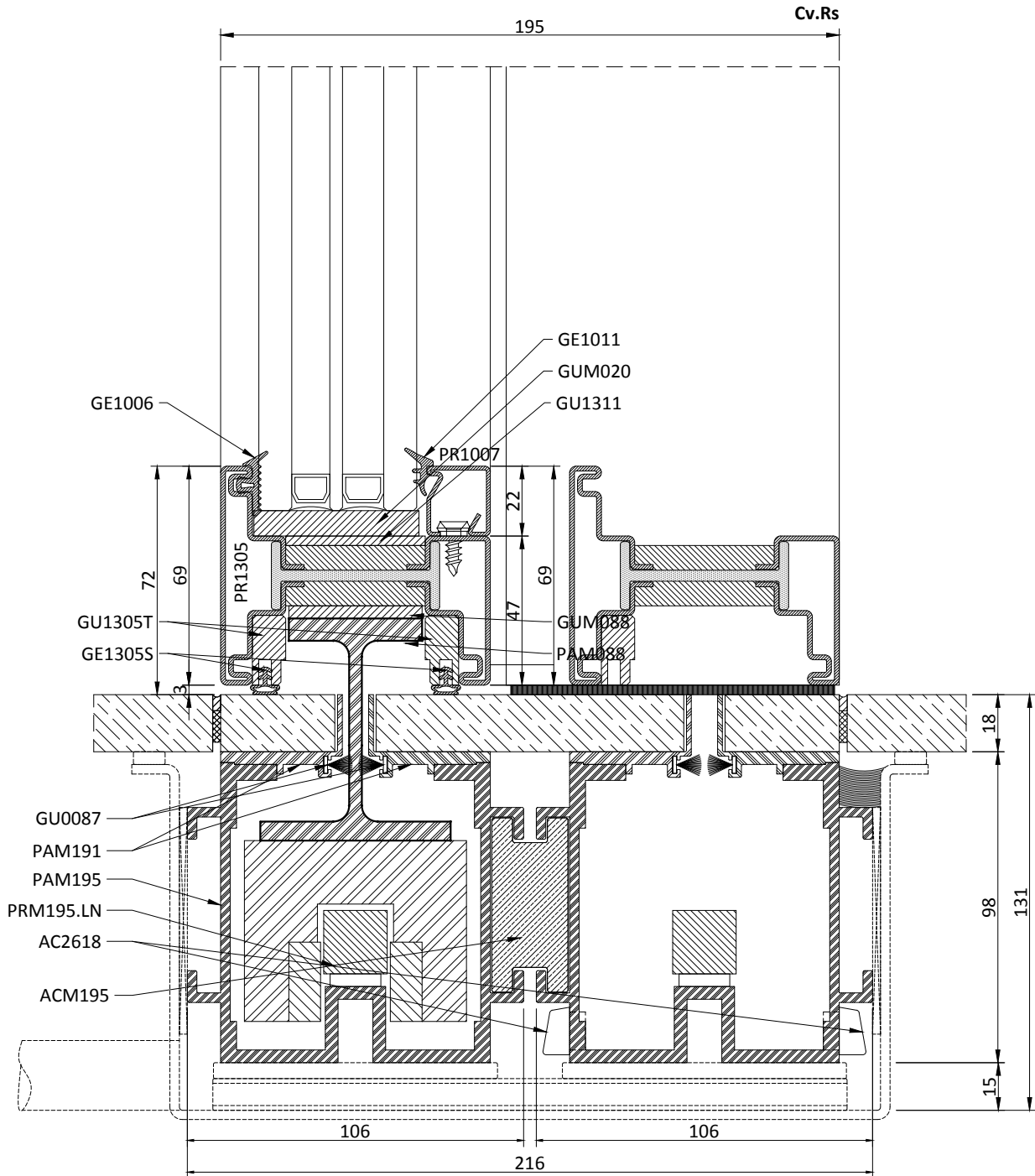
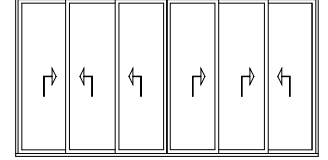

Schema | Type A

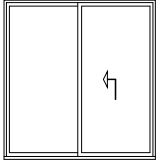

Schema | Type B

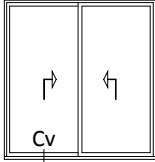

Schema | Type C

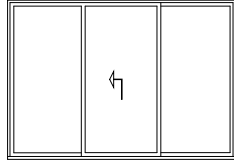

Schema | Type E

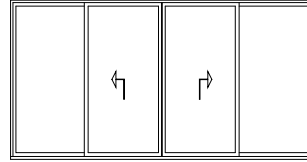

Schema | Type F

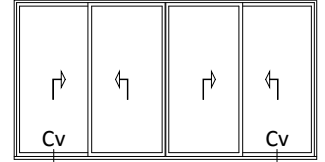

Schema | Type A3

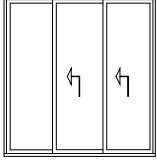

Schema | Type B3

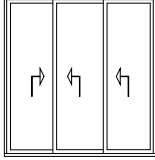

Schema | Type C3

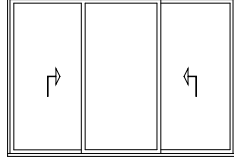

Schema | Type E3

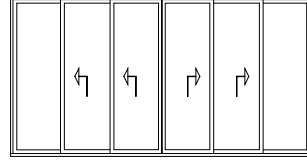

Schema | Type F3

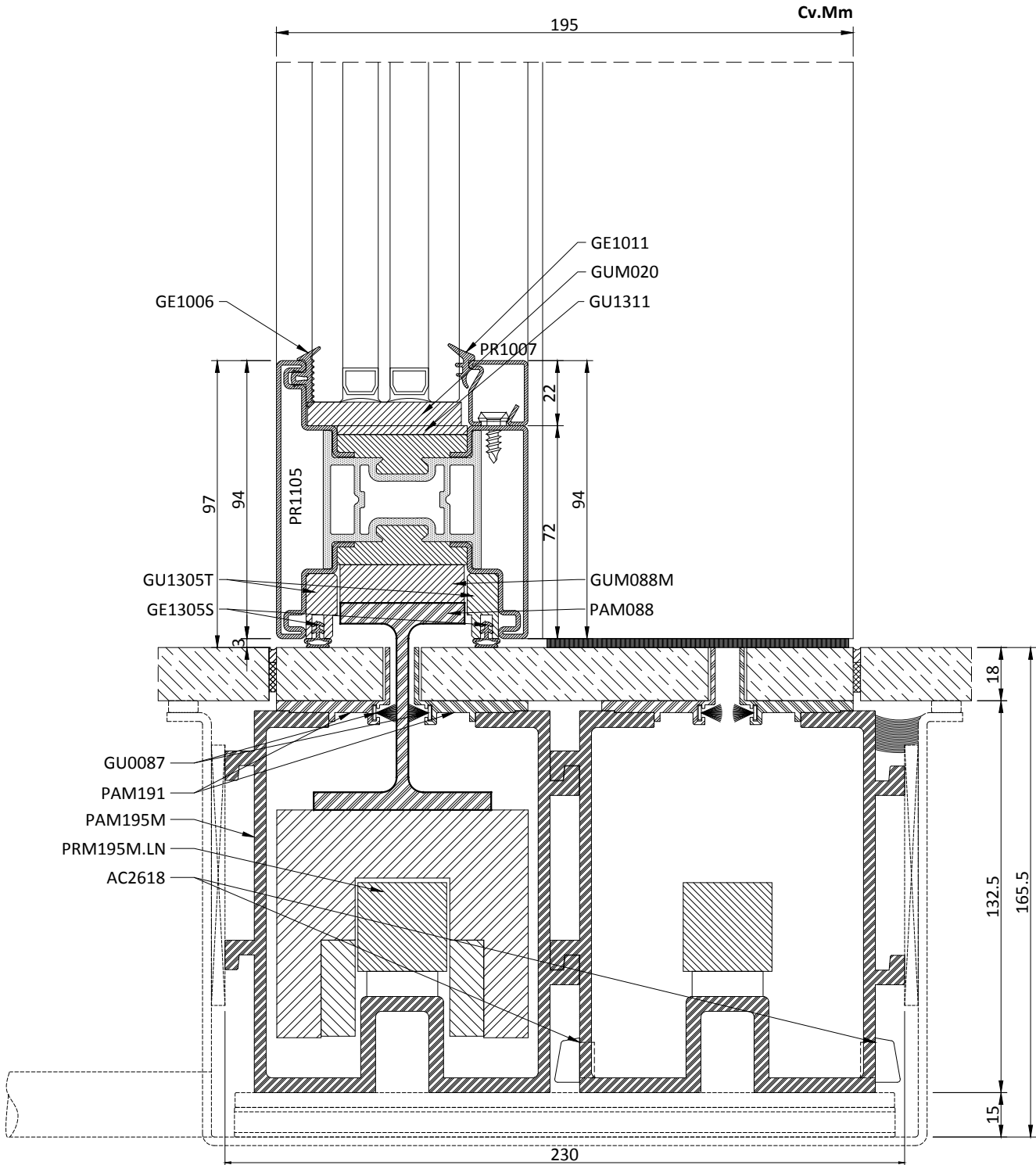
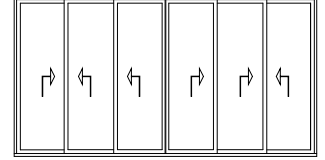

Schema | Type A

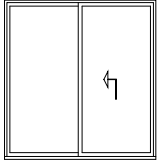

Schema | Type B

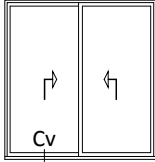

Schema | Type C

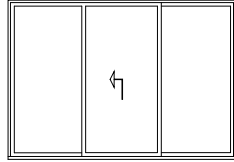

Schema | Type E

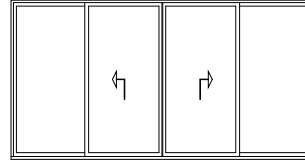

Schema | Type F

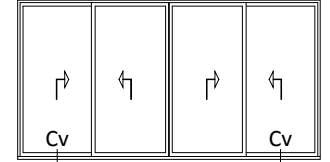

Schema | Type A3

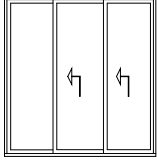

Schema | Type B3

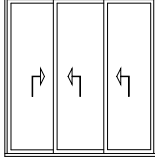

Schema | Type C3

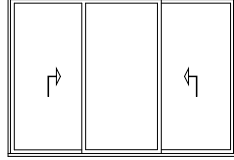

Schema | Type E3

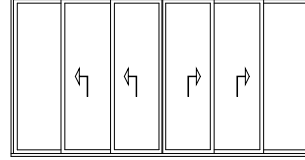

Schema | Type F3

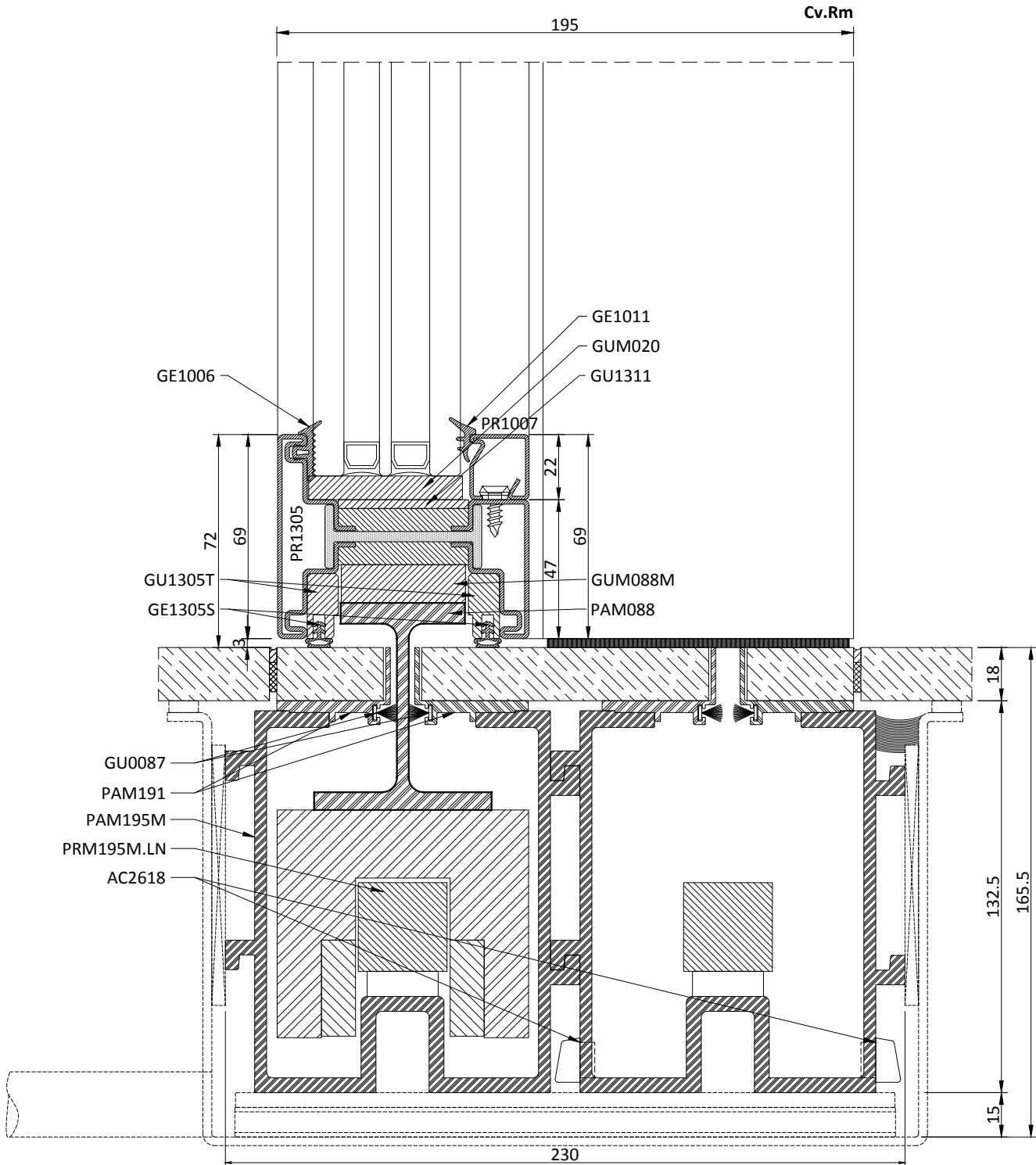
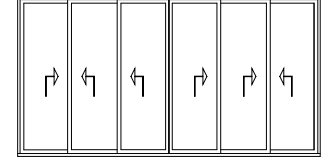

Schema | Type A

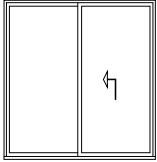

Schema | Type B

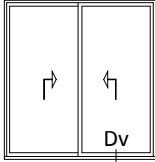

Schema | Type C

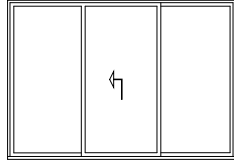

Schema | Type E

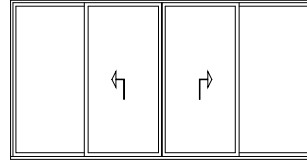

Schema | Type F

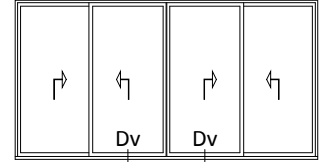

Schema | Type A3

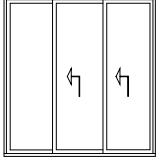

Schema | Type B3

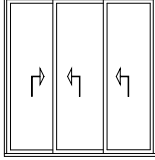

Schema | Type C3

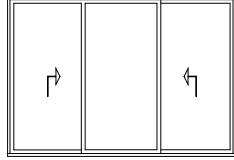

Schema | Type E3

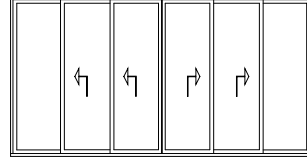

Schema | Type F3

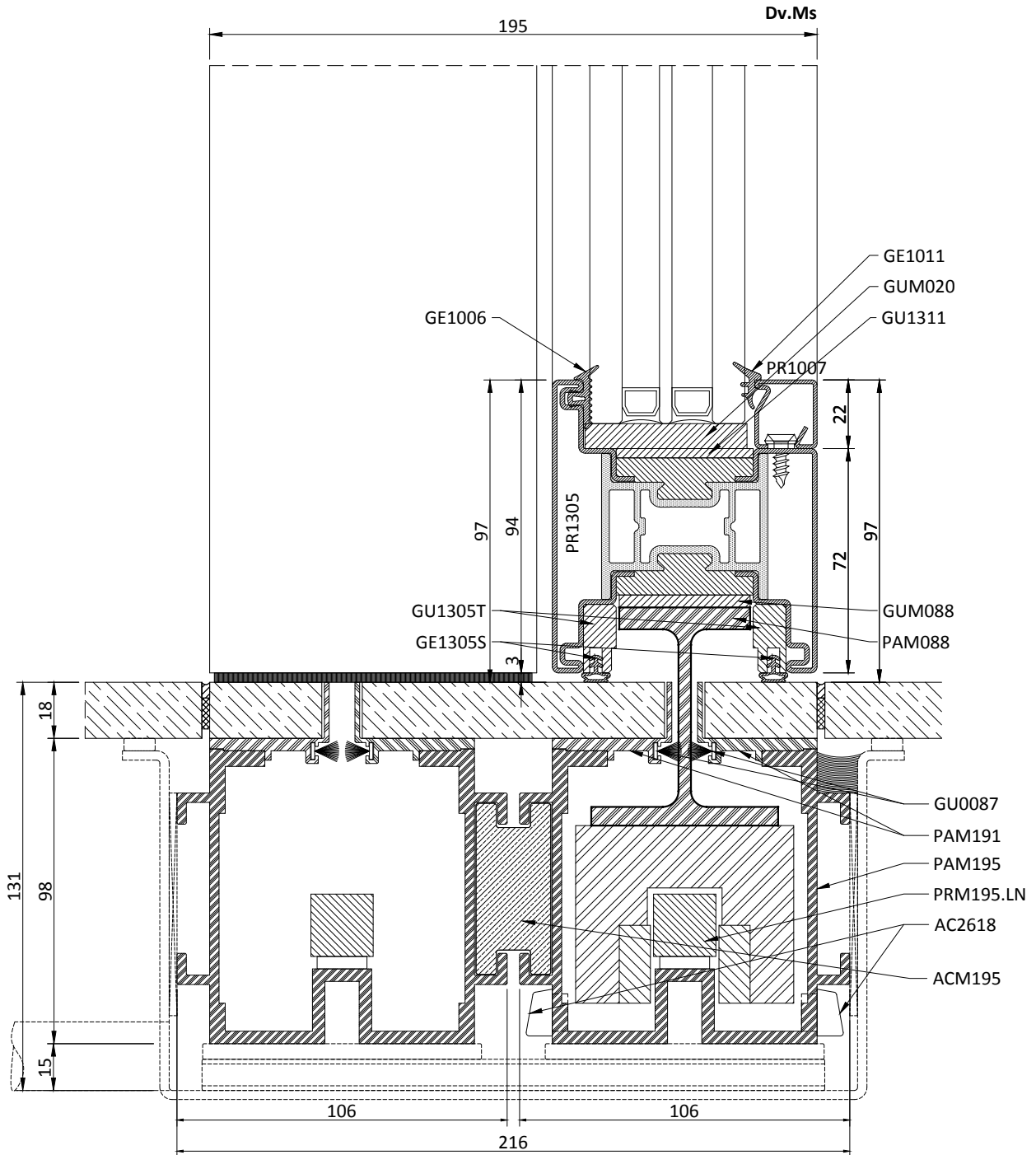
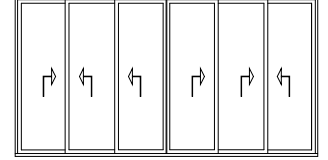

Schema | Type A

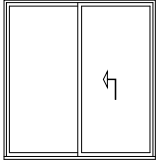

Schema | Type B

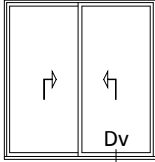

Schema | Type C

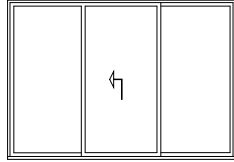

Schema | Type E

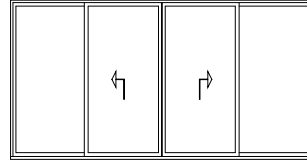

Schema | Type F

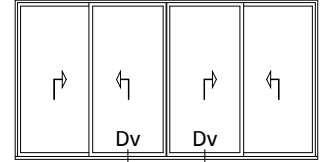

Schema | Type A3

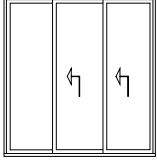

Schema | Type B3

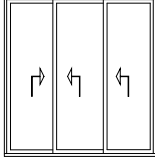

Schema | Type C3

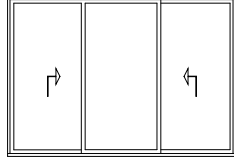

Schema | Type E3

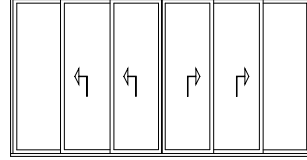

Schema | Type F3

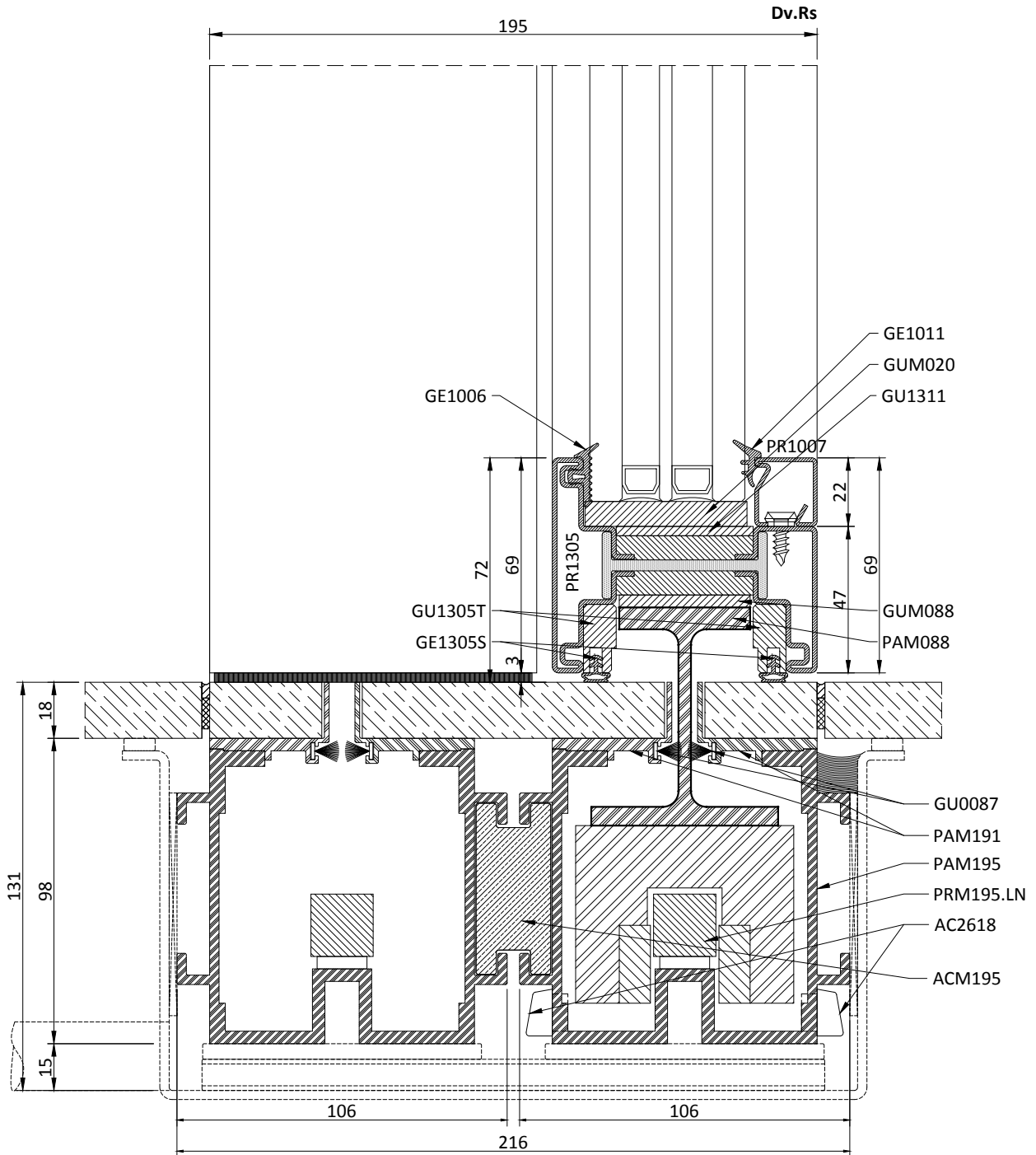
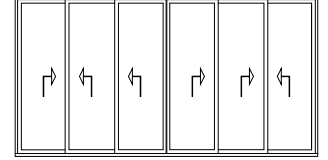



Schema | Type A

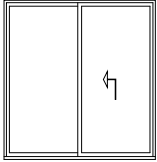

Schema | Type B

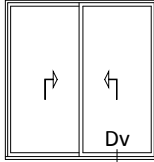

Schema | Type C

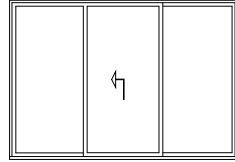

Schema | Type E

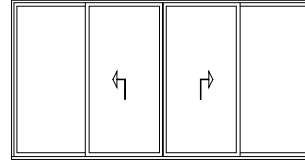

Schema | Type F

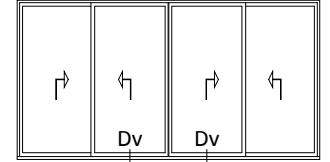

Schema | Type A3

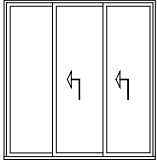

Schema | Type B3

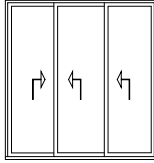

Schema | Type C3

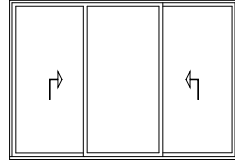

Schema | Type E3

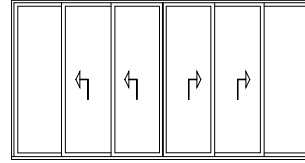

Schema | Type F3

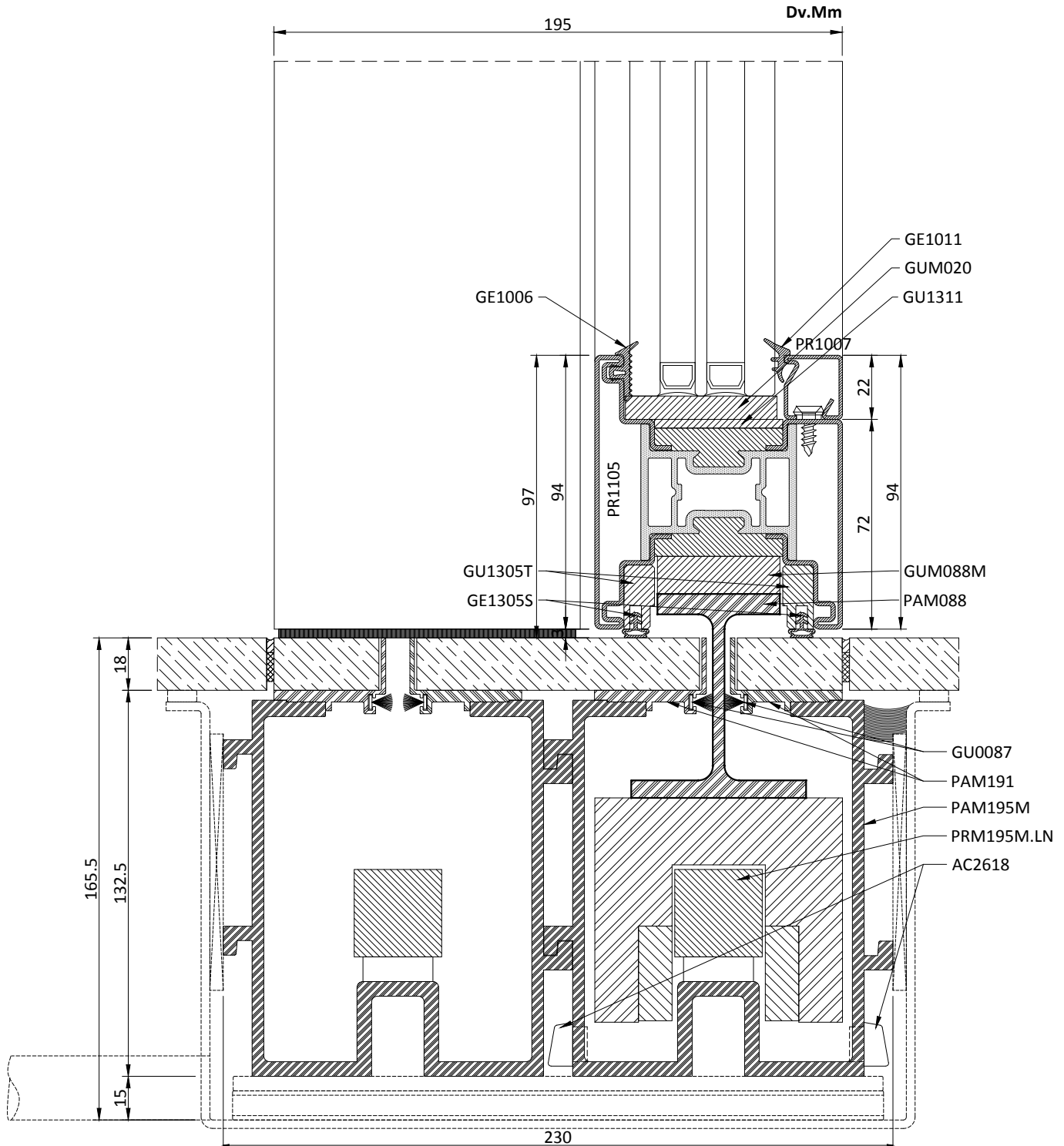
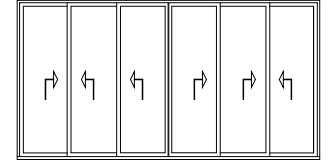

Schema | Type A

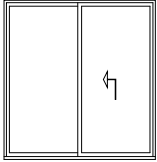

Schema | Type B

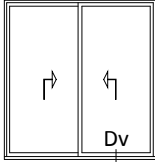

Schema | Type C

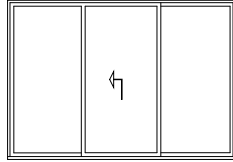

Schema | Type E

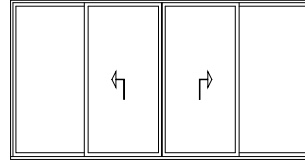

Schema | Type F

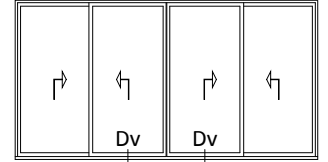

Schema | Type A3

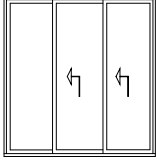

Schema | Type B3

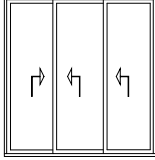

Schema | Type C3

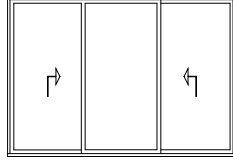

Schema | Type E3

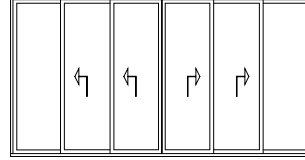

Schema | Type F3

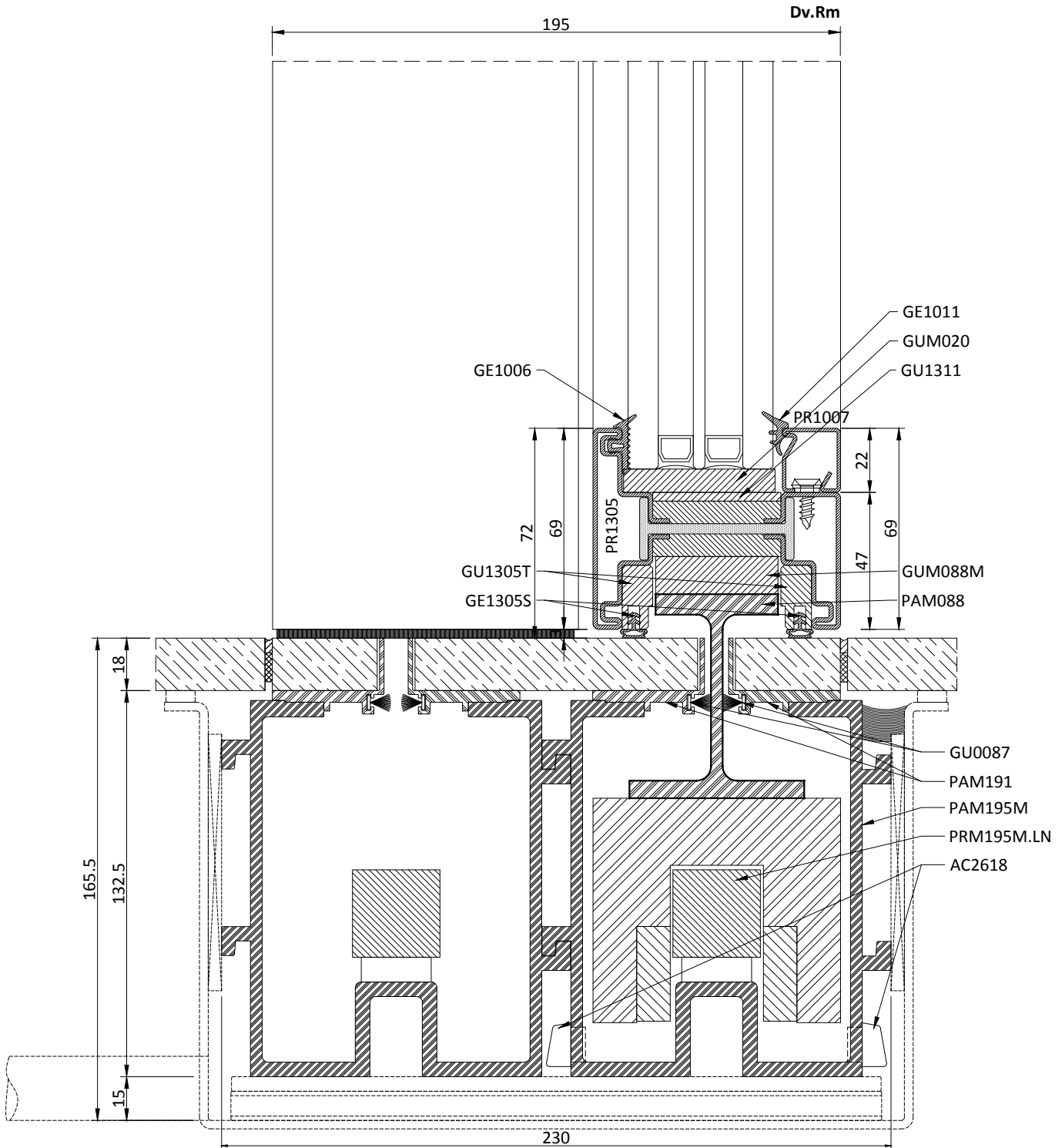
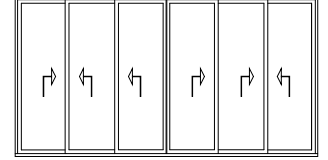

Schema | Type A

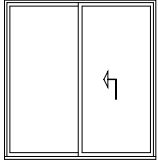

Schema | Type B

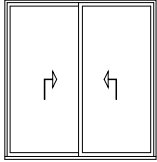

Schema | Type C

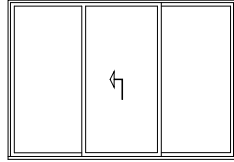

Schema | Type E

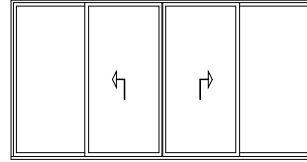

Schema | Type F

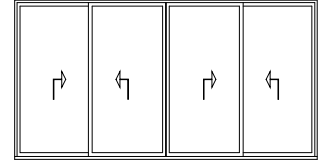

Schema | Type A3

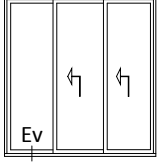

Schema | Type B3

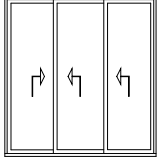

Schema | Type C3

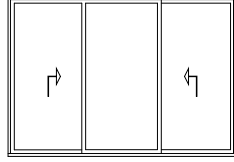

Schema | Type E3

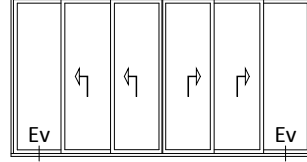

Schema | Type F3

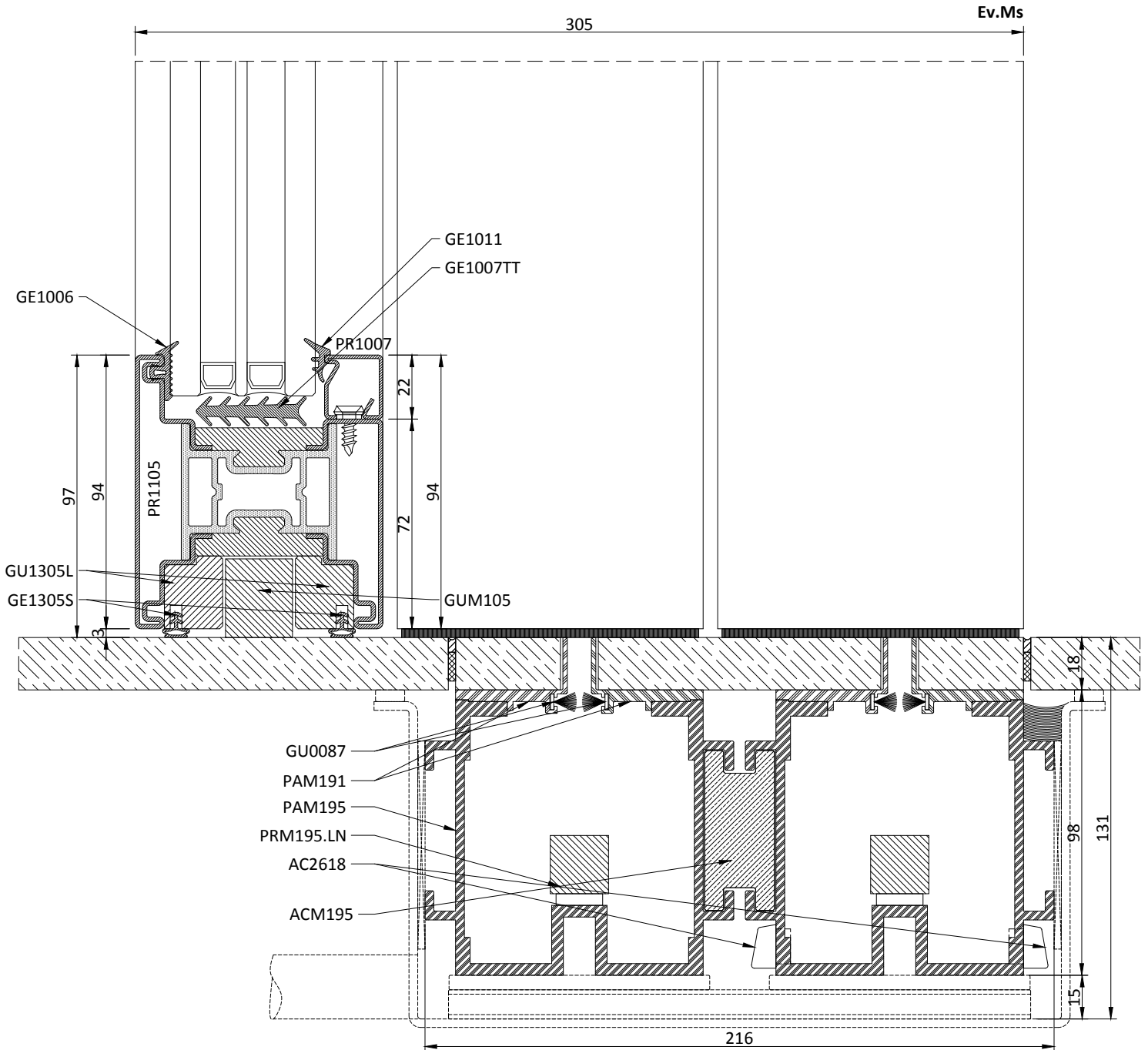
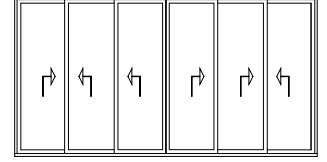

Schema | Type A

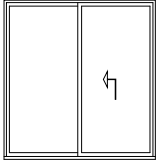

Schema | Type B

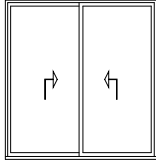

Schema | Type C

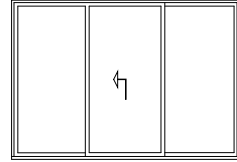

Schema | Type E

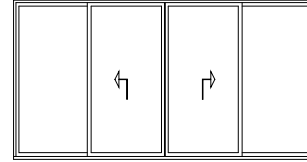

Schema | Type F

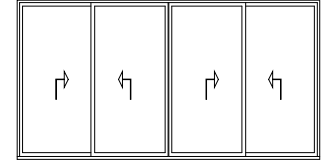

Schema | Type A3

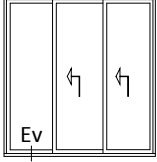

Schema | Type B3

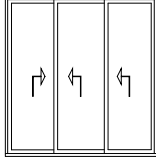

Schema | Type C3

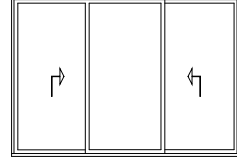

Schema | Type E3

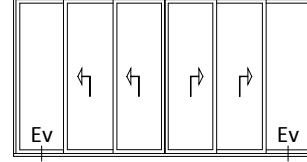

Schema | Type F3

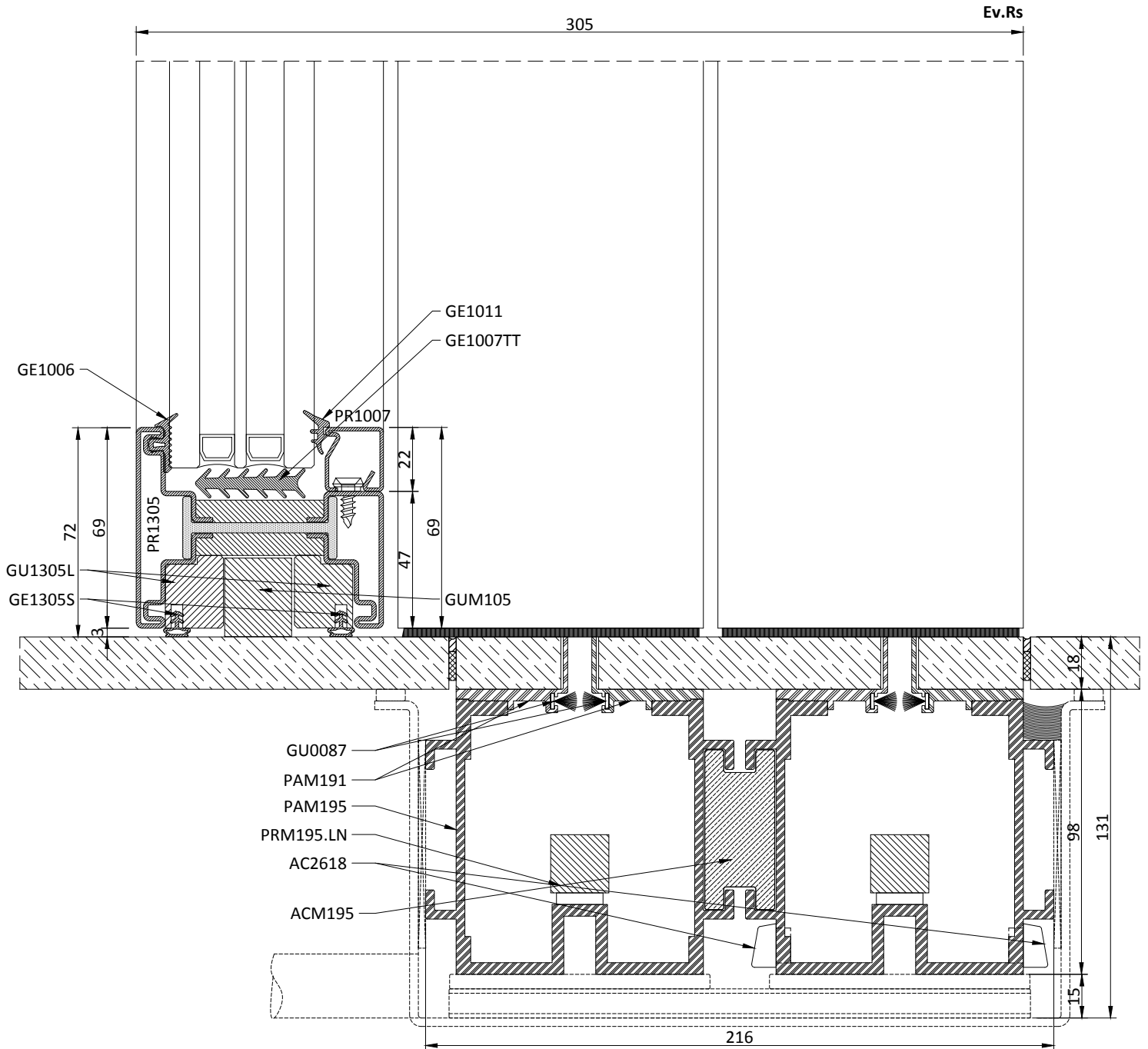
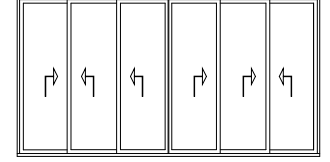

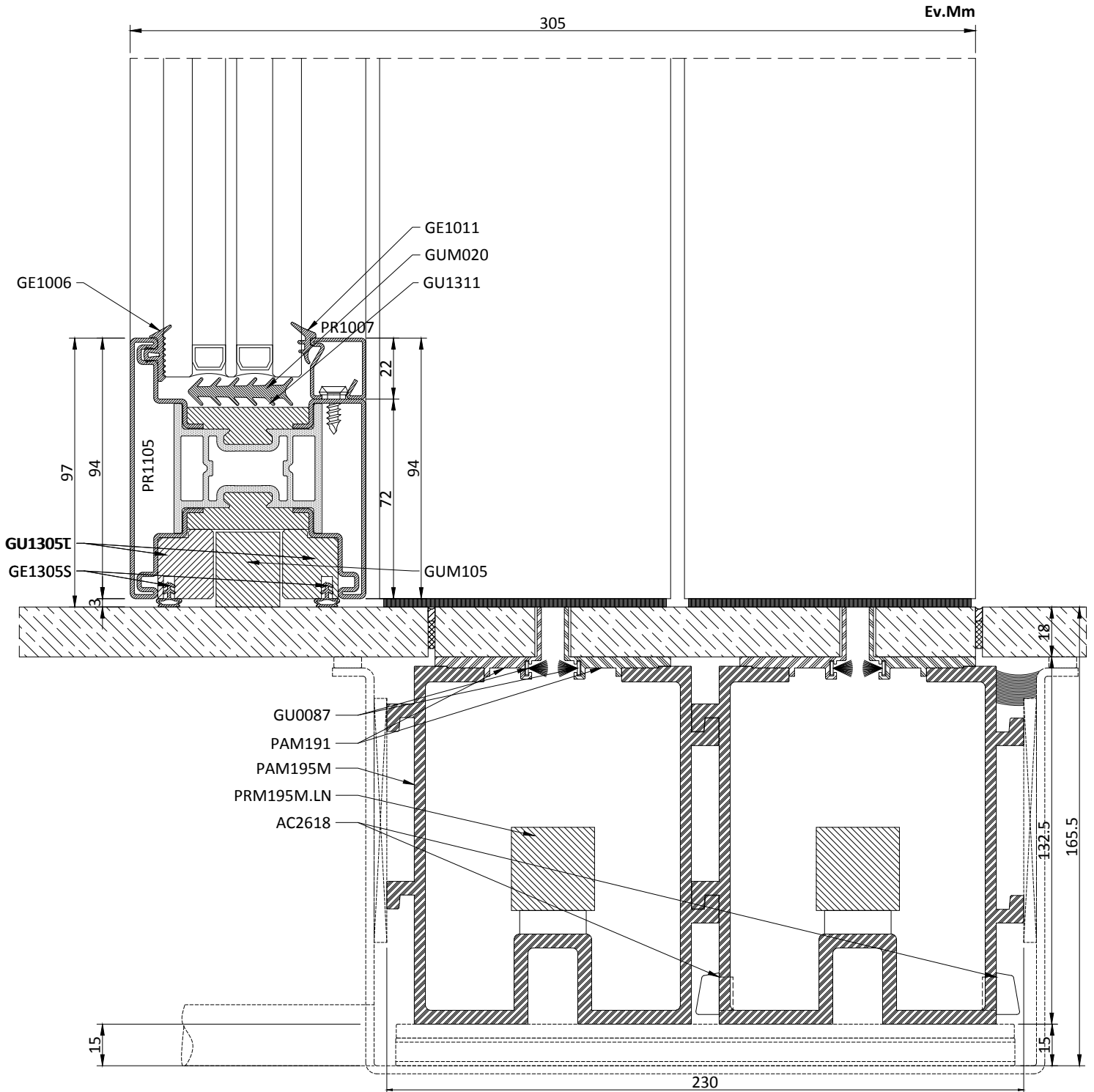
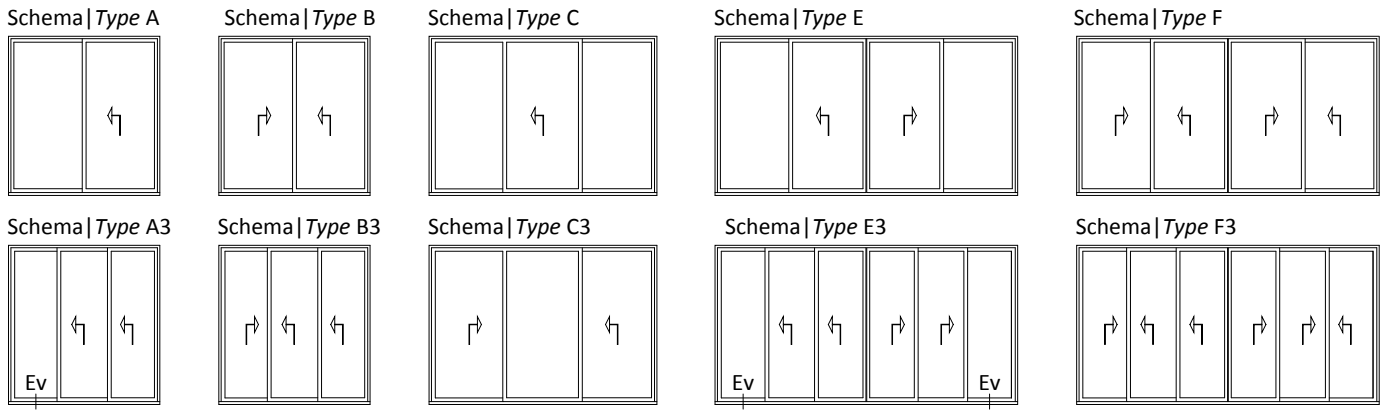

Schema | Type A

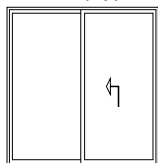

Schema | Type B

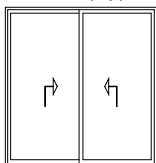

Schema | Type C

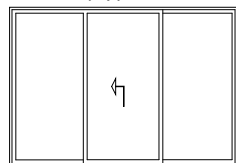

Schema | Type E

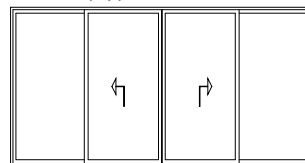

Schema | Type F

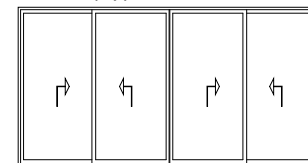

Schema | Type A3

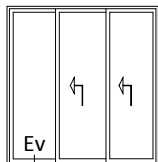

Schema | Type B3

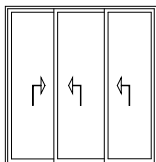

Schema | Type C3

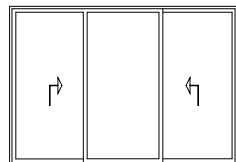

Schema | Type E3

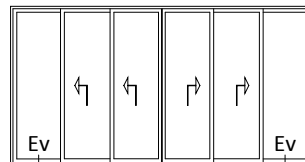

Schema | Type F3

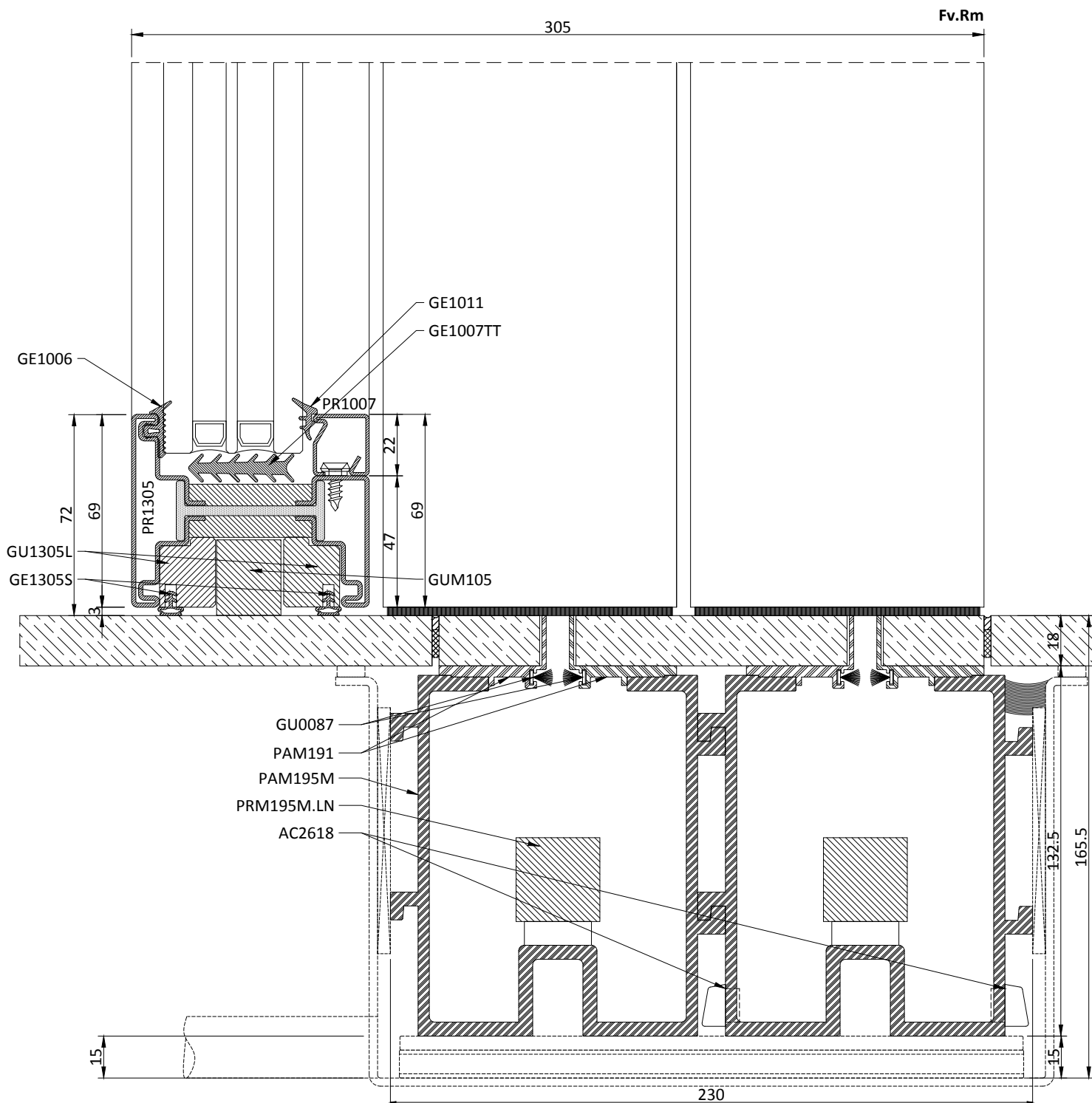
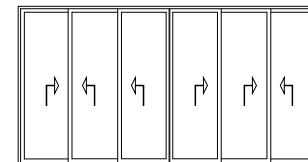

Schema | Type A

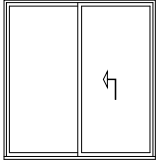

Schema | Type B

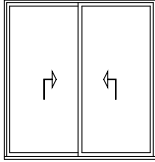

Schema | Type C

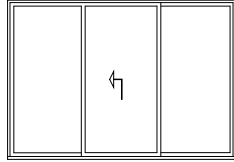

Schema | Type E

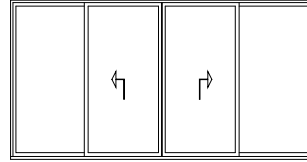

Schema | Type F

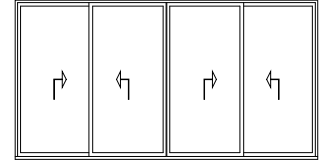

Schema | Type A3

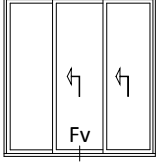

Schema | Type B3

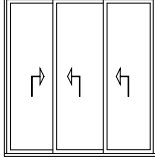

Schema | Type C3

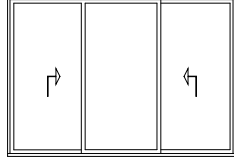

Schema | Type E3

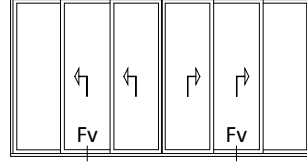

Schema | Type F3

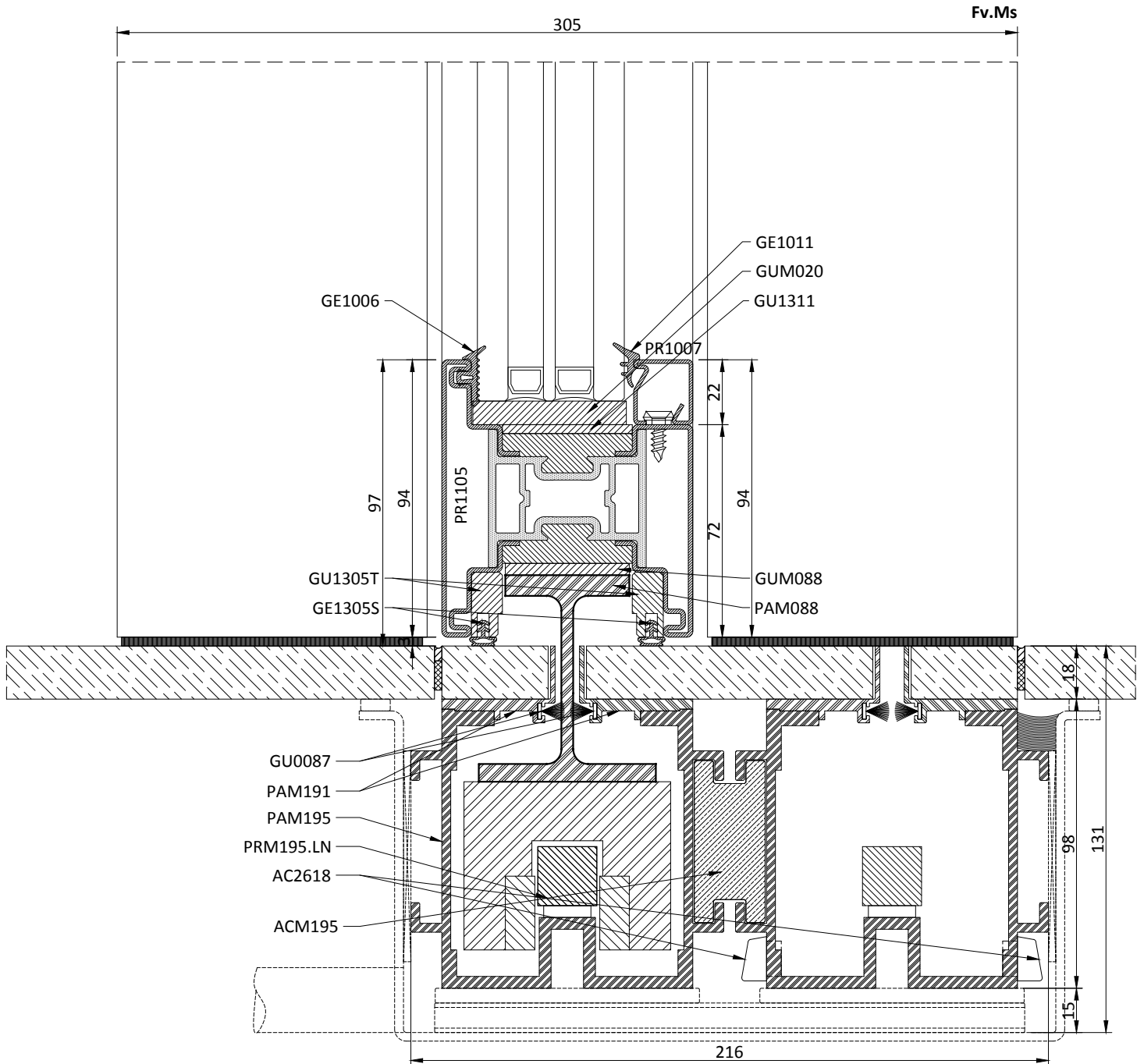
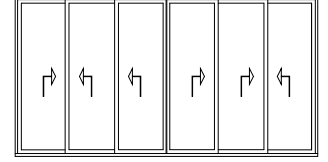

Schema | Type A

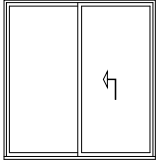

Schema | Type B

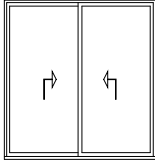

Schema | Type C

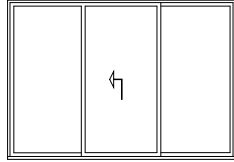

Schema | Type E

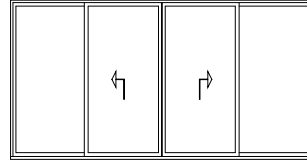

Schema | Type F

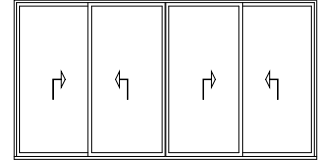

Schema | Type A3

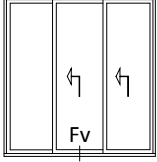

Schema | Type B3

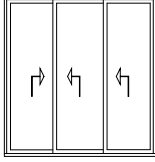

Schema | Type C3

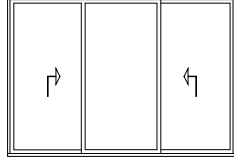

Schema | Type E3

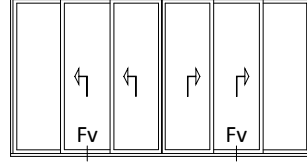

Schema | Type F3

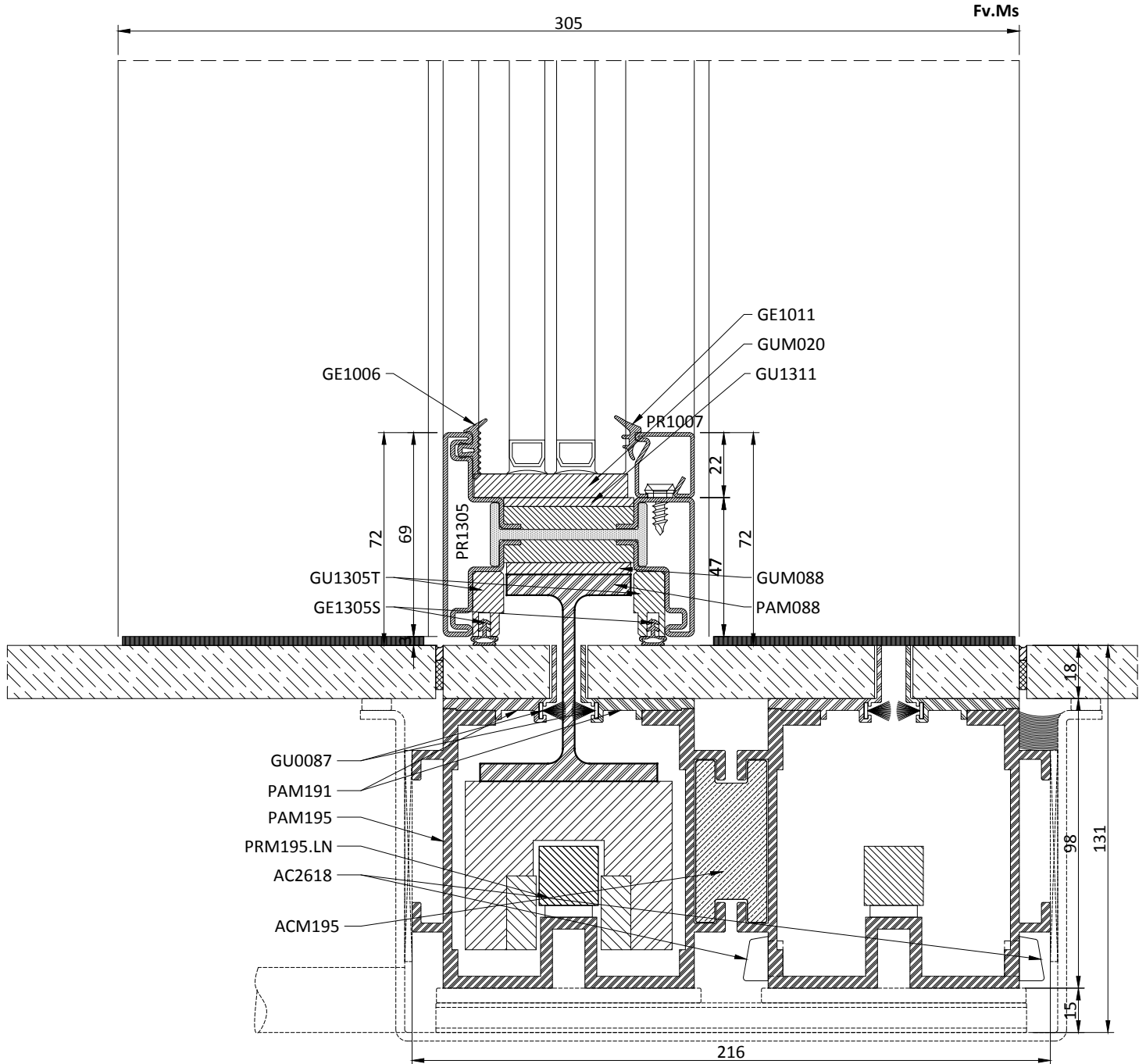
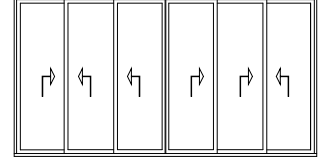



Schema | Type A

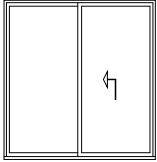

Schema | Type B

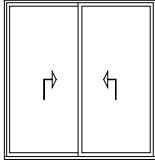

Schema | Type C

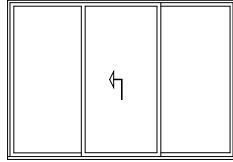

Schema | Type E

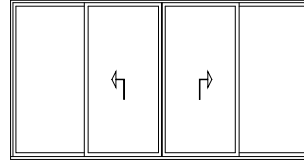

Schema | Type F

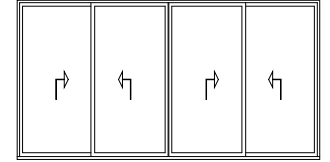

Schema | Type A3

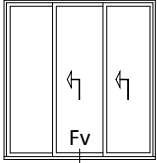

Schema | Type B3

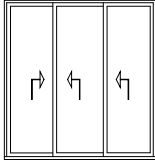

Schema | Type C3

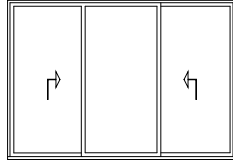

Schema | Type E3

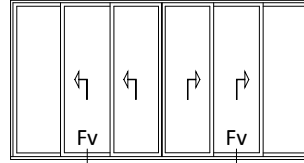

Schema | Type F3

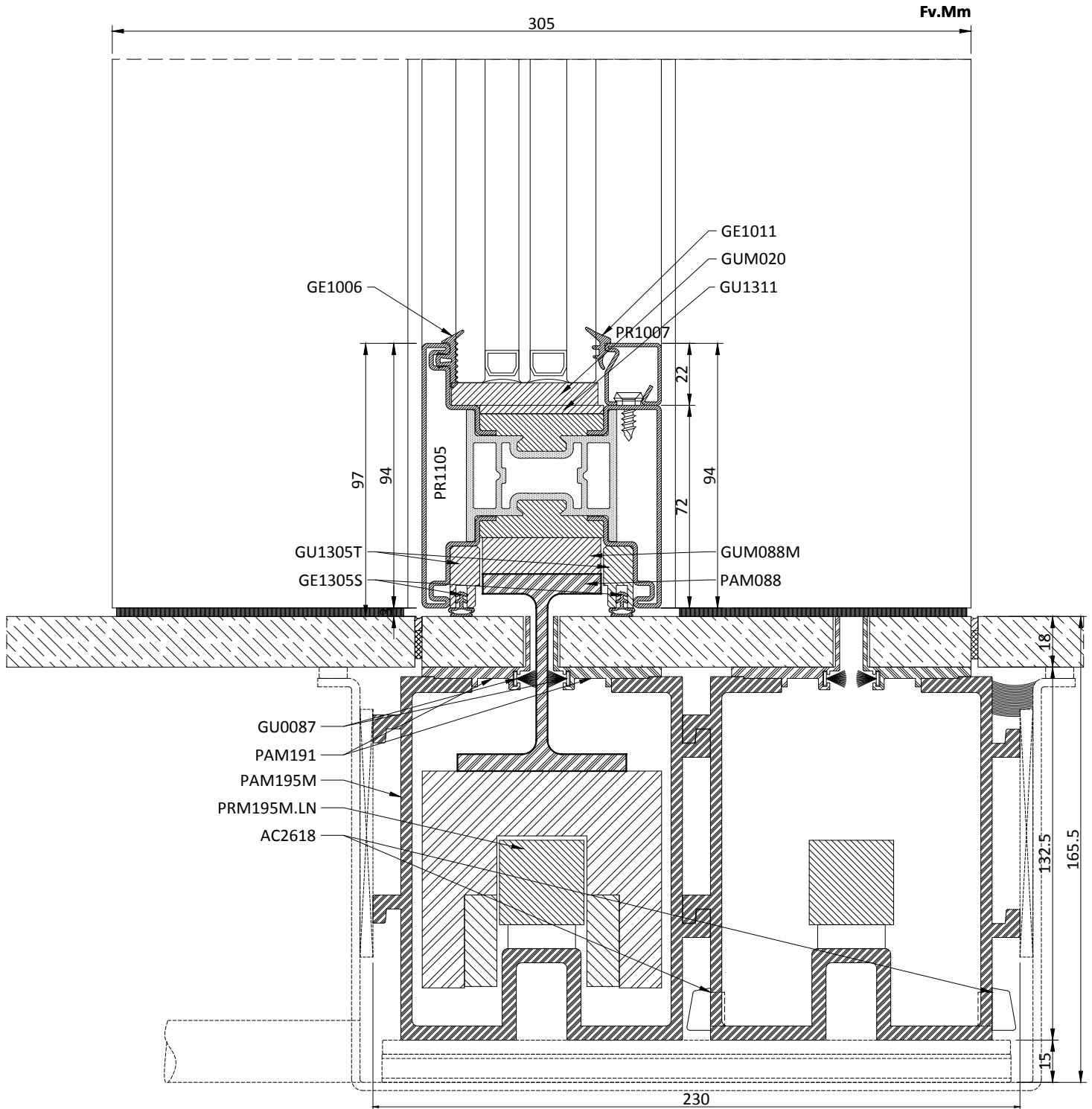
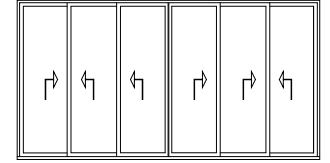

Schema | Type A

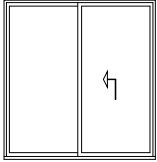

Schema | Type B

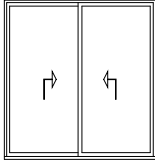

Schema | Type C

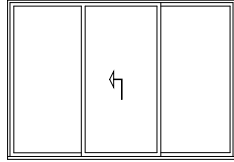

Schema | Type E

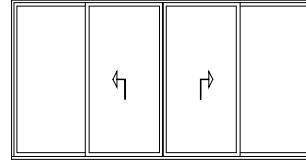

Schema | Type F

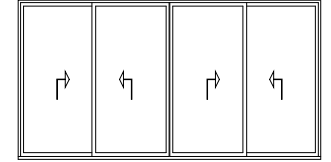

Schema | Type A3

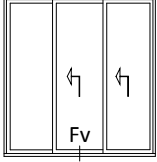

Schema | Type B3

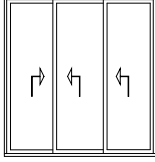

Schema | Type C3

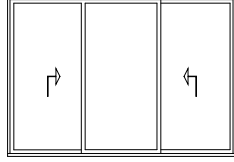

Schema | Type E3

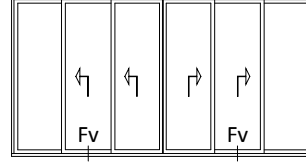

Schema | Type F3

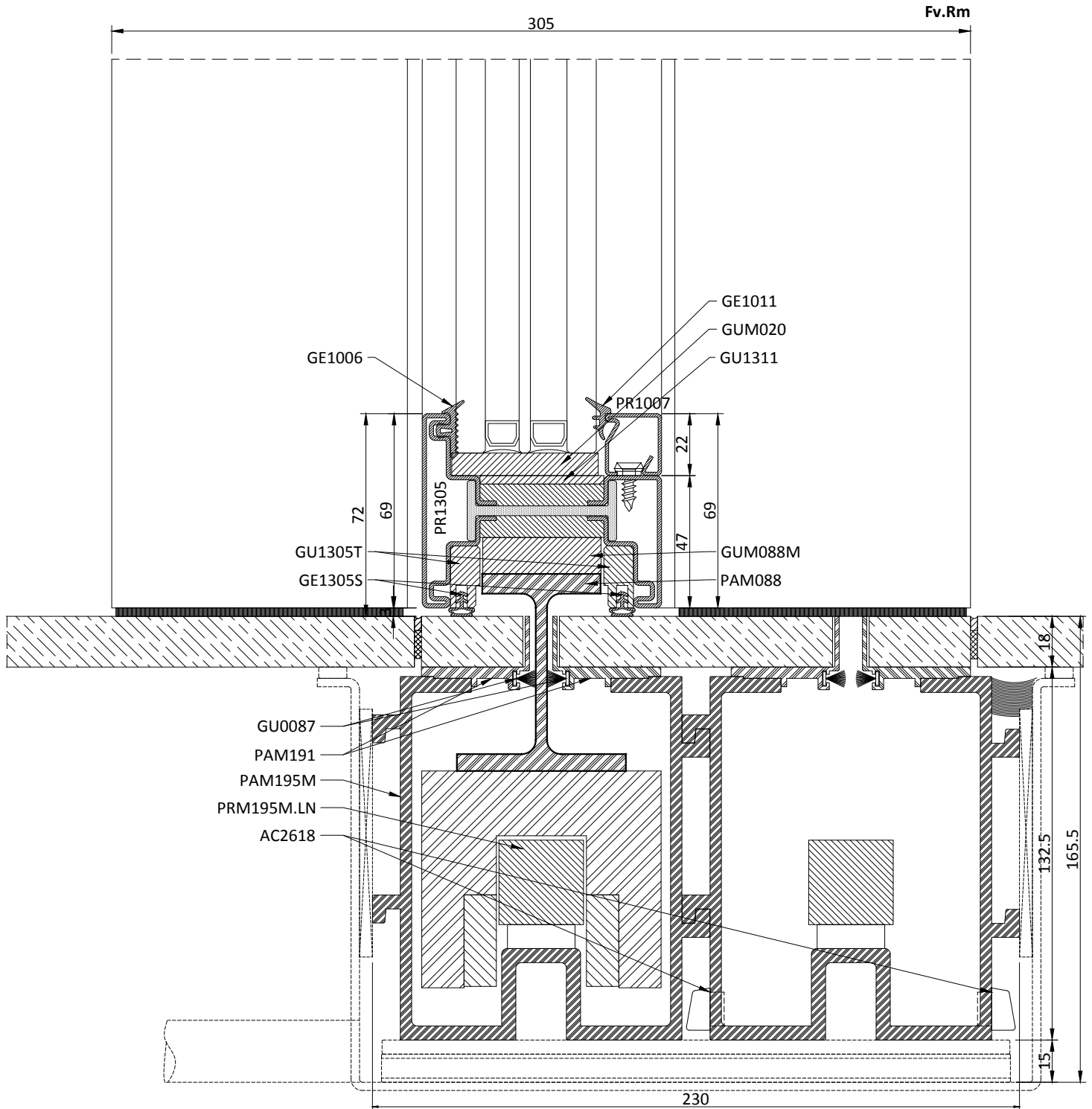
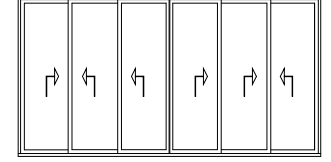

Schema | Type A

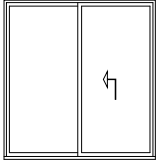

Schema | Type B

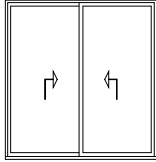

Schema | Type C

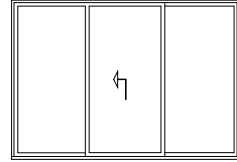

Schema | Type E

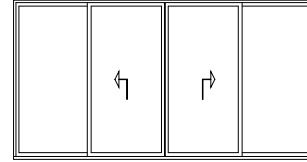

Schema | Type F

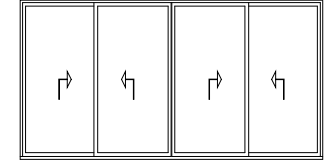

Schema | Type A3

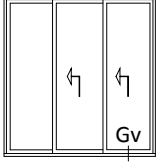

Schema | Type B3

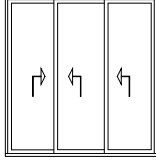

Schema | Type C3

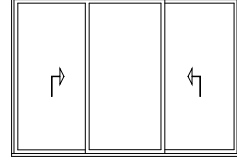

Schema | Type E3

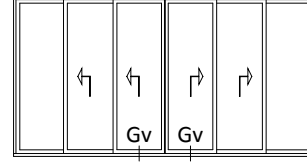

Schema | Type F3

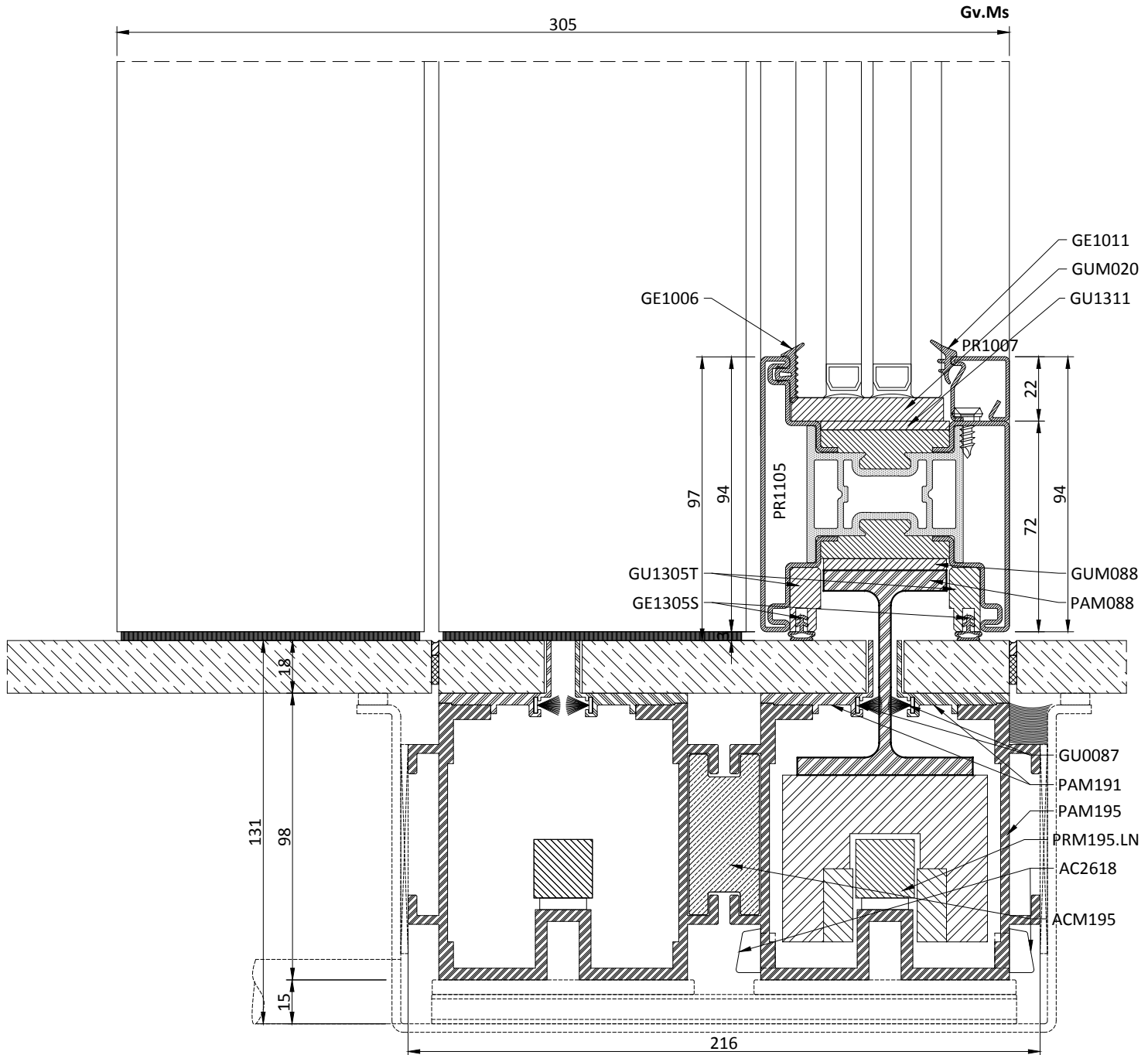
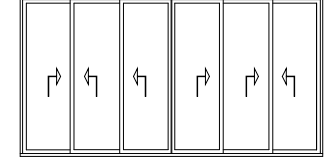

Schema | Type A

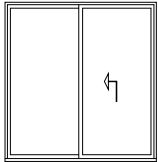

Schema | Type B

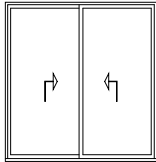

Schema | Type C

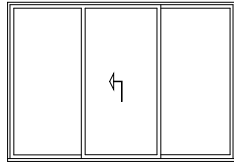

Schema | Type E

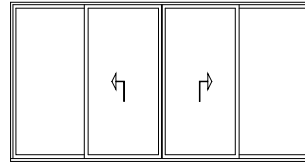

Schema | Type F

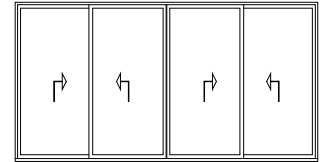

Schema | Type A3

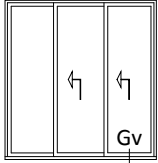

Schema | Type B3

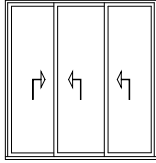

Schema | Type C3

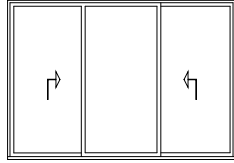

Schema | Type E3

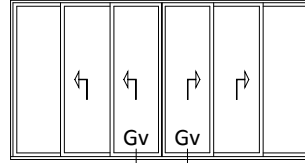

Schema | Type F3

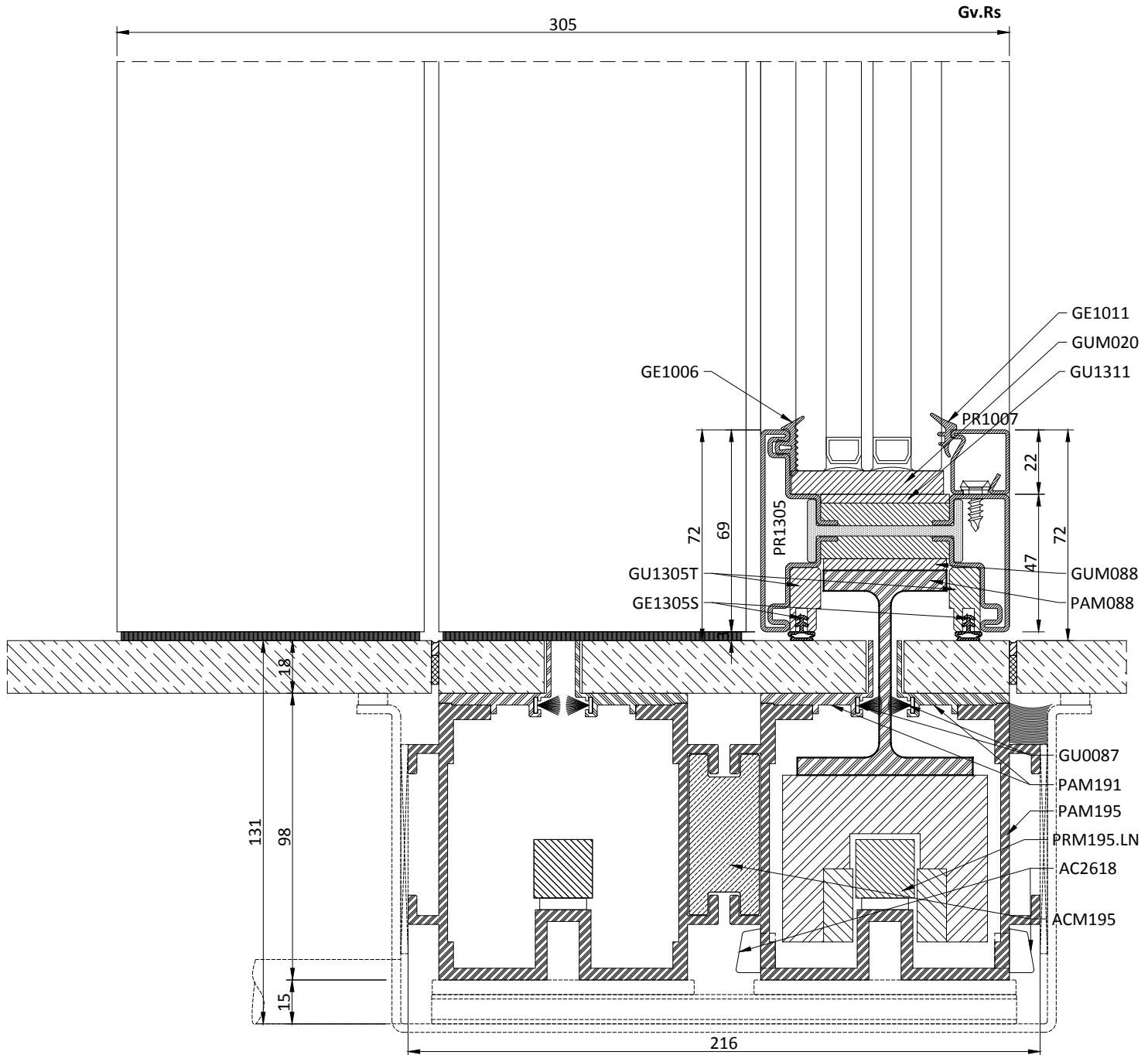
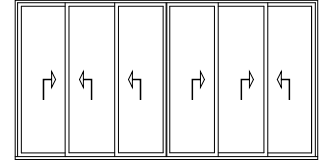

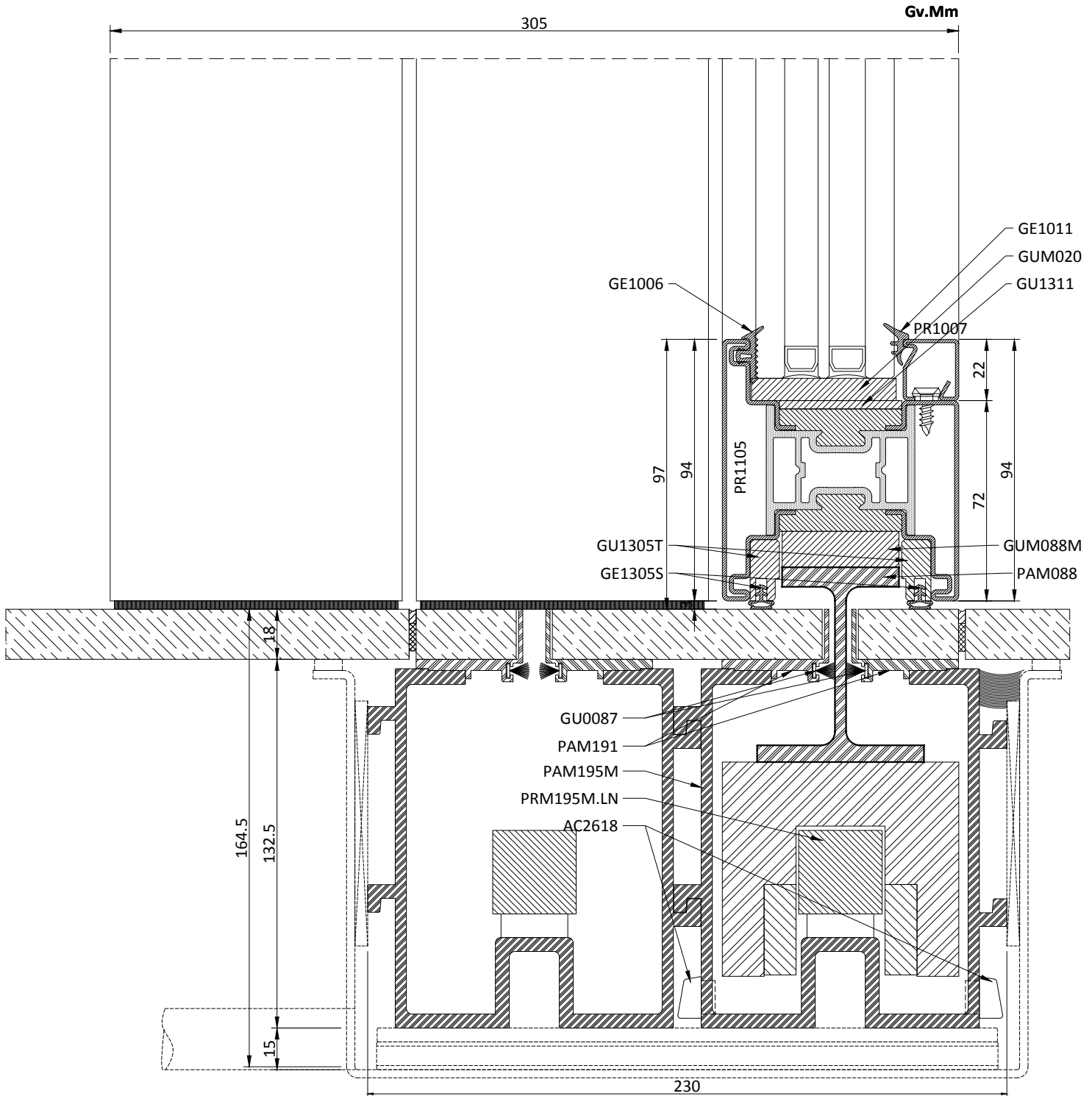
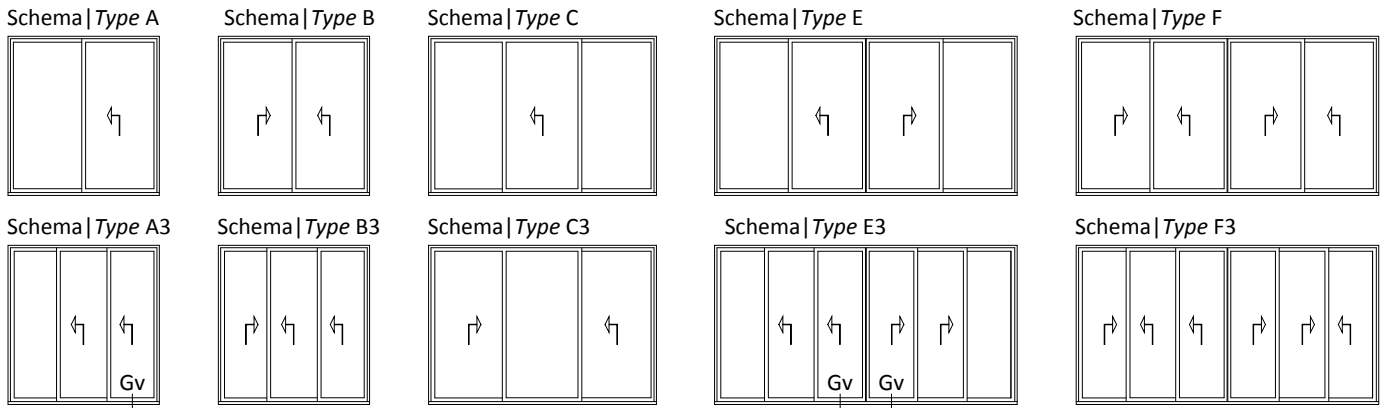

Schema | Type A

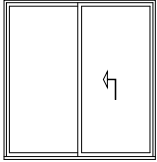

Schema | Type B

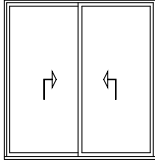

Schema | Type C

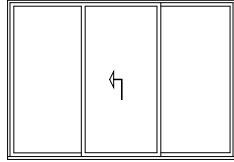

Schema | Type E

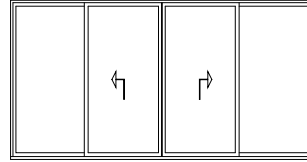

Schema | Type F

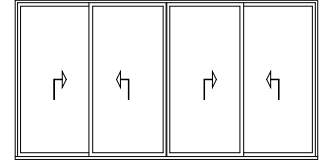

Schema | Type A3

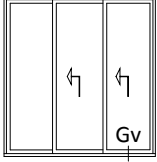

Schema | Type B3

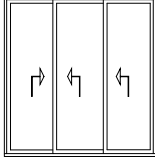

Schema | Type C3

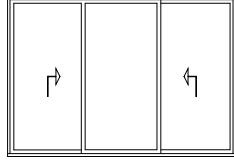

Schema | Type E3

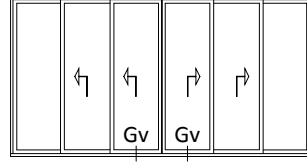

Schema | Type F3

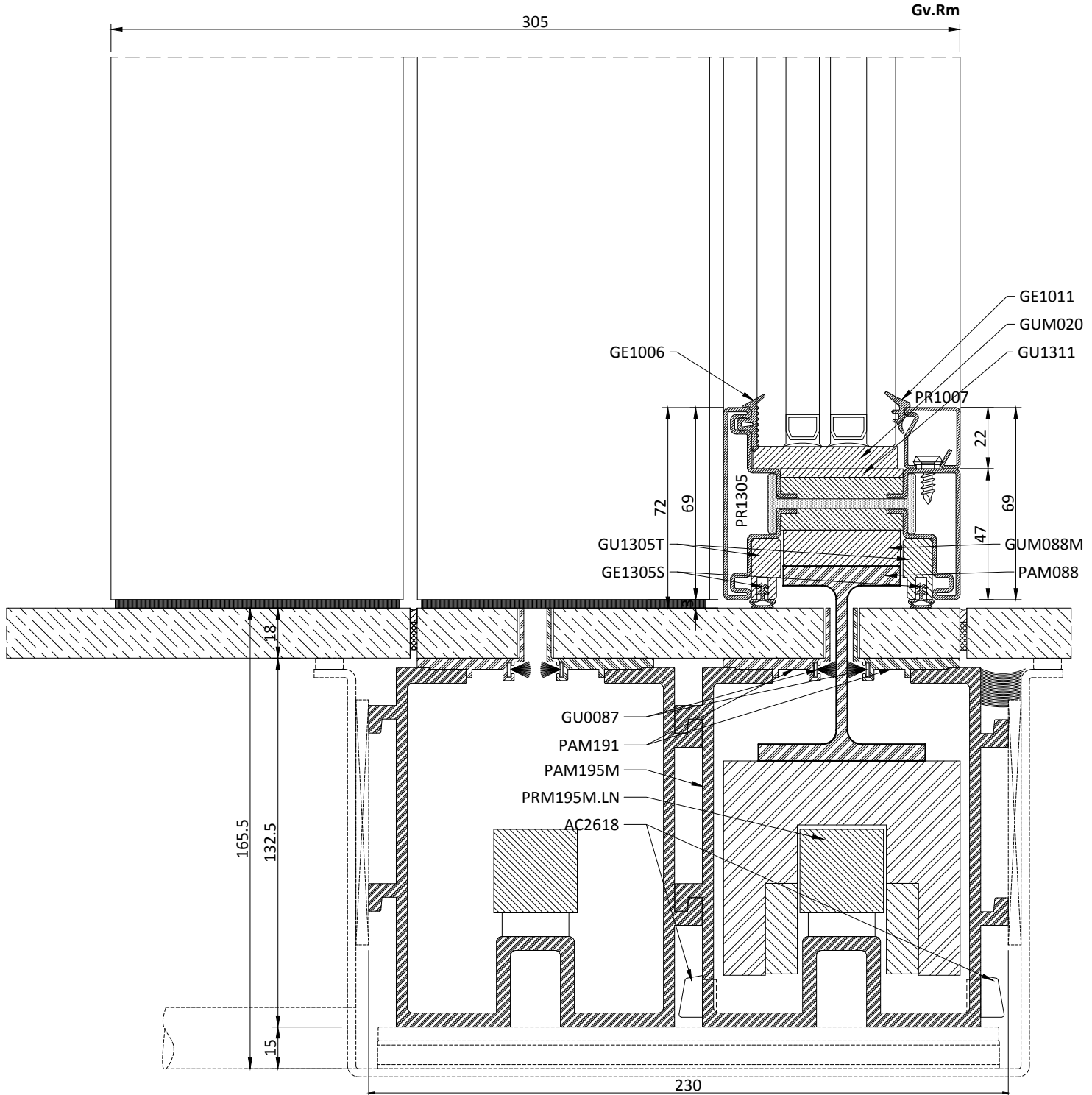
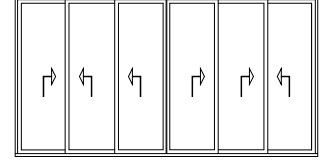

Schema | Type A

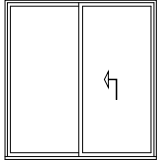

Schema | Type B

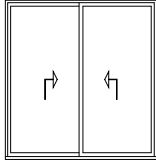

Schema | Type C

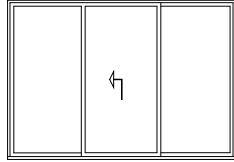

Schema | Type E

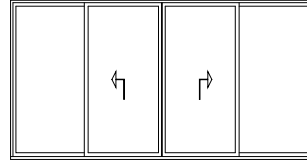

Schema | Type F

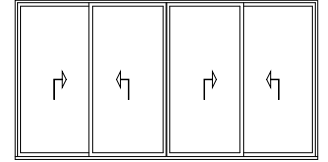

Schema | Type A3

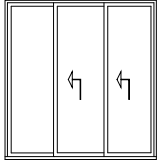

Schema | Type B3

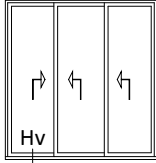

Schema | Type C3

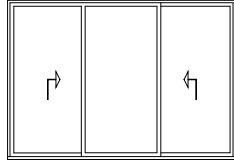

Schema | Type E3

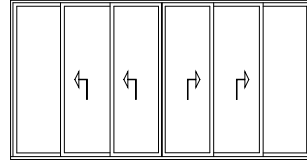

Schema | Type F3

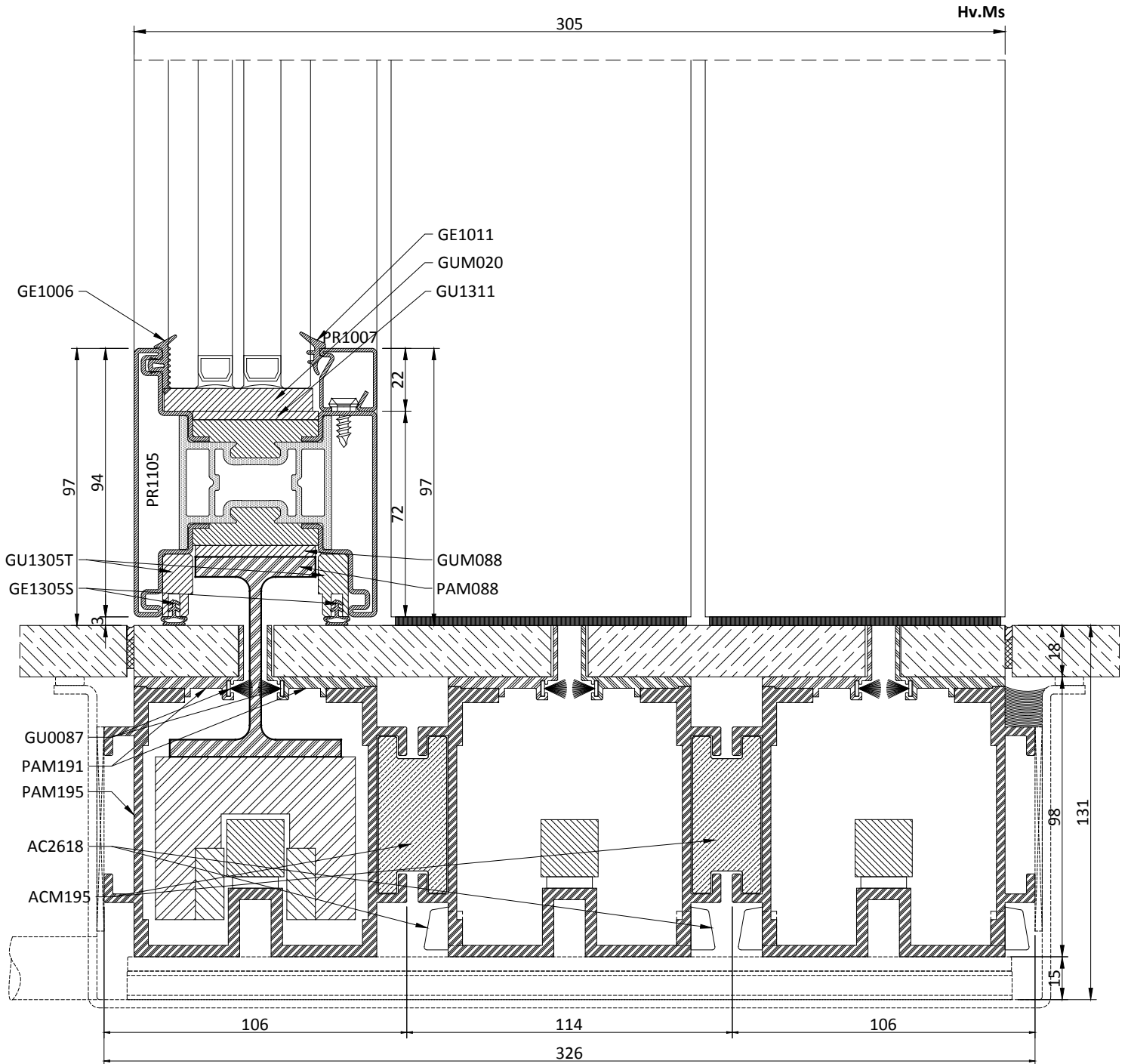
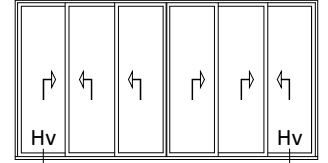

Schema | Type A

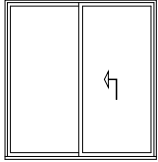

Schema | Type B

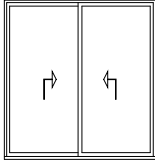

Schema | Type C

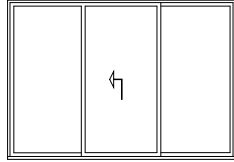

Schema | Type E

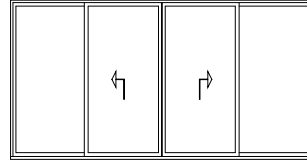

Schema | Type F

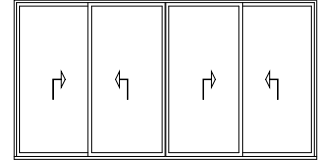

Schema | Type A3

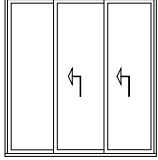

Schema | Type B3

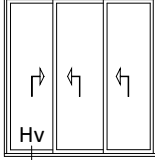

Schema | Type C3

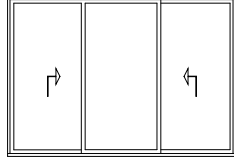

Schema | Type E3

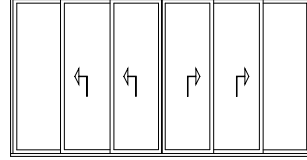

Schema | Type F3

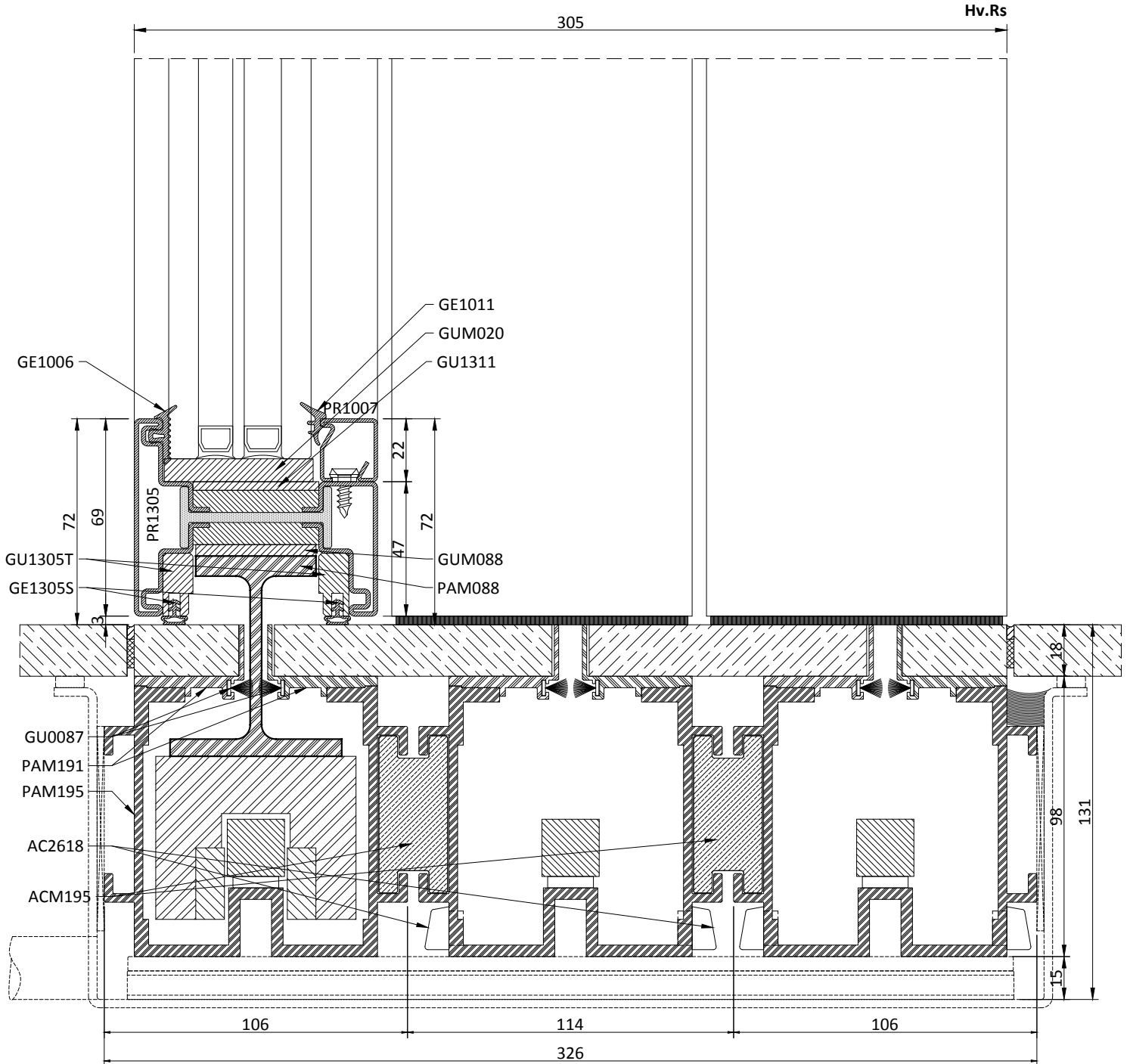
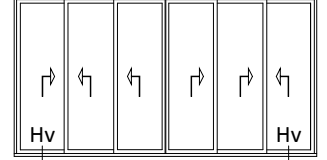



Schema | Type A

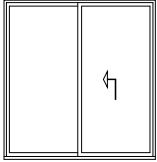

Schema | Type B

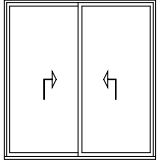

Schema | Type C

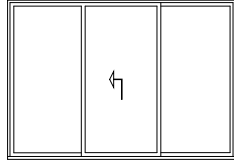

Schema | Type E

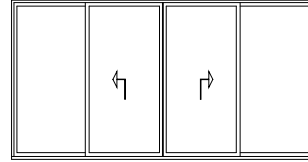

Schema | Type F

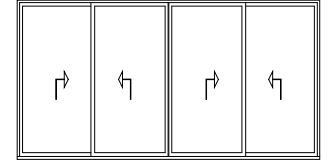

Schema | Type A3

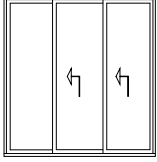

Schema | Type B3

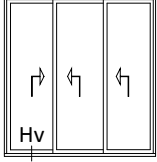

Schema | Type C3

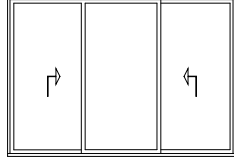

Schema | Type E3

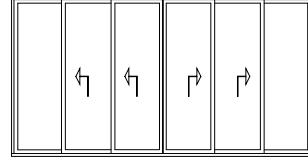

Schema | Type F3

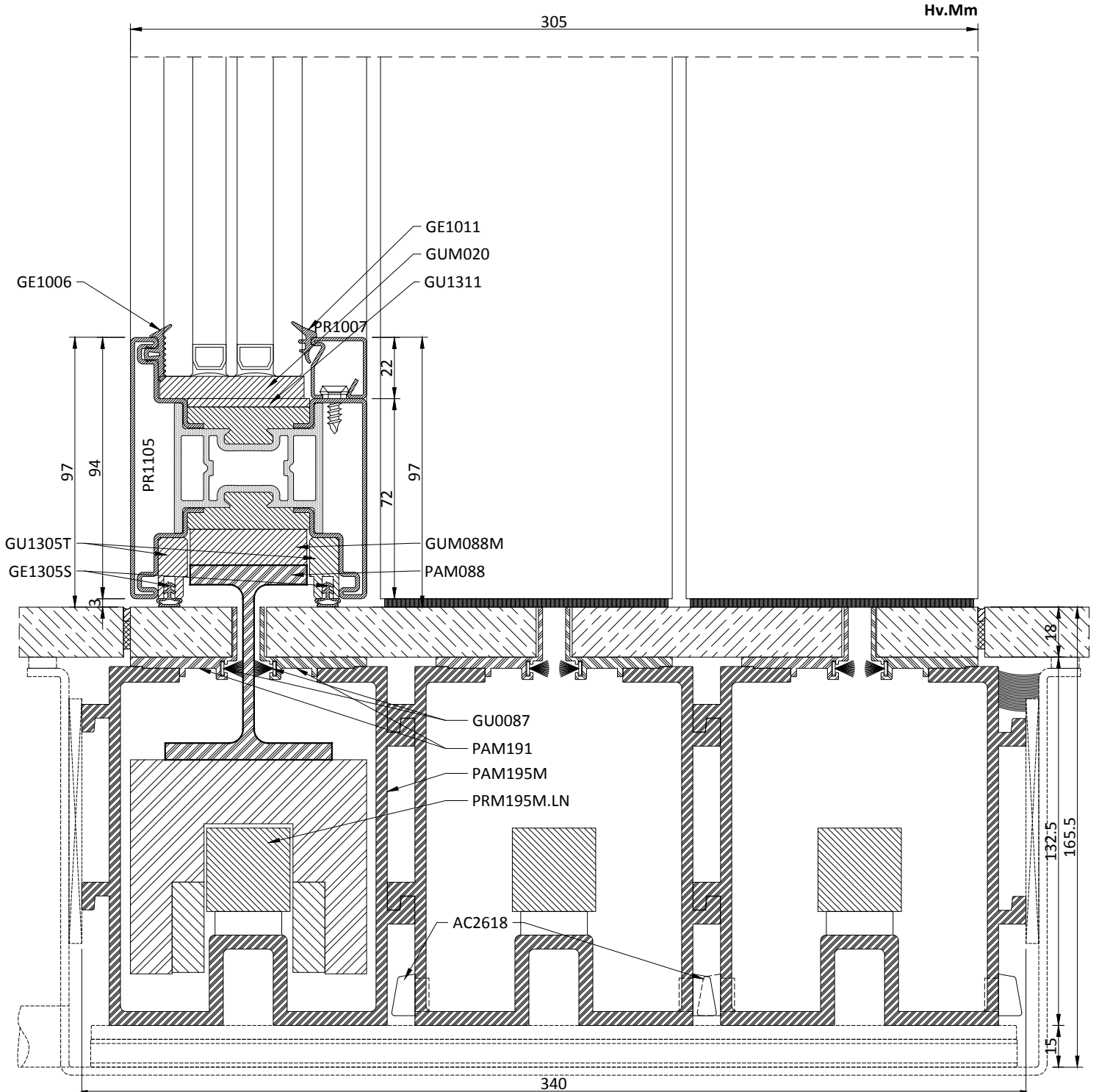
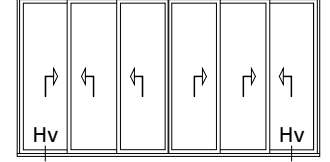

Schema | Type A

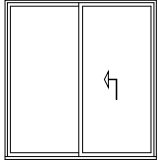

Schema | Type B

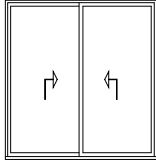

Schema | Type C

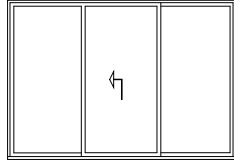

Schema | Type E

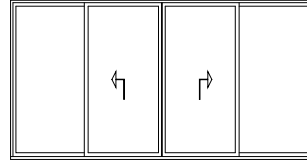

Schema | Type F

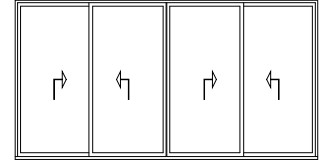

Schema | Type A3

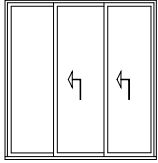

Schema | Type B3

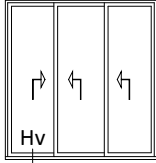

Schema | Type C3

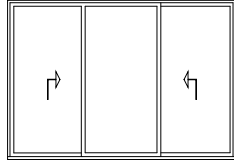

Schema | Type E3

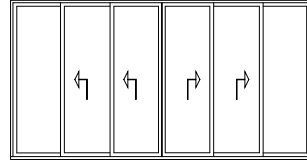

Schema | Type F3

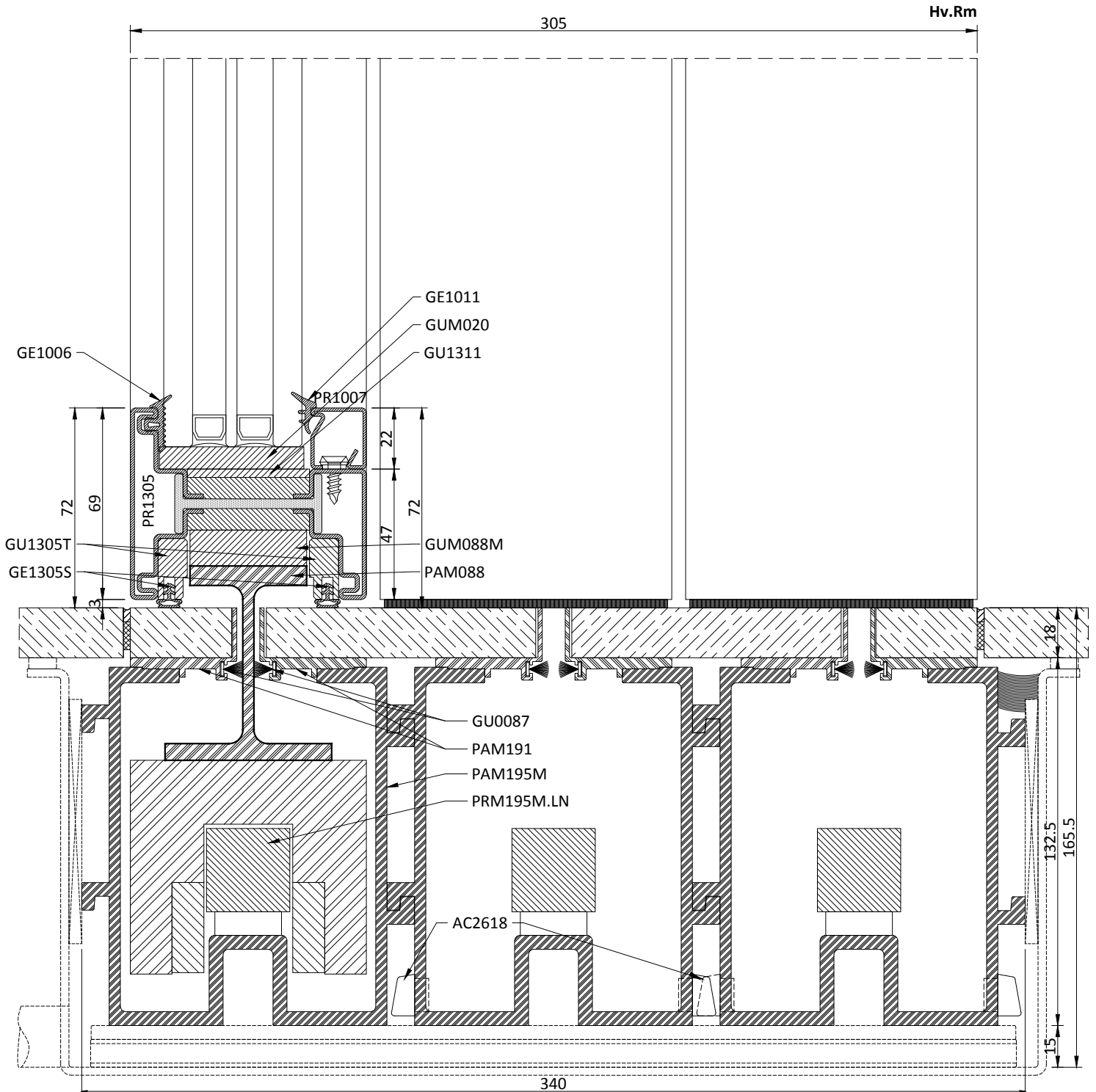
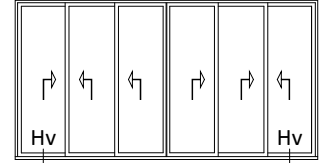

Schema | Type A

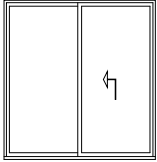

Schema | Type B

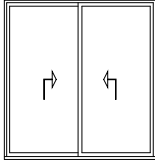

Schema | Type C

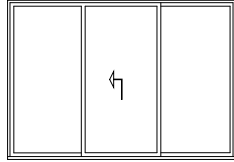

Schema | Type E

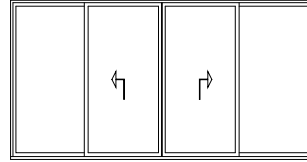

Schema | Type F

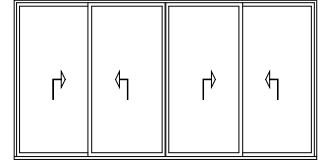

Schema | Type A3

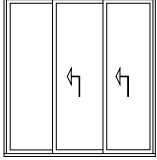

Schema | Type B3

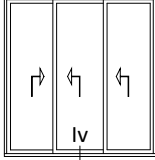

Schema | Type C3

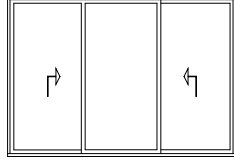

Schema | Type E3

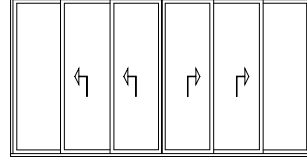

Schema | Type F3

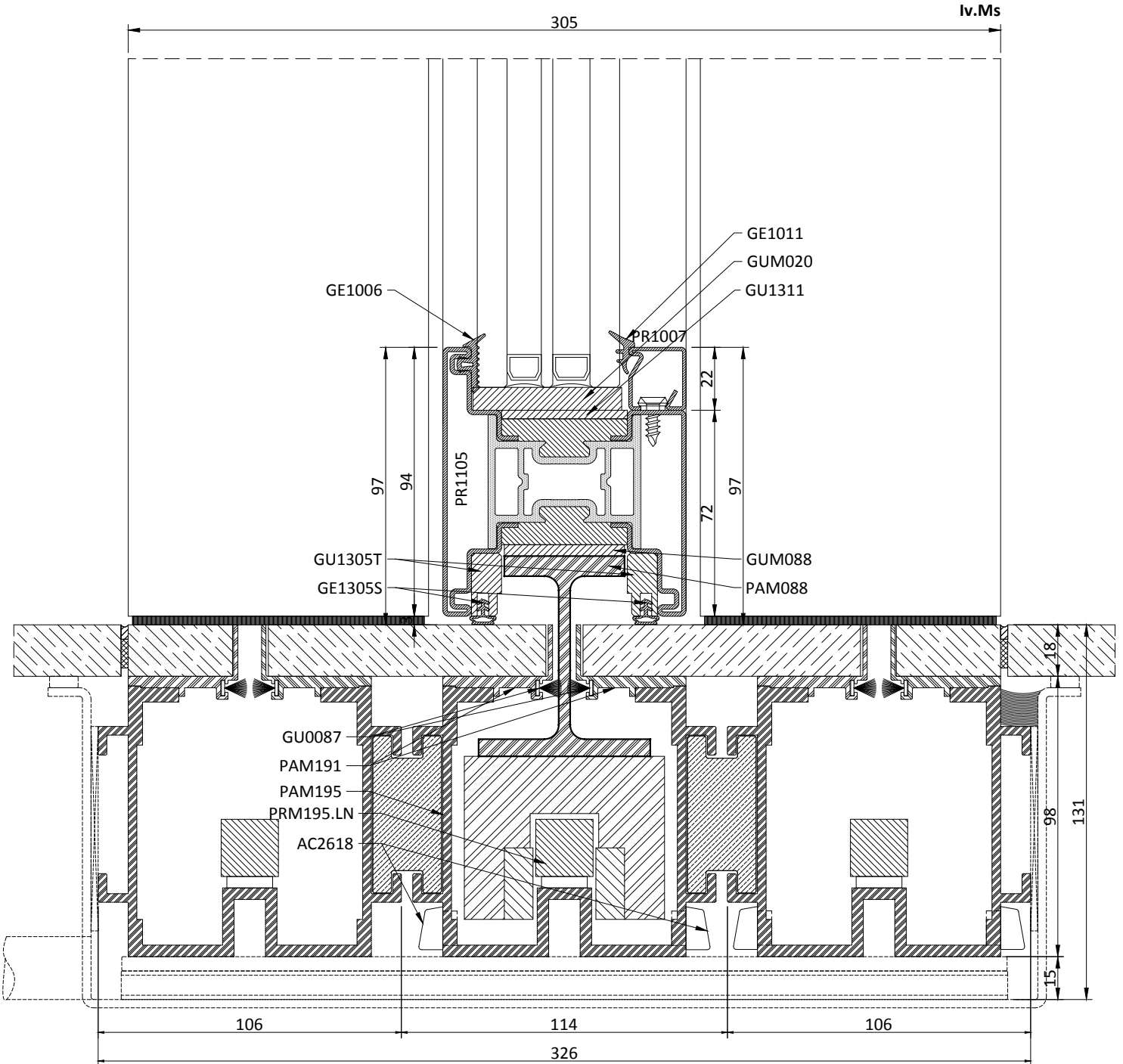
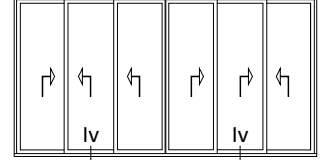

Schema | Type A

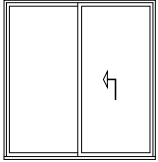

Schema | Type B

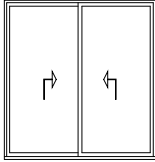

Schema | Type C

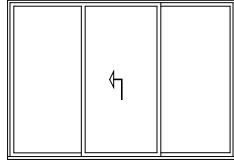

Schema | Type E

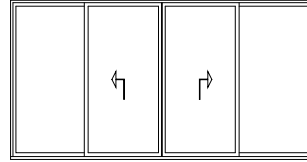

Schema | Type F

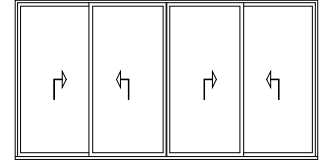

Schema | Type A3

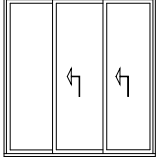

Schema | Type B3

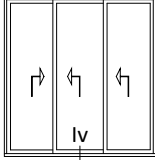

Schema | Type C3

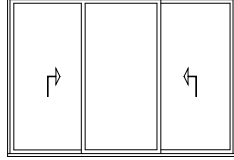

Schema | Type E3

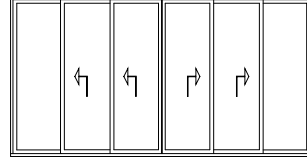

Schema | Type F3

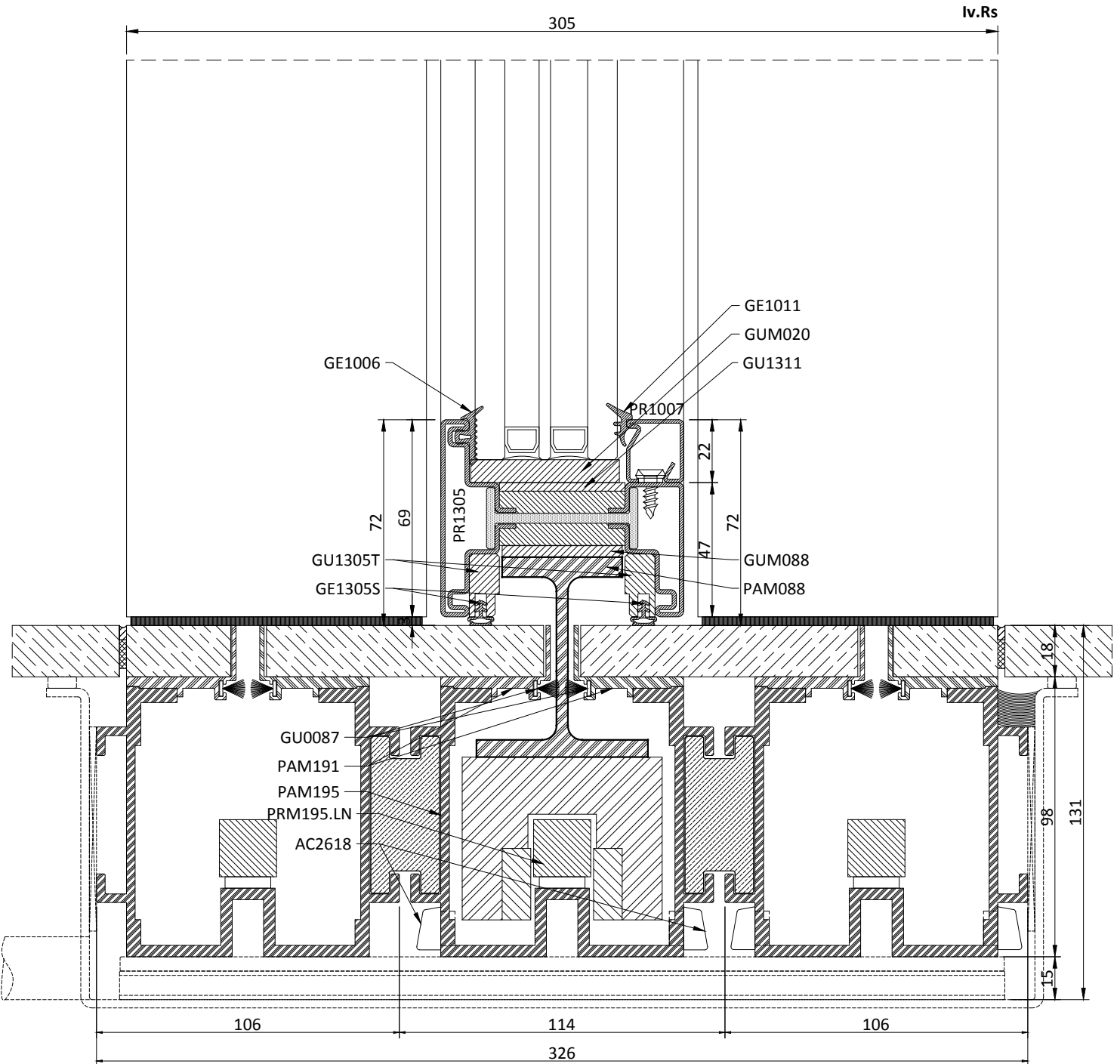
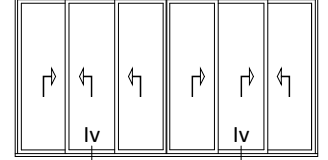

Schema | Type A

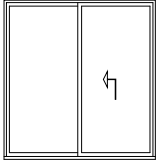

Schema | Type B

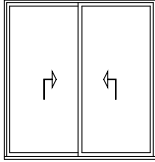

Schema | Type C

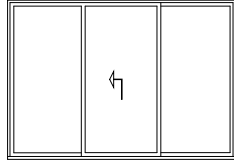

Schema | Type E

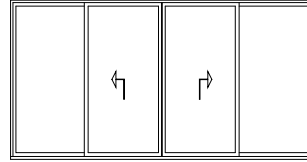

Schema | Type F

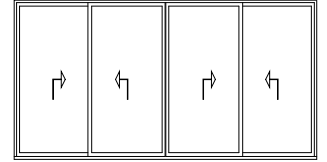

Schema | Type A3

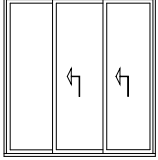

Schema | Type B3

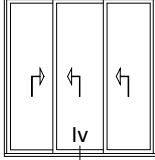

Schema | Type C3

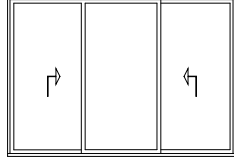

Schema | Type E3

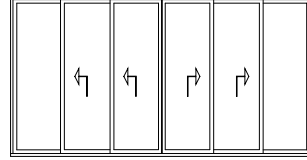

Schema | Type F3

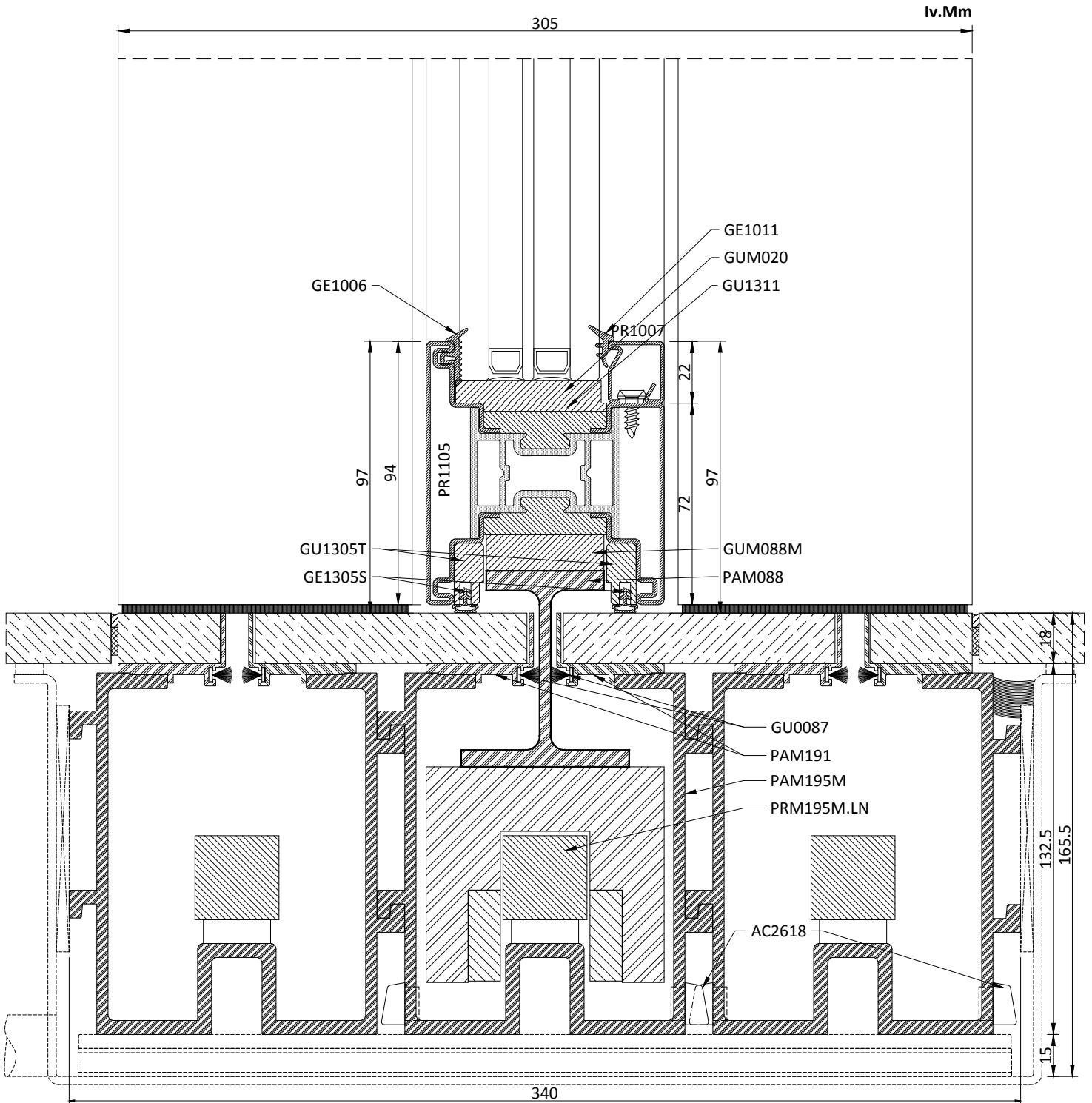
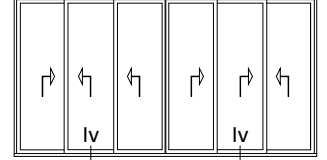

Schema | Type A

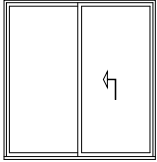

Schema | Type B

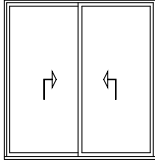

Schema | Type C

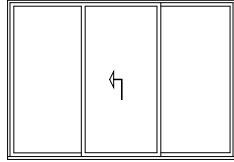

Schema | Type E

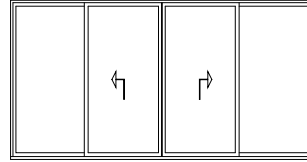

Schema | Type F

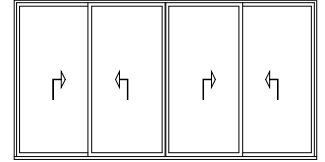

Schema | Type A3

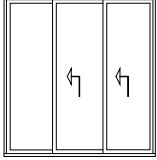

Schema | Type B3

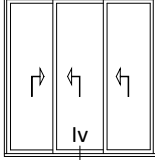

Schema | Type C3

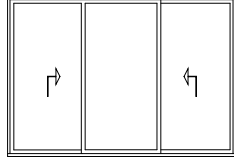

Schema | Type E3

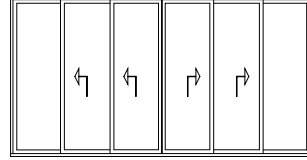

Schema | Type F3

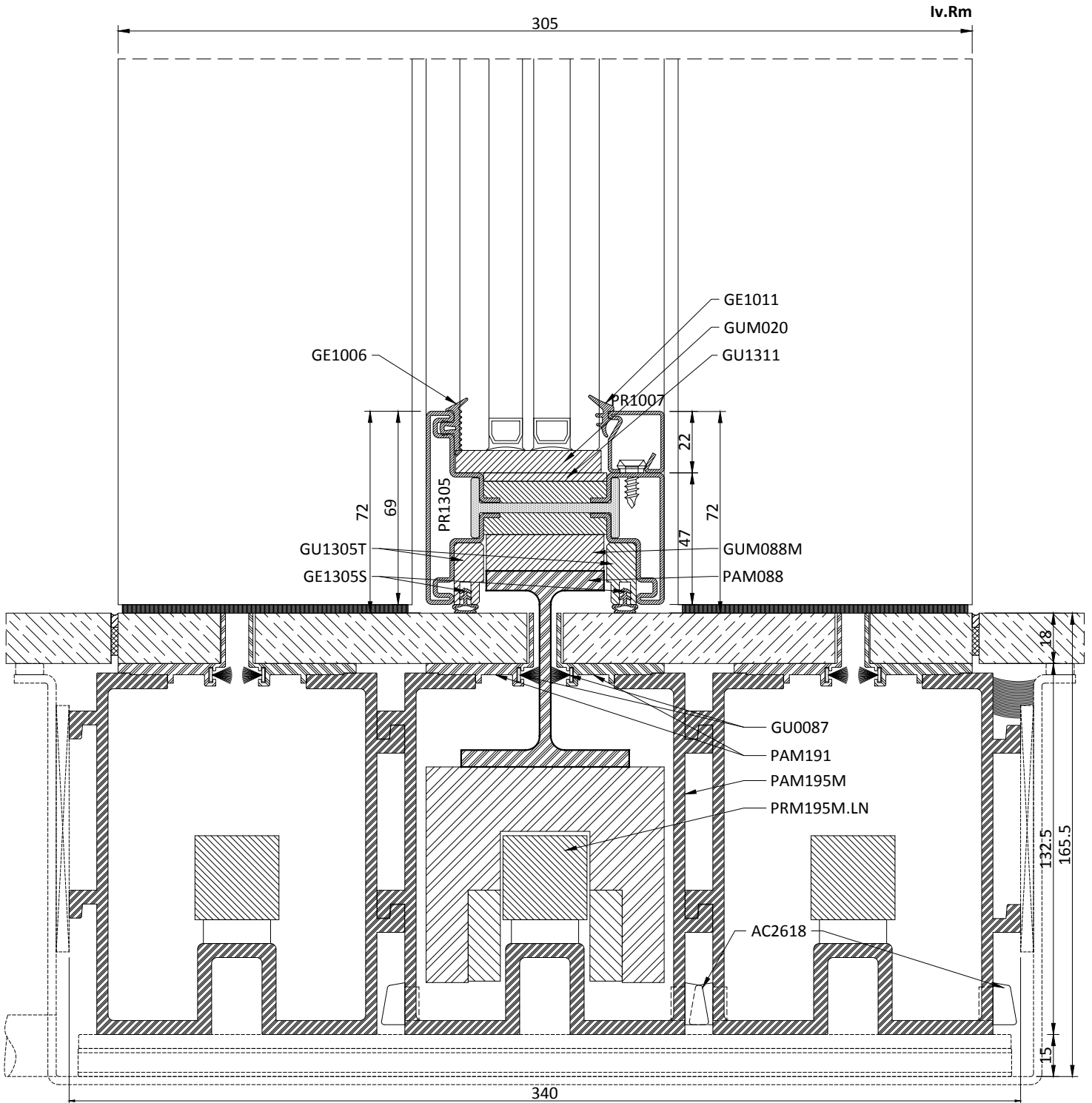
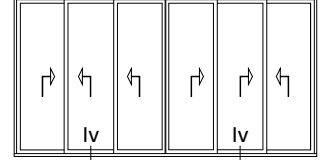

Schema | Type A

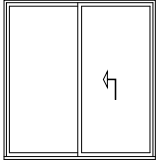

Schema | Type B

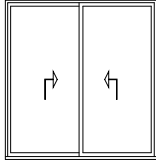

Schema | Type C

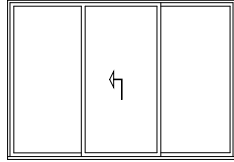

Schema | Type E

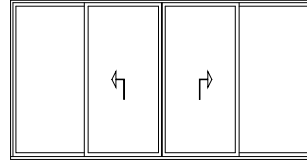

Schema | Type F

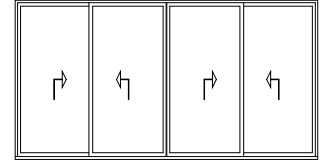

Schema | Type A3

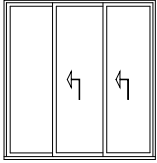

Schema | Type B3

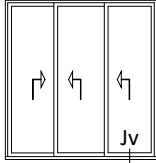

Schema | Type C3

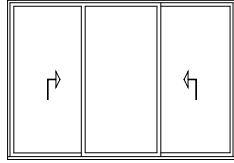

Schema | Type E3

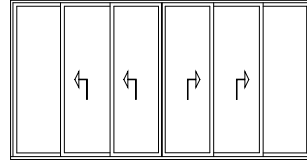

Schema | Type F3

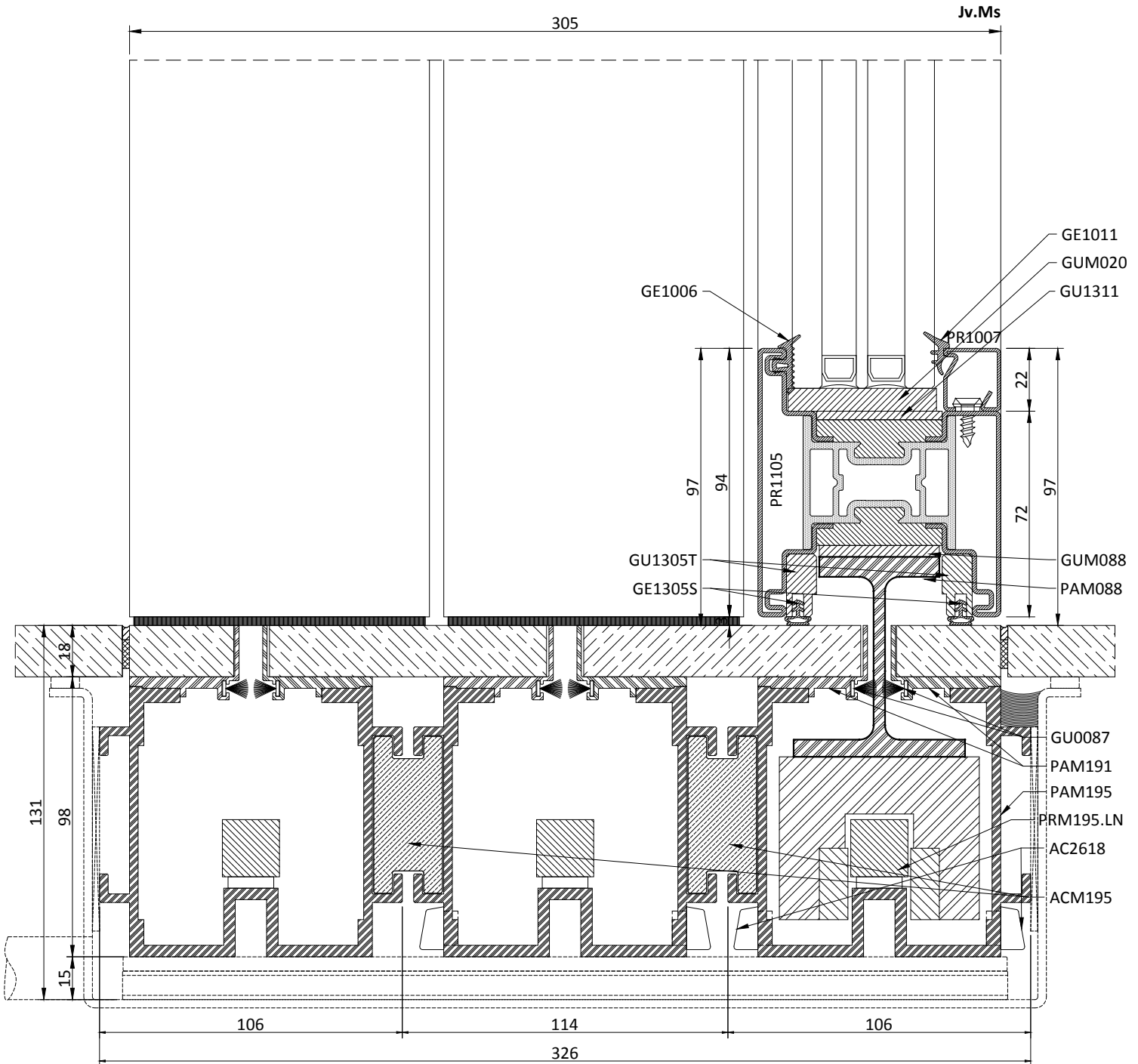
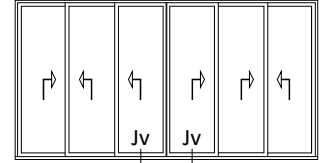

Schema | Type A

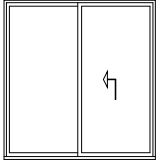

Schema | Type B

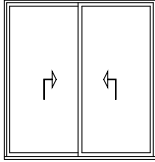

Schema | Type C

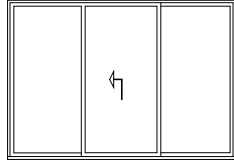

Schema | Type E

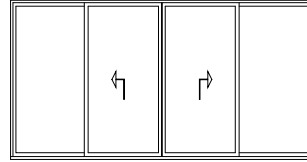

Schema | Type F

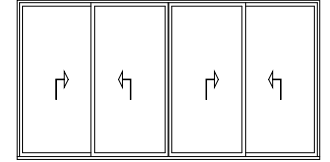

Schema | Type A3

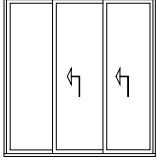

Schema | Type B3

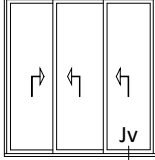

Schema | Type C3

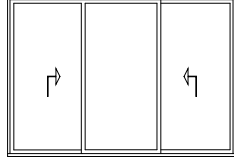

Schema | Type E3

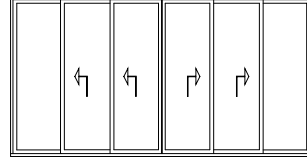

Schema | Type F3

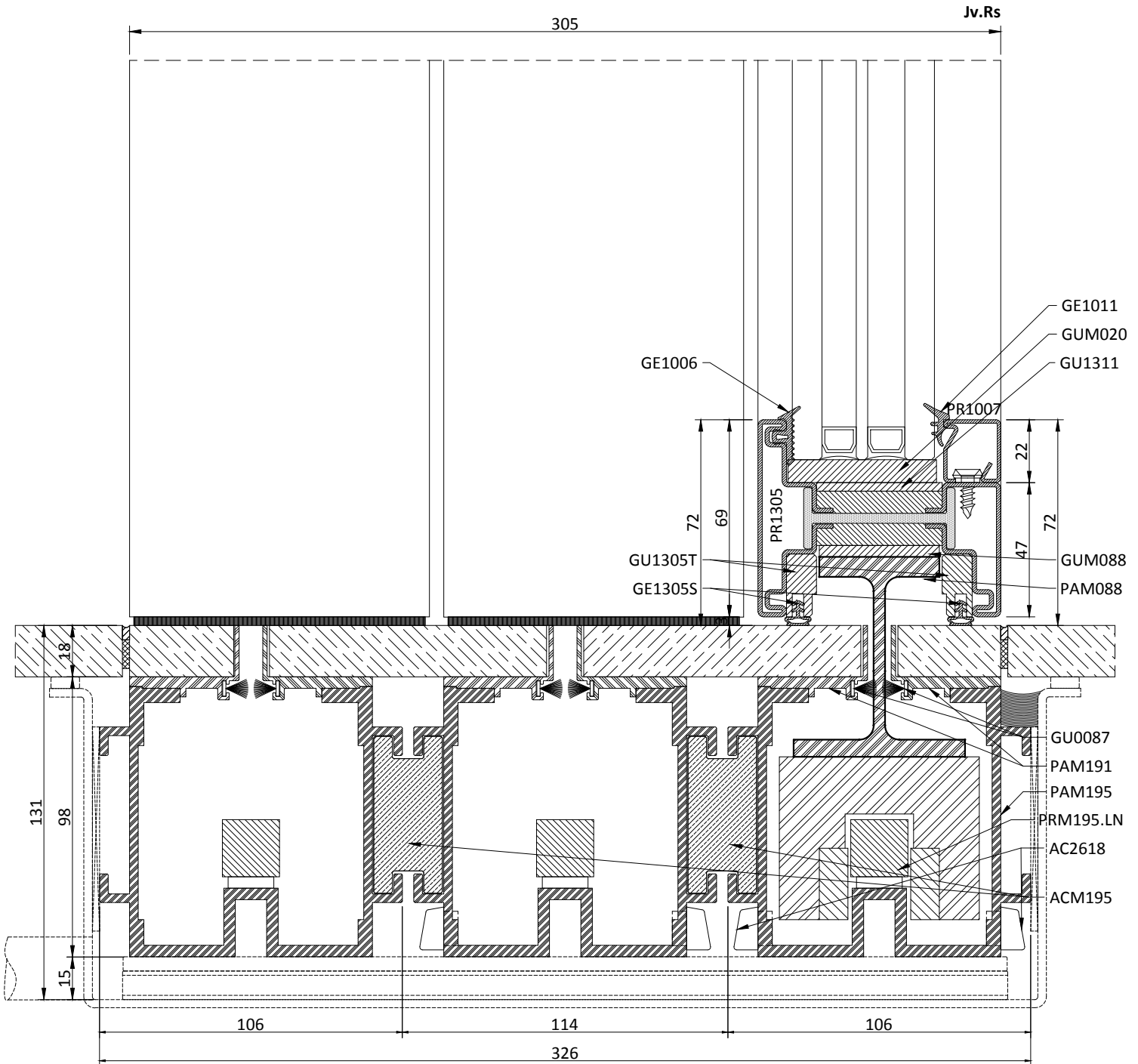
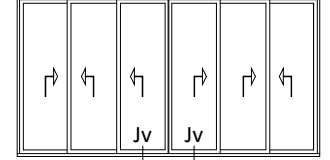



Schema | Type A

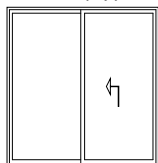

Schema | Type B

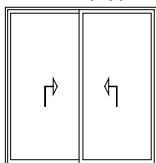

Schema | Type C

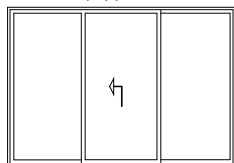

Schema | Type E

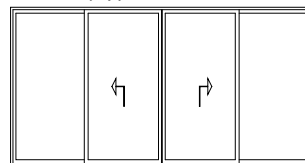

Schema | Type F

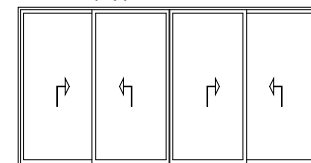

Schema | Type A3

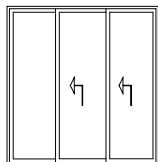

Schema | Type B3

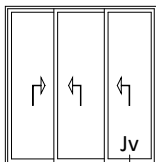

Schema | Type C3

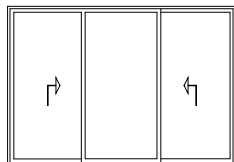

Schema | Type E3

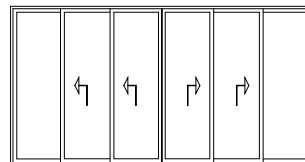

Schema | Type F3

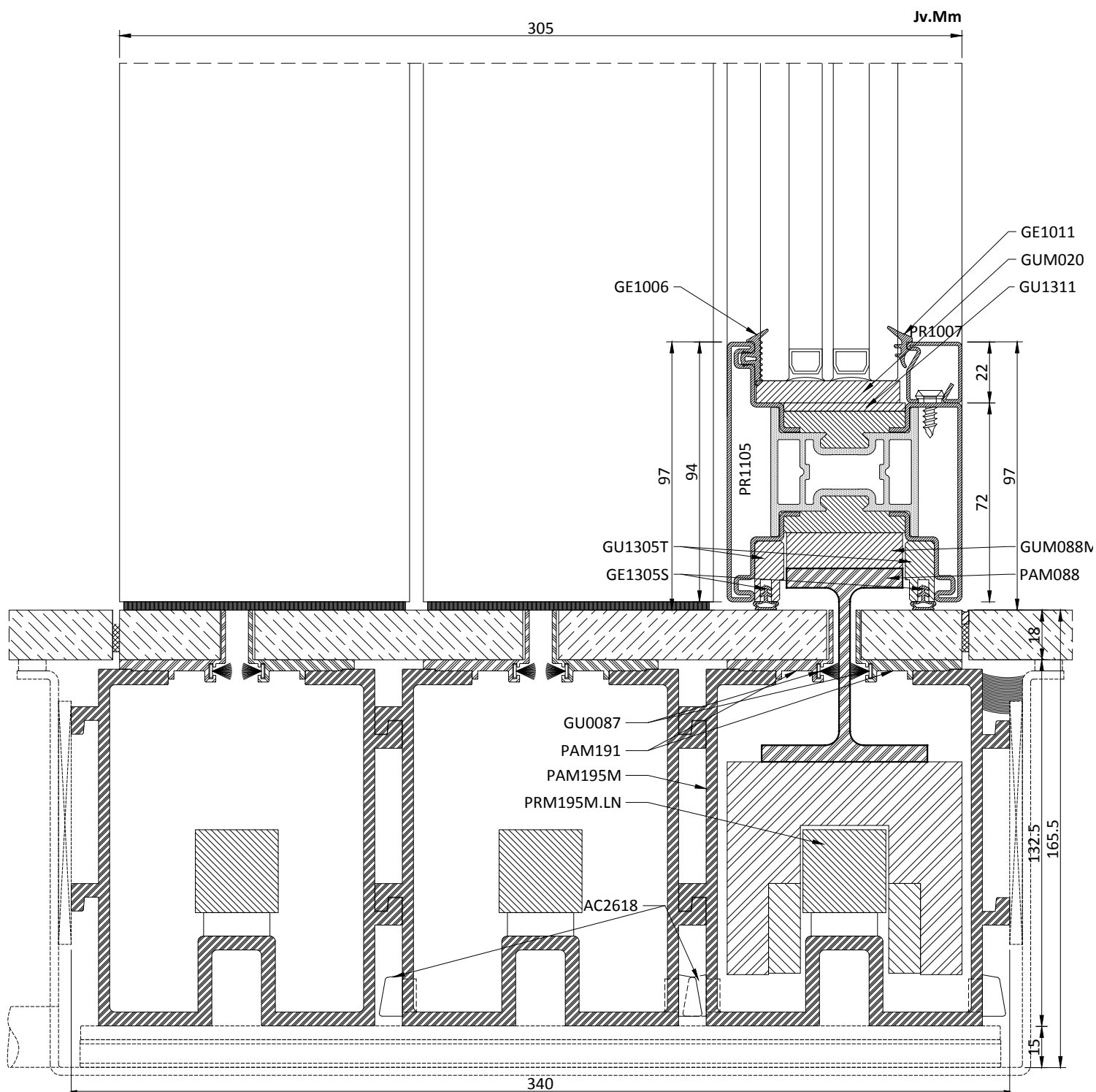
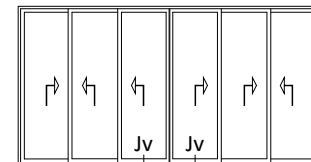

Schema | Type A

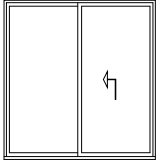

Schema | Type B

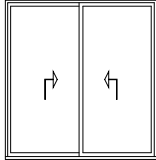

Schema | Type C

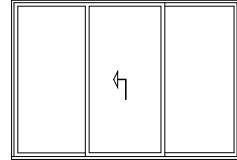

Schema | Type E

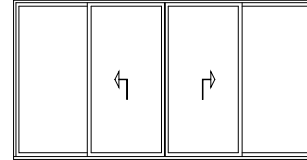

Schema | Type F

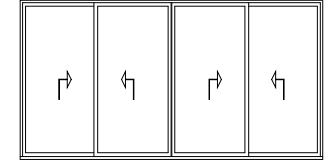

Schema | Type A3

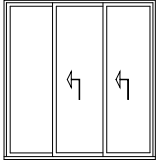

Schema | Type B3

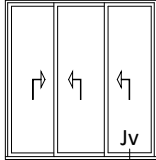

Schema | Type C3

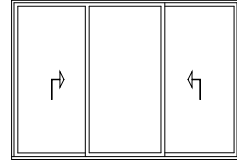

Schema | Type E3

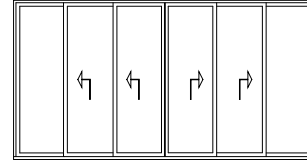

Schema | Type F3

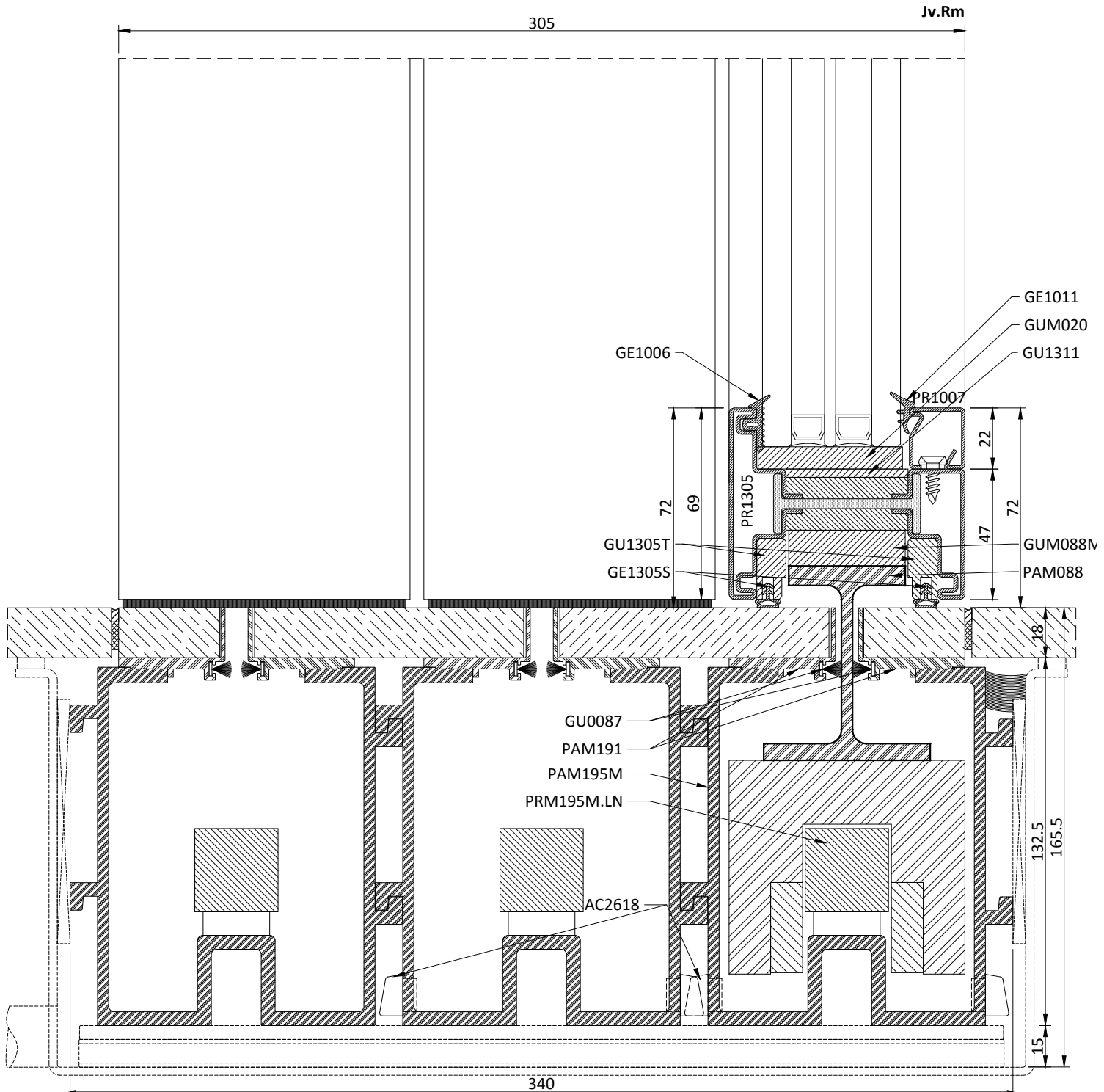
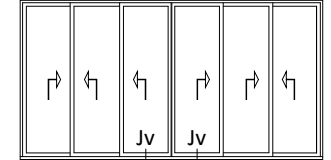

Schema | Type A

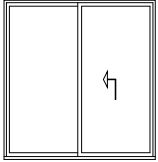

Schema | Type B

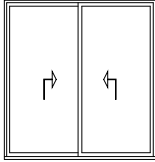

Schema | Type C

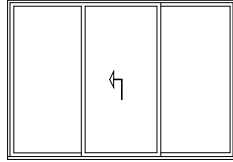

Schema | Type E

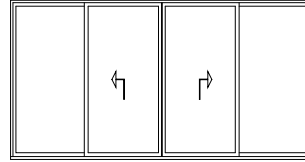

Schema | Type F

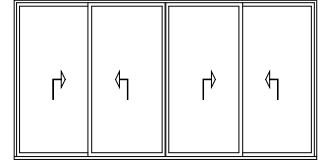

Schema | Type A3

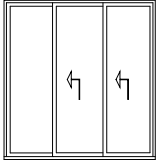

Schema | Type B3

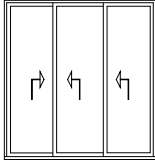

Schema | Type C3

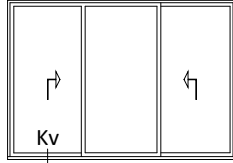

Schema | Type E3

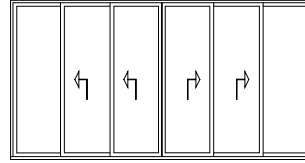

Schema | Type F3

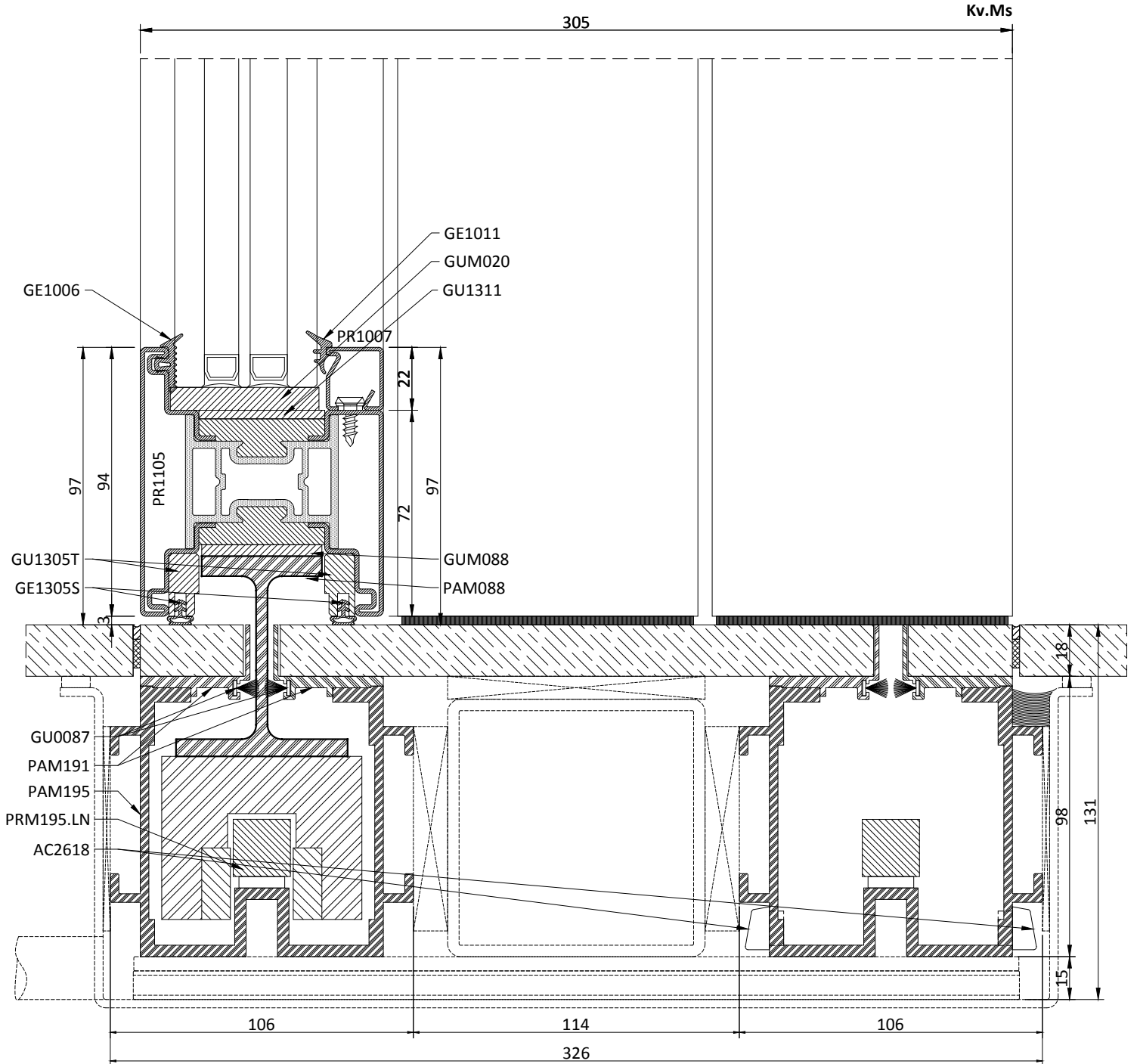
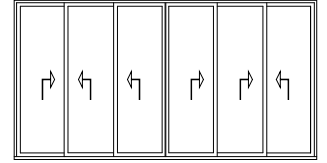

Schema | Type A

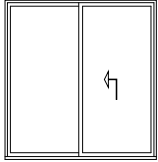

Schema | Type B

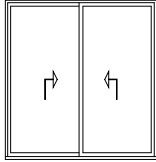

Schema | Type C

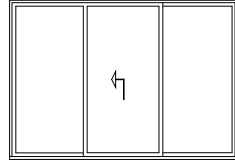

Schema | Type E

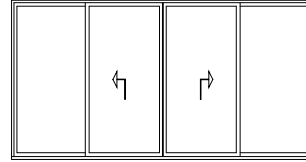

Schema | Type F

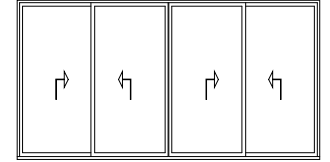

Schema | Type A3

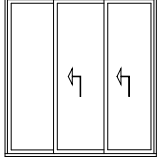

Schema | Type B3

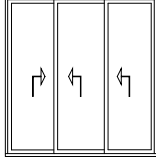

Schema | Type C3

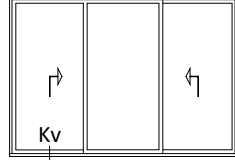

Schema | Type E3

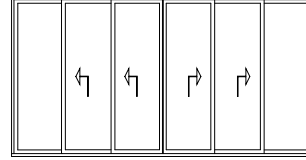

Schema | Type F3

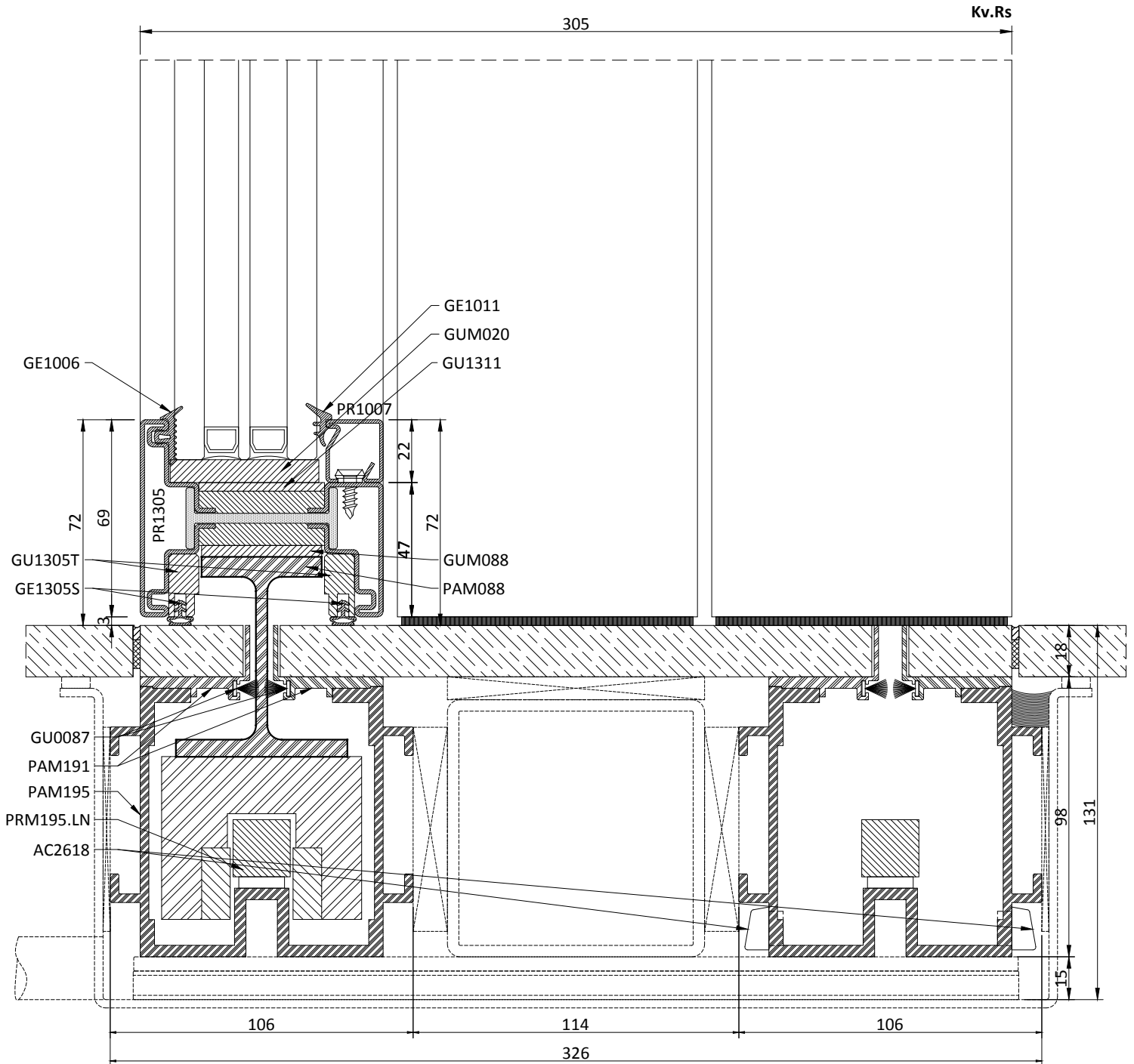
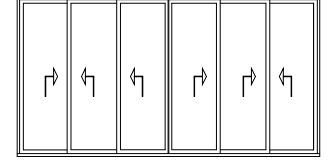

Schema | Type A

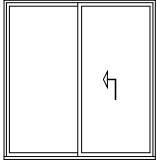

Schema | Type B

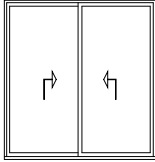

Schema | Type C

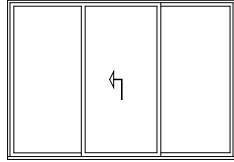

Schema | Type E

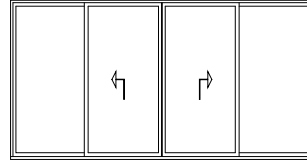

Schema | Type F

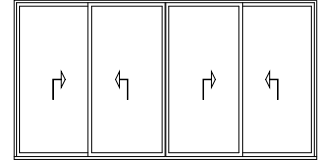

Schema | Type A3

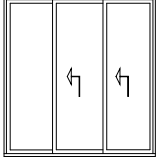

Schema | Type B3

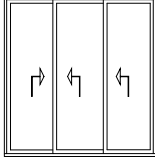

Schema | Type C3

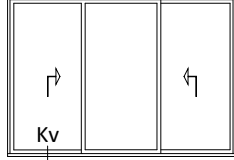

Schema | Type E3

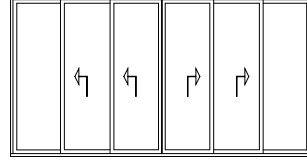

Schema | Type F3

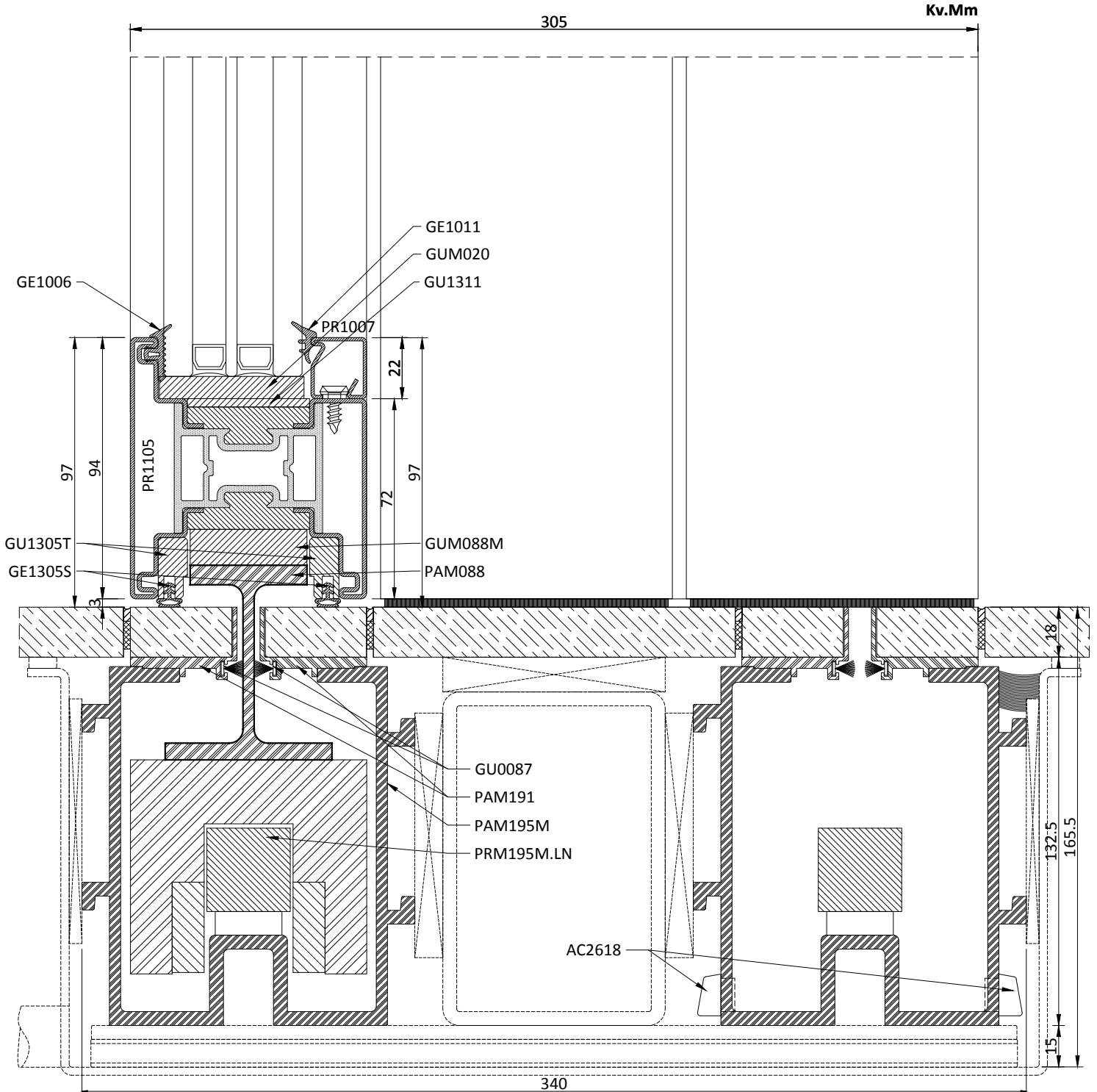
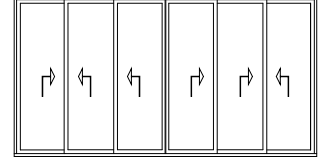

Schema | Type A

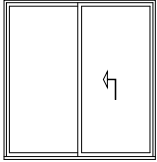

Schema | Type B

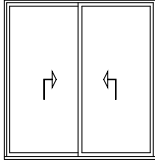

Schema | Type C

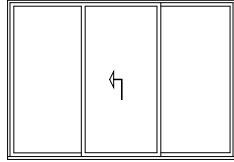

Schema | Type E

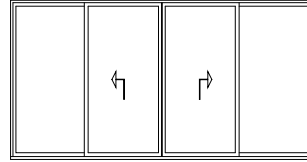

Schema | Type F

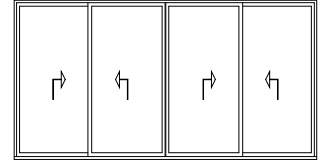

Schema | Type A3

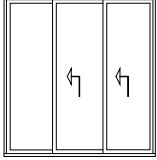

Schema | Type B3

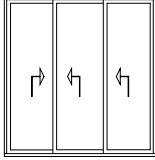

Schema | Type C3

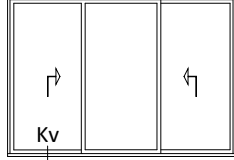

Schema | Type E3

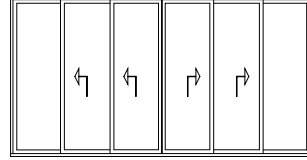

Schema | Type F3

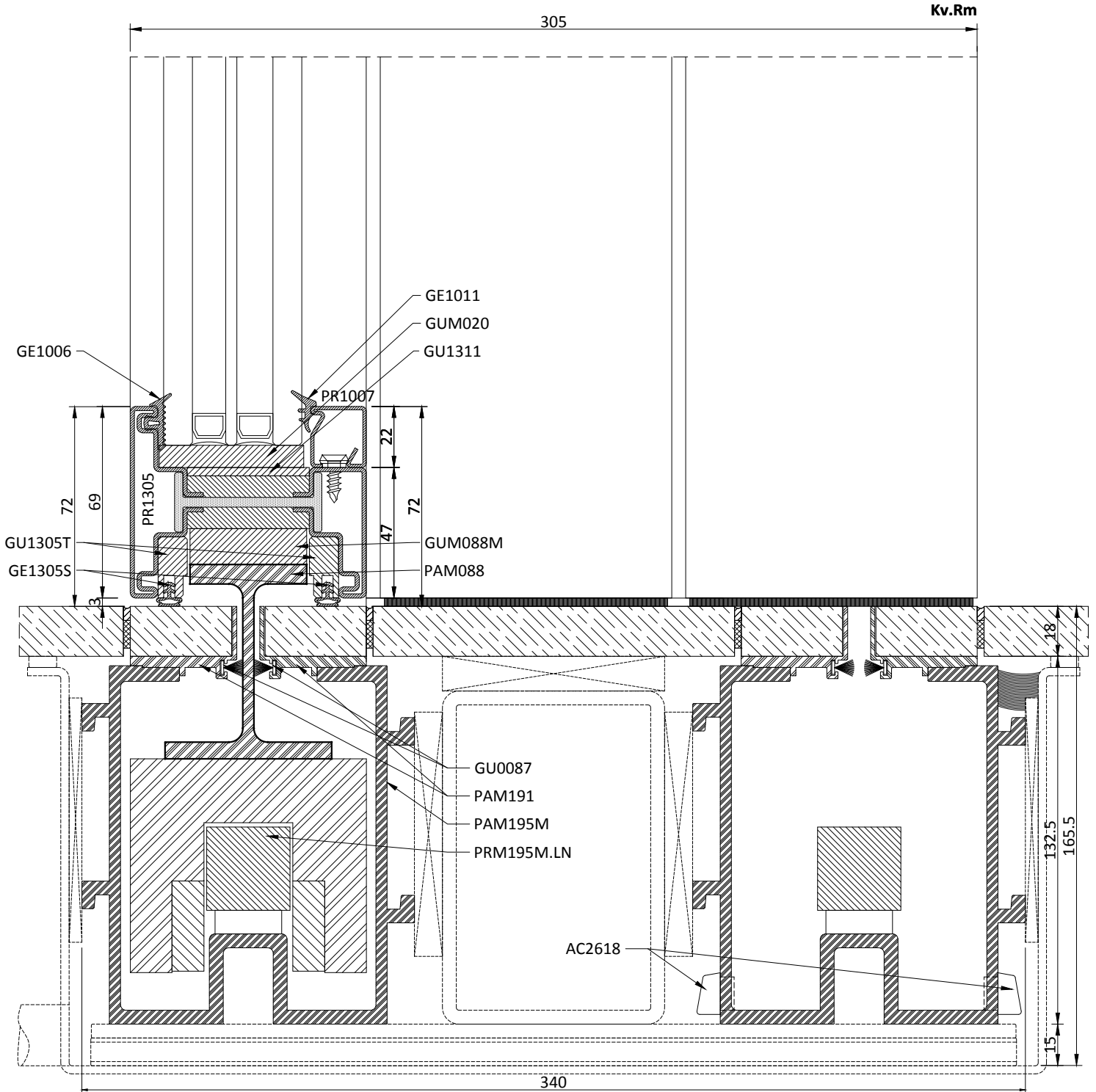
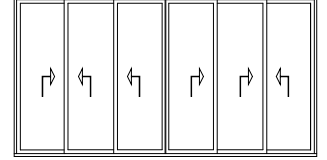

Schema | Type A

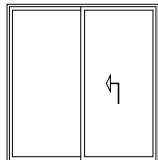

Schema | Type B

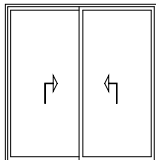

Schema | Type C

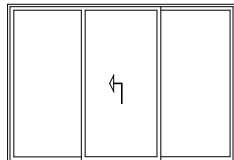

Schema | Type E

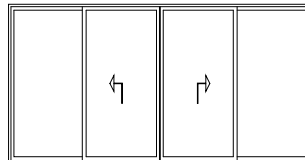

Schema | Type F

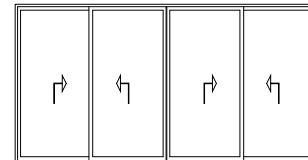

Schema | Type A3

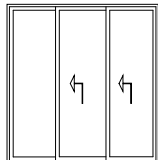

Schema | Type B3

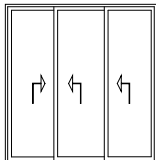

Schema | Type C3

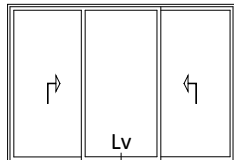

Schema | Type E3

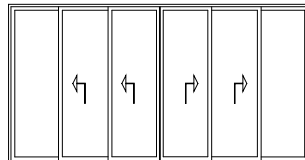

Schema | Type F3

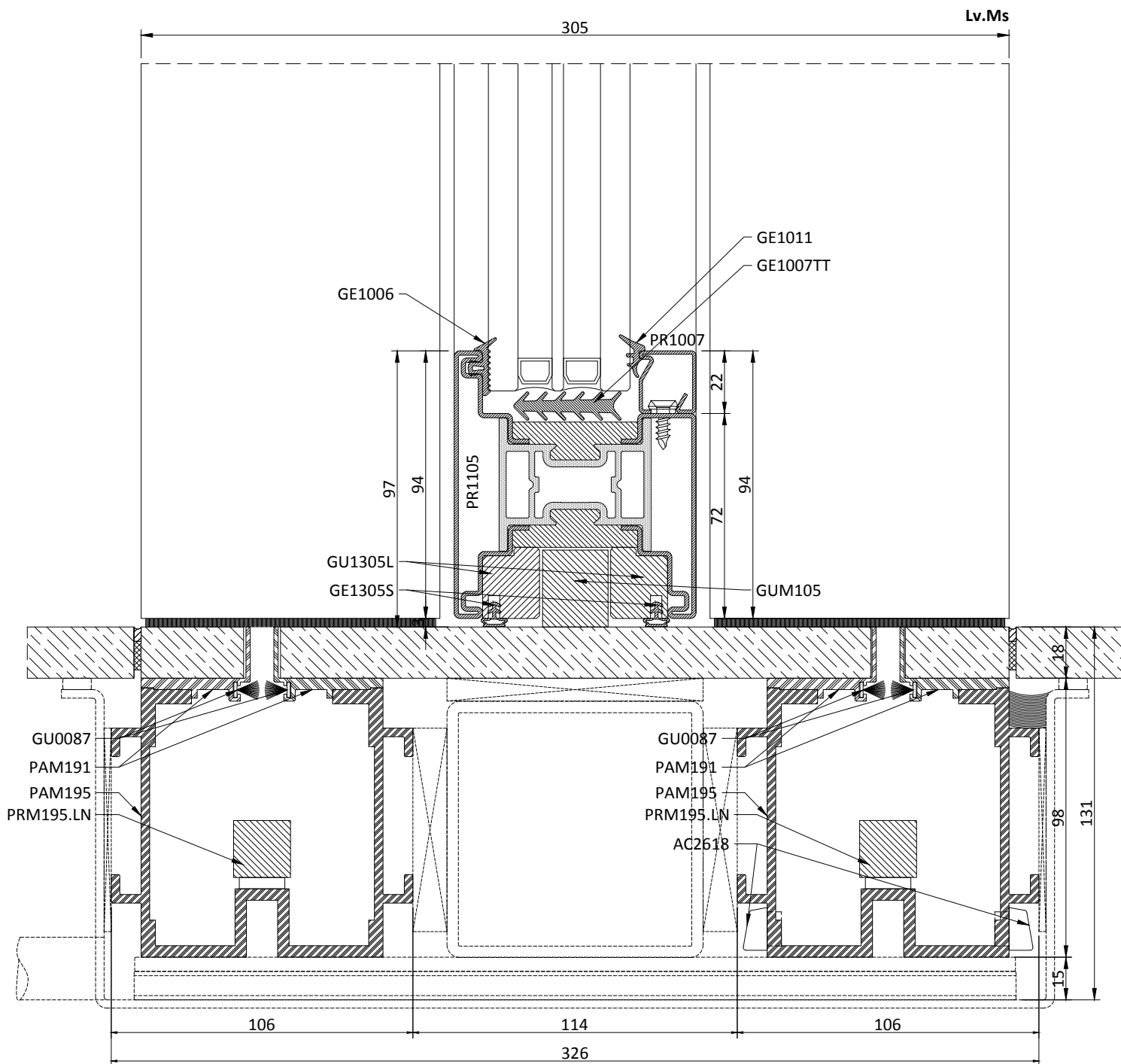
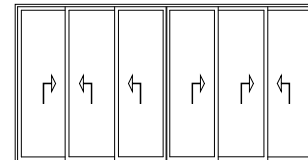

Schema | Type A

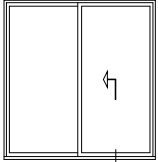

Schema | Type B

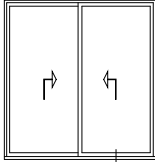

Schema | Type C

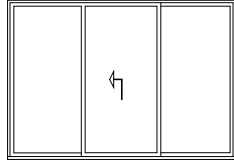

Schema | Type E

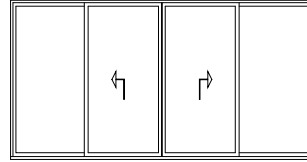

Schema | Type F

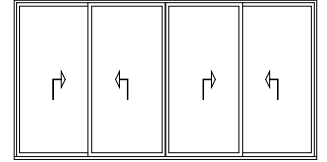

Schema | Type A3

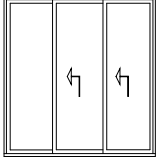

Schema | Type B3

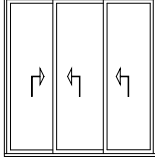

Schema | Type C3

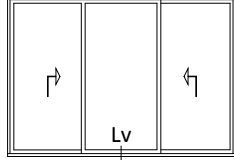

Schema | Type E3

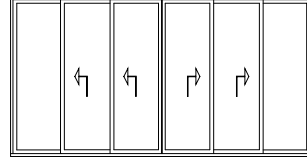

Schema | Type F3

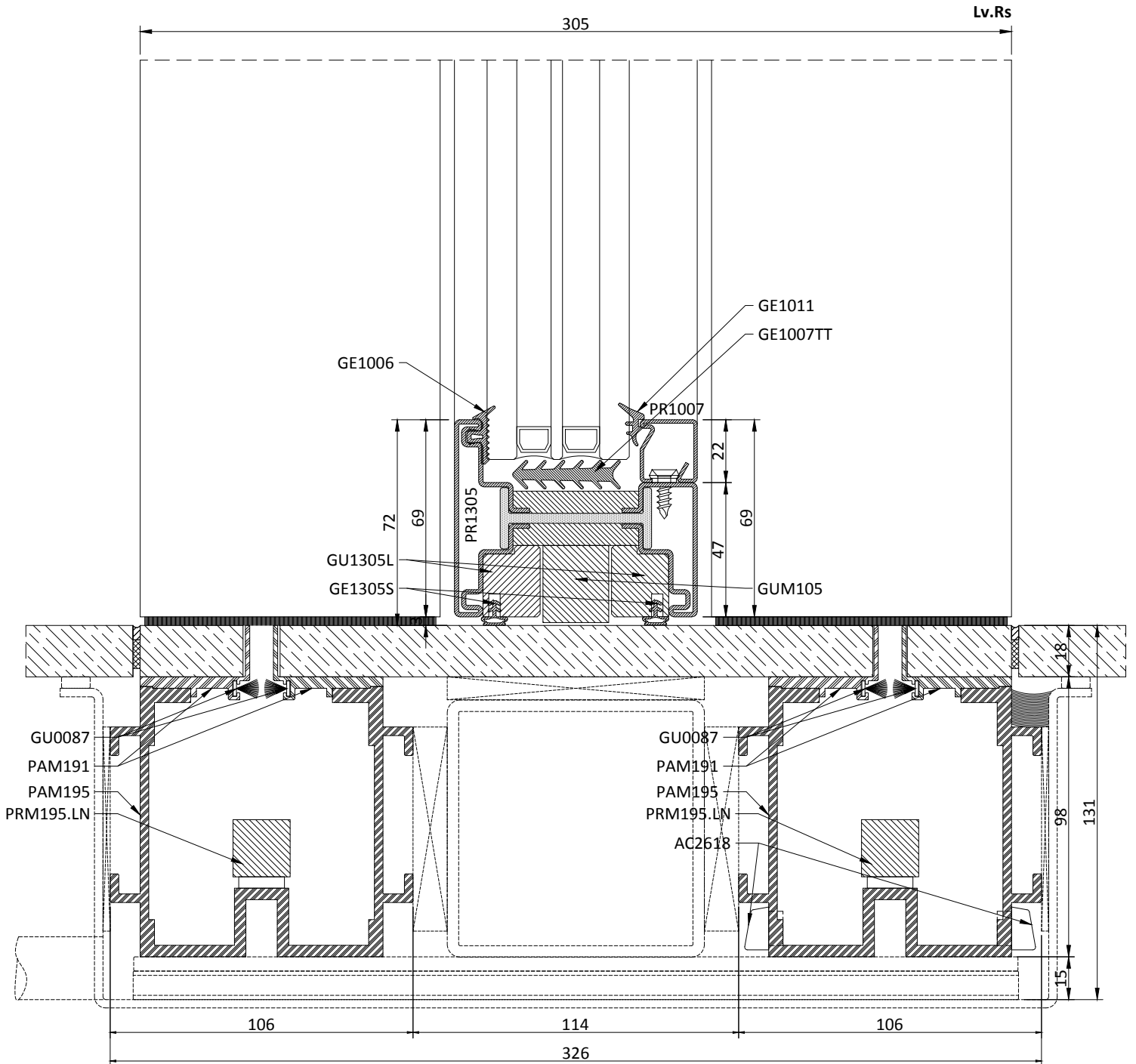
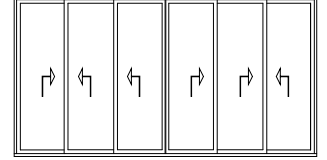



Schema | Type A

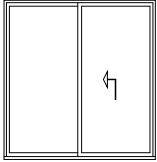

Schema | Type B

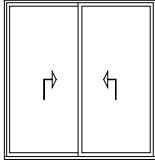

Schema | Type C

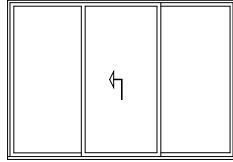

Schema | Type E

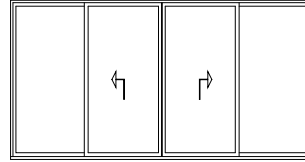

Schema | Type F

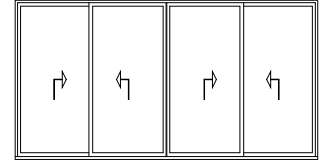

Schema | Type A3

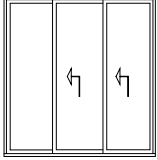

Schema | Type B3

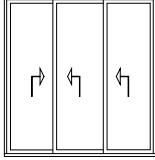

Schema | Type C3

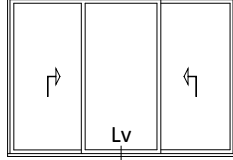

Schema | Type E3

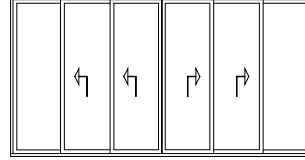

Schema | Type F3

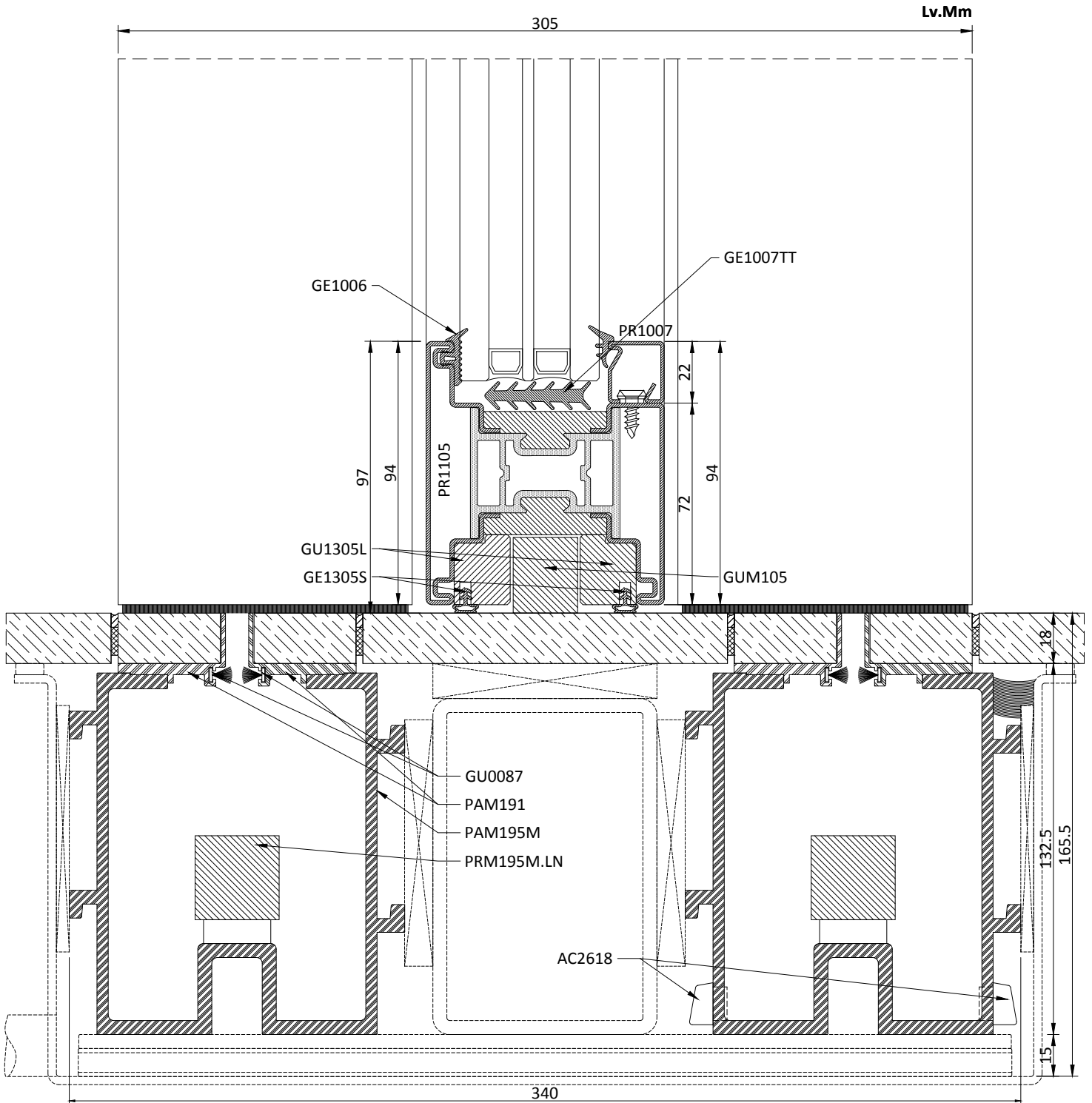
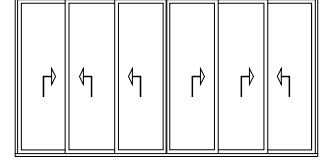

Schema | Type A

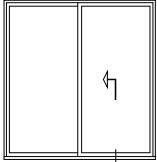

Schema | Type B

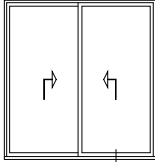

Schema | Type C

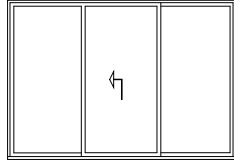

Schema | Type E

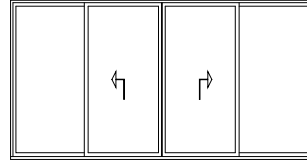

Schema | Type F

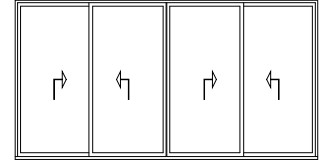

Schema | Type A3

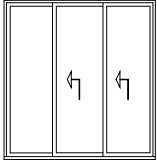

Schema | Type B3

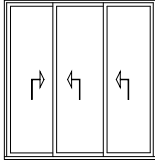

Schema | Type C3

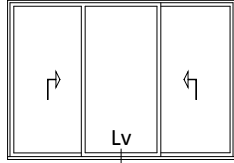

Schema | Type E3

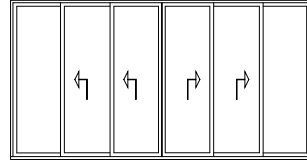

Schema | Type F3

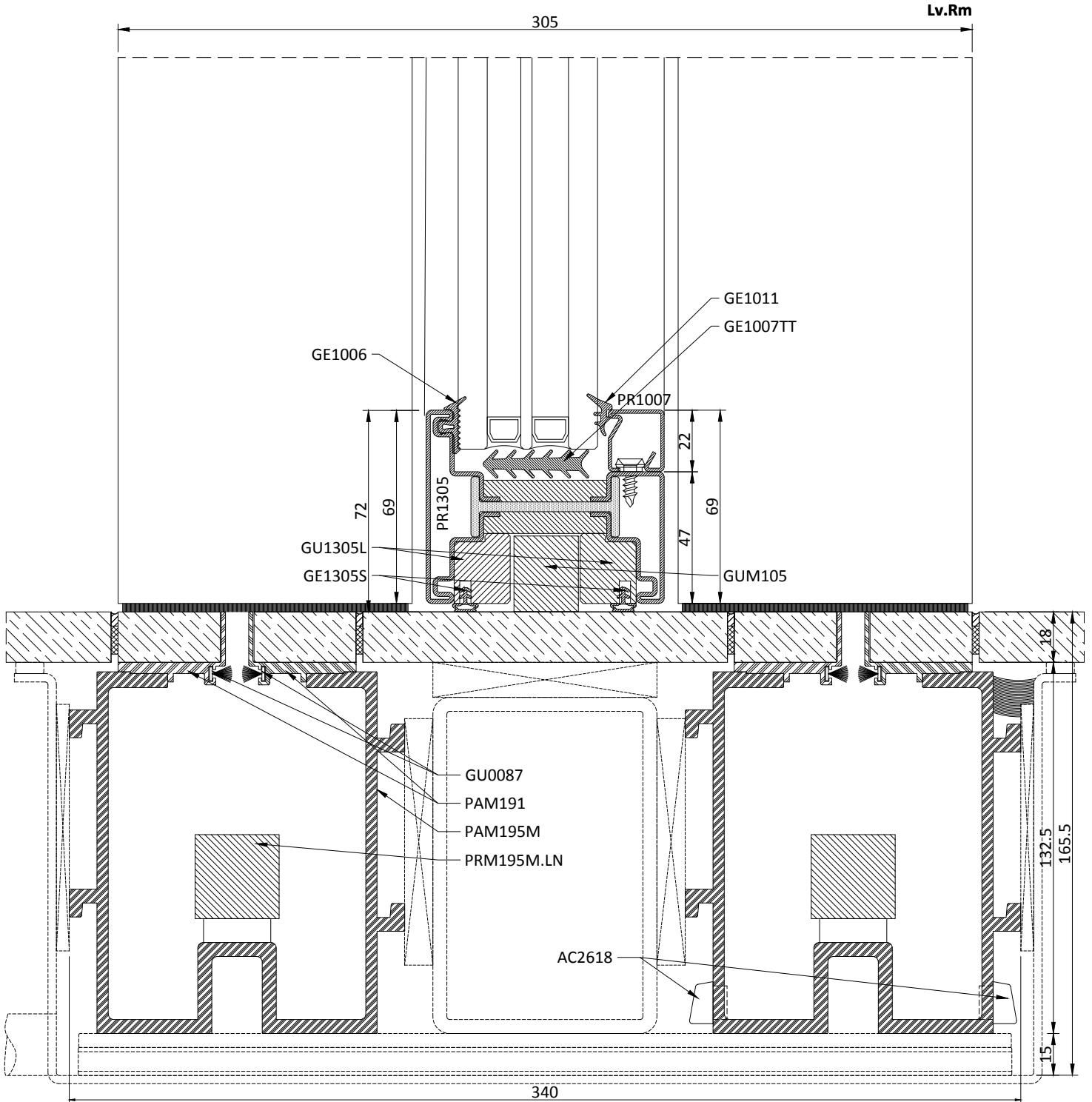
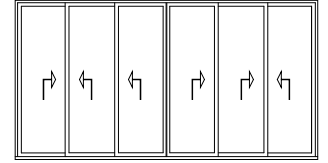

Schema | Type A

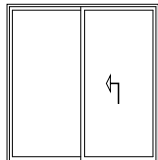

Schema | Type B

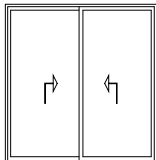

Schema | Type C

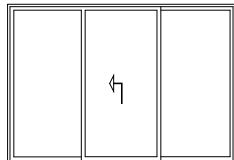

Schema | Type E

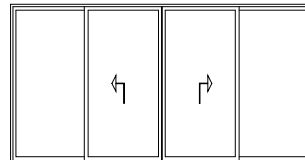

Schema | Type F

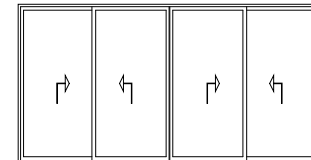

Schema | Type A3

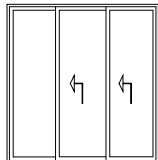

Schema | Type B3

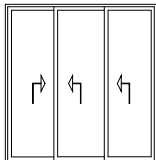

Schema | Type C3

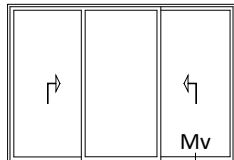

Schema | Type E3

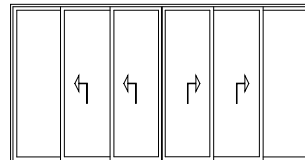

Schema | Type F3

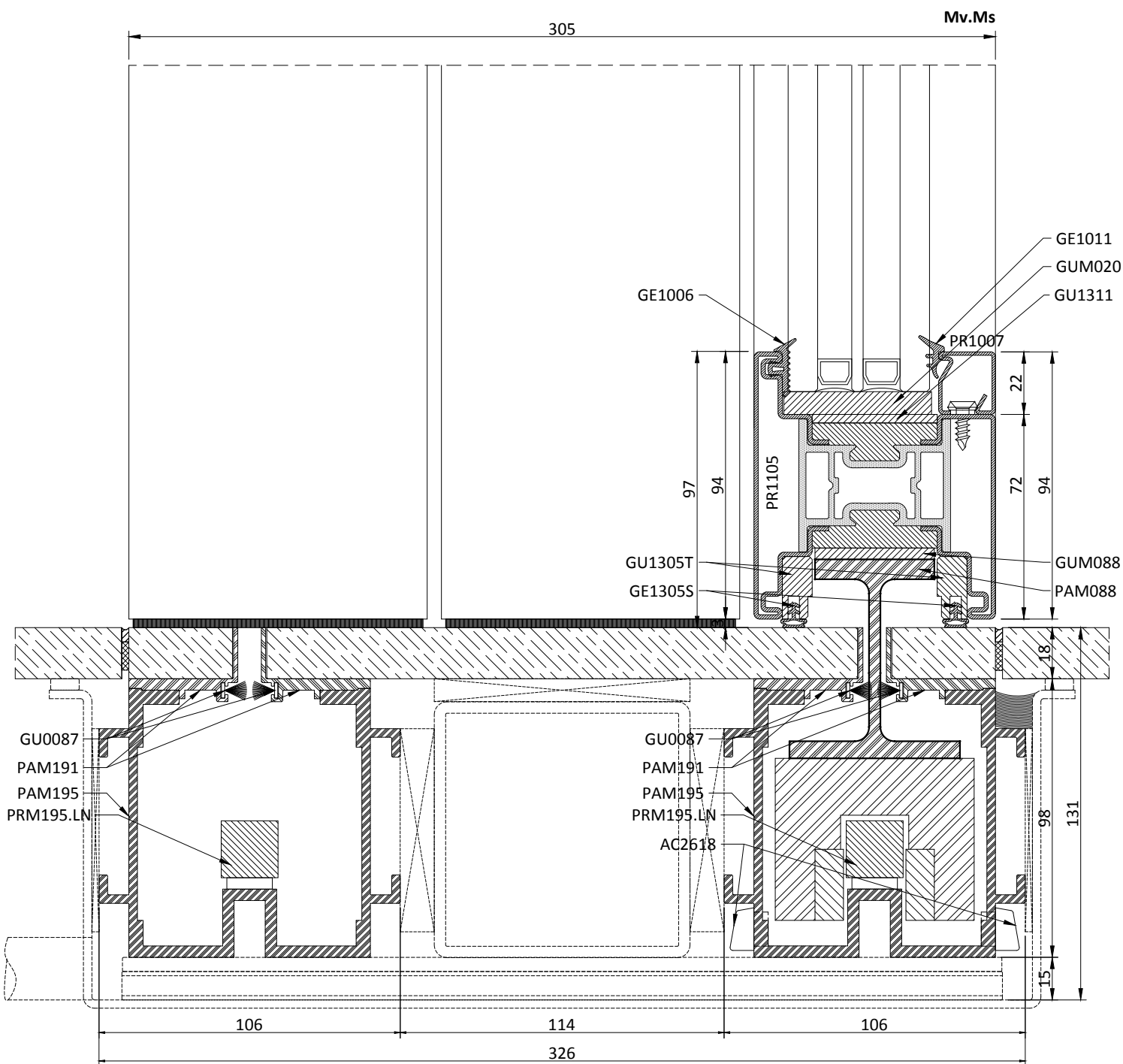
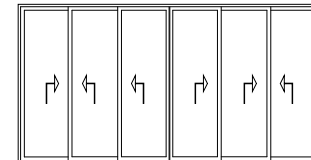

Schema | Type A

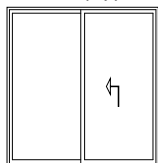

Schema | Type B

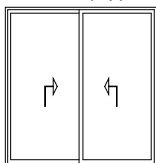

Schema | Type C

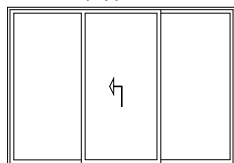

Schema | Type E

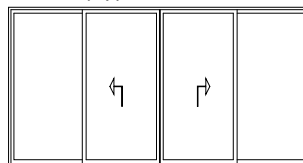

Schema | Type F

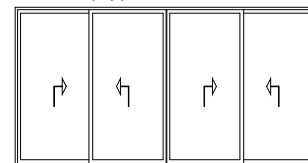

Schema | Type A3

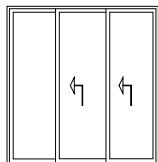

Schema | Type B3

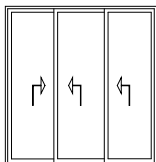

Schema | Type C3

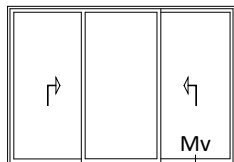

Schema | Type E3

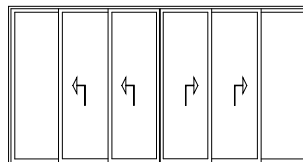

Schema | Type F3

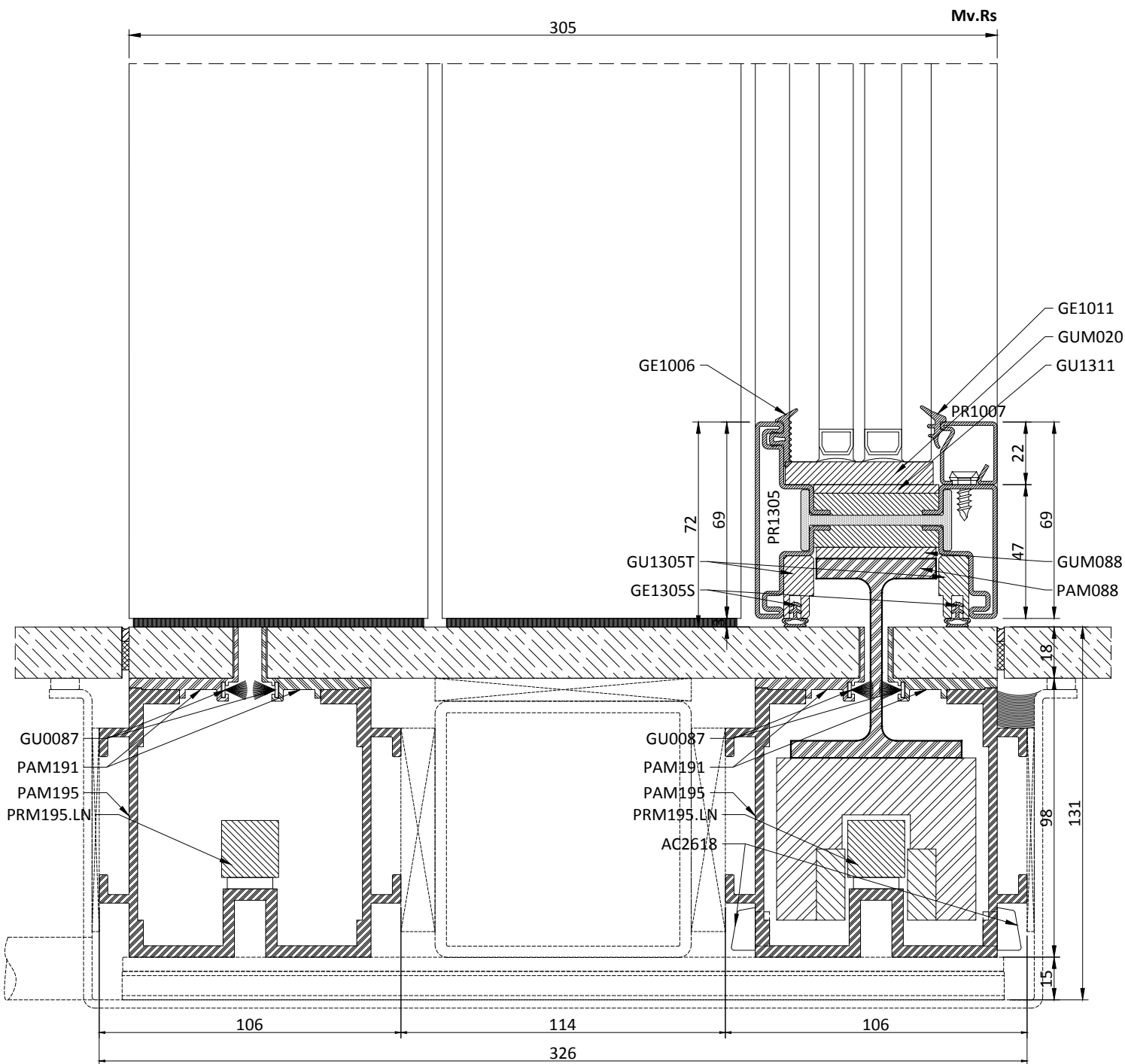
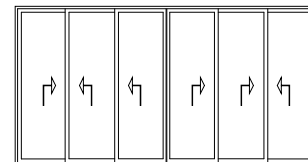

Schema | Type A

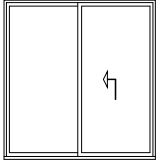

Schema | Type B

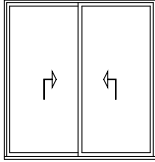

Schema | Type C

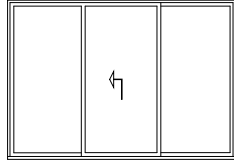

Schema | Type E

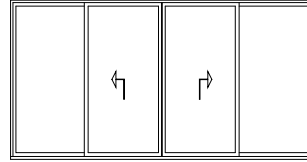

Schema | Type F

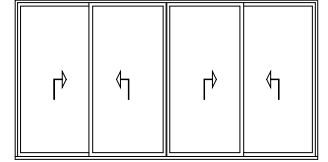

Schema | Type A3

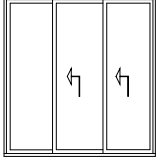

Schema | Type B3

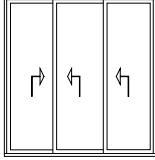

Schema | Type C3

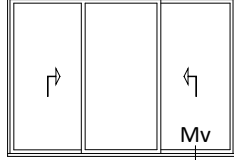

Schema | Type E3

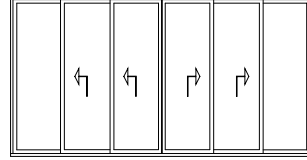

Schema | Type F3

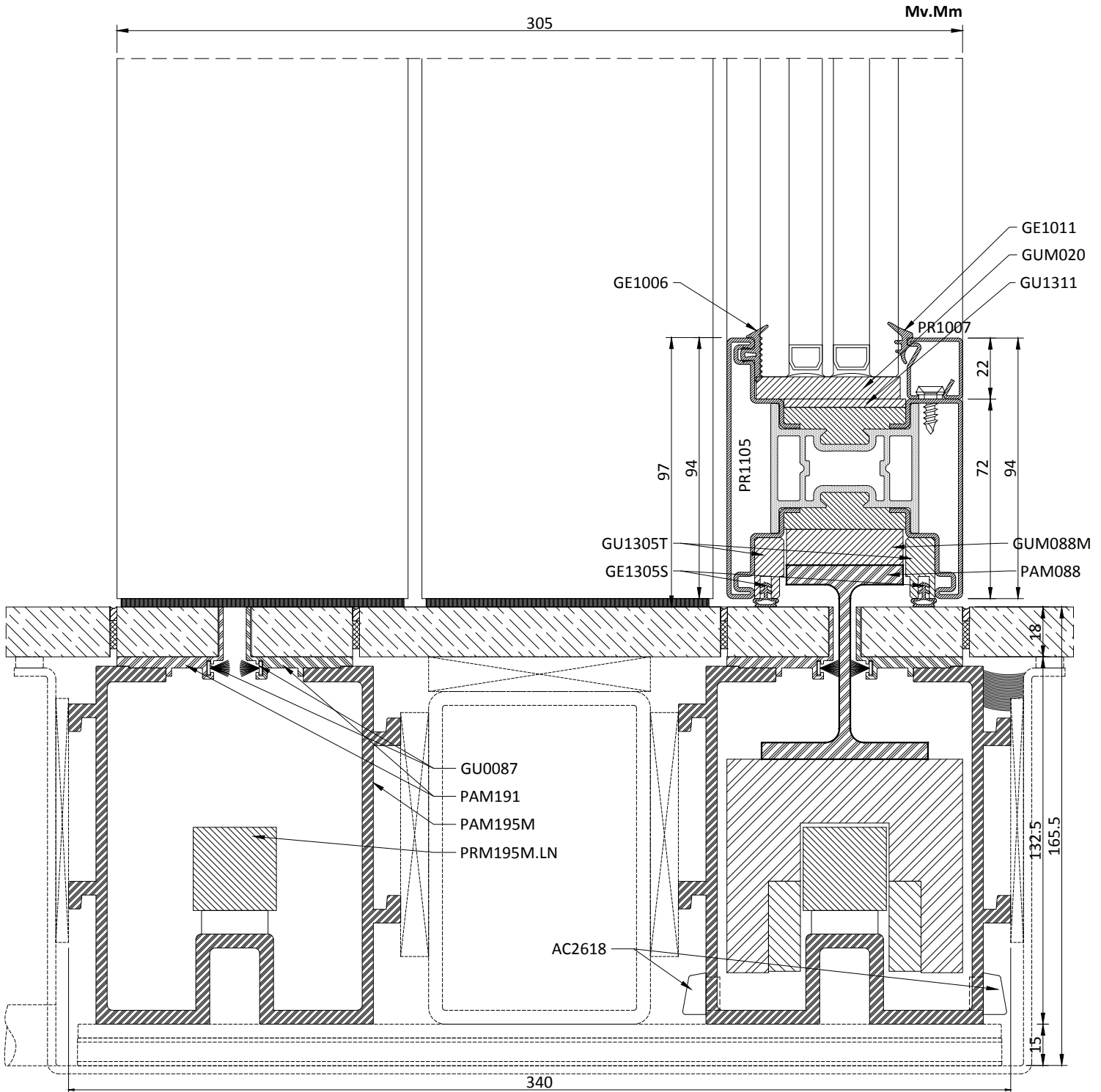
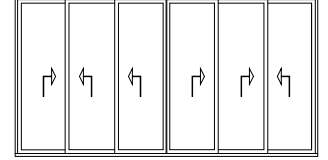

Schema | Type A

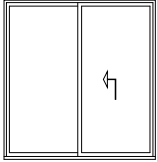

Schema | Type B

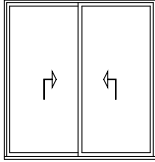

Schema | Type C

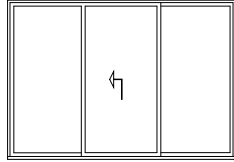

Schema | Type E

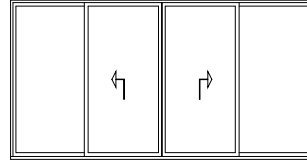

Schema | Type F

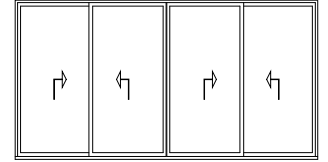

Schema | Type A3

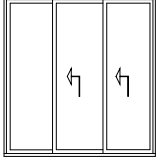

Schema | Type B3

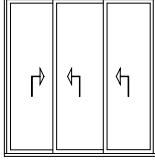

Schema | Type C3

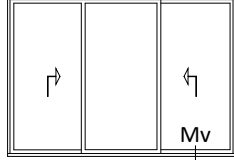

Schema | Type E3

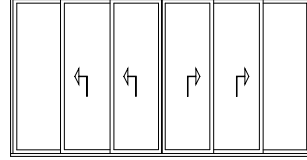

Schema | Type F3

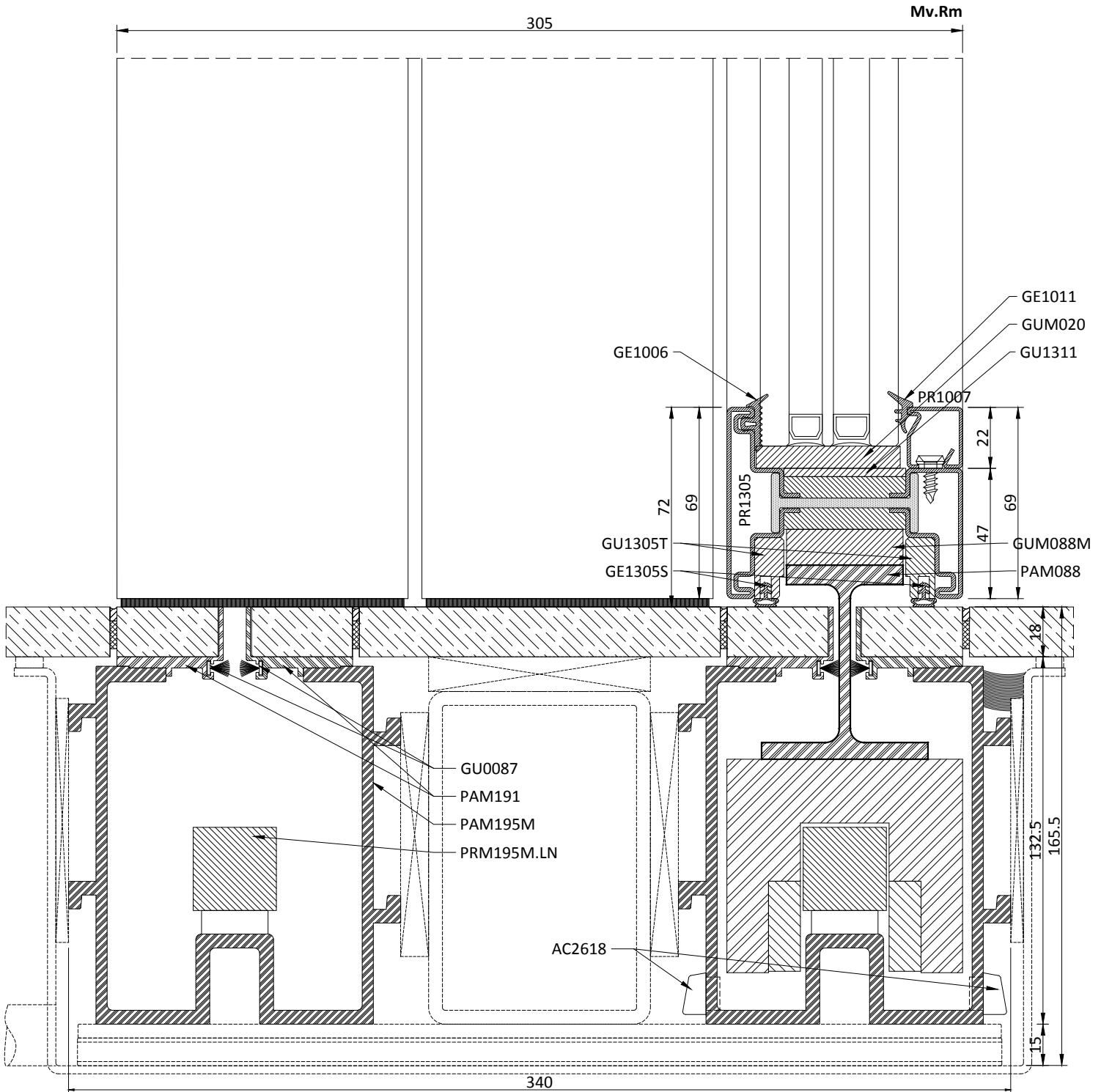
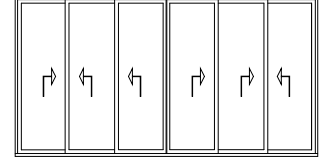

Schema | Type A

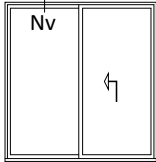

Schema | Type B

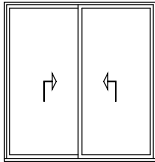

Schema | Type C

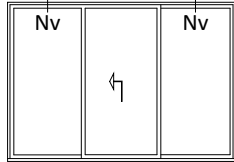

Schema | Type E

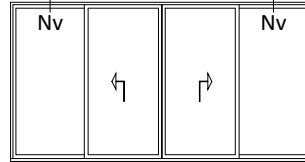

Schema | Type F

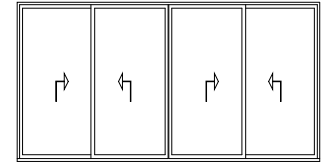

Schema | Type A3

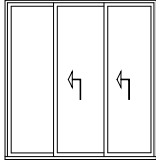

Schema | Type B3

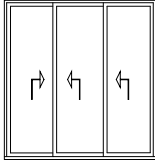

Schema | Type C3

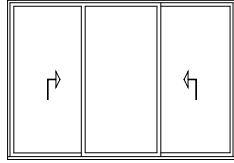

Schema | Type E3

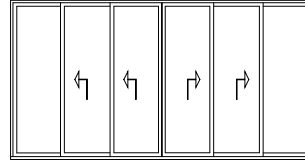

Schema | Type F3

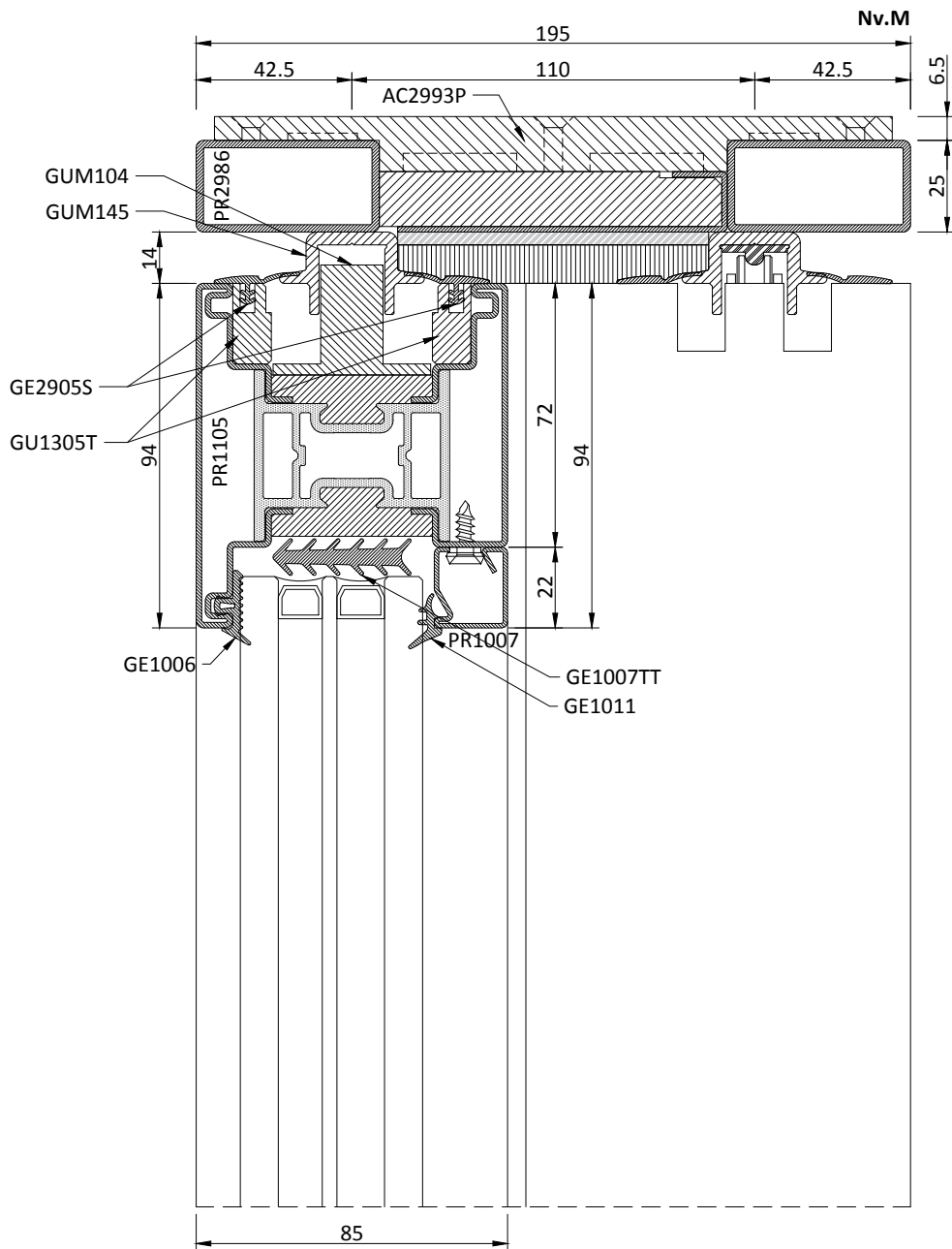
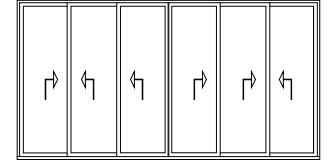

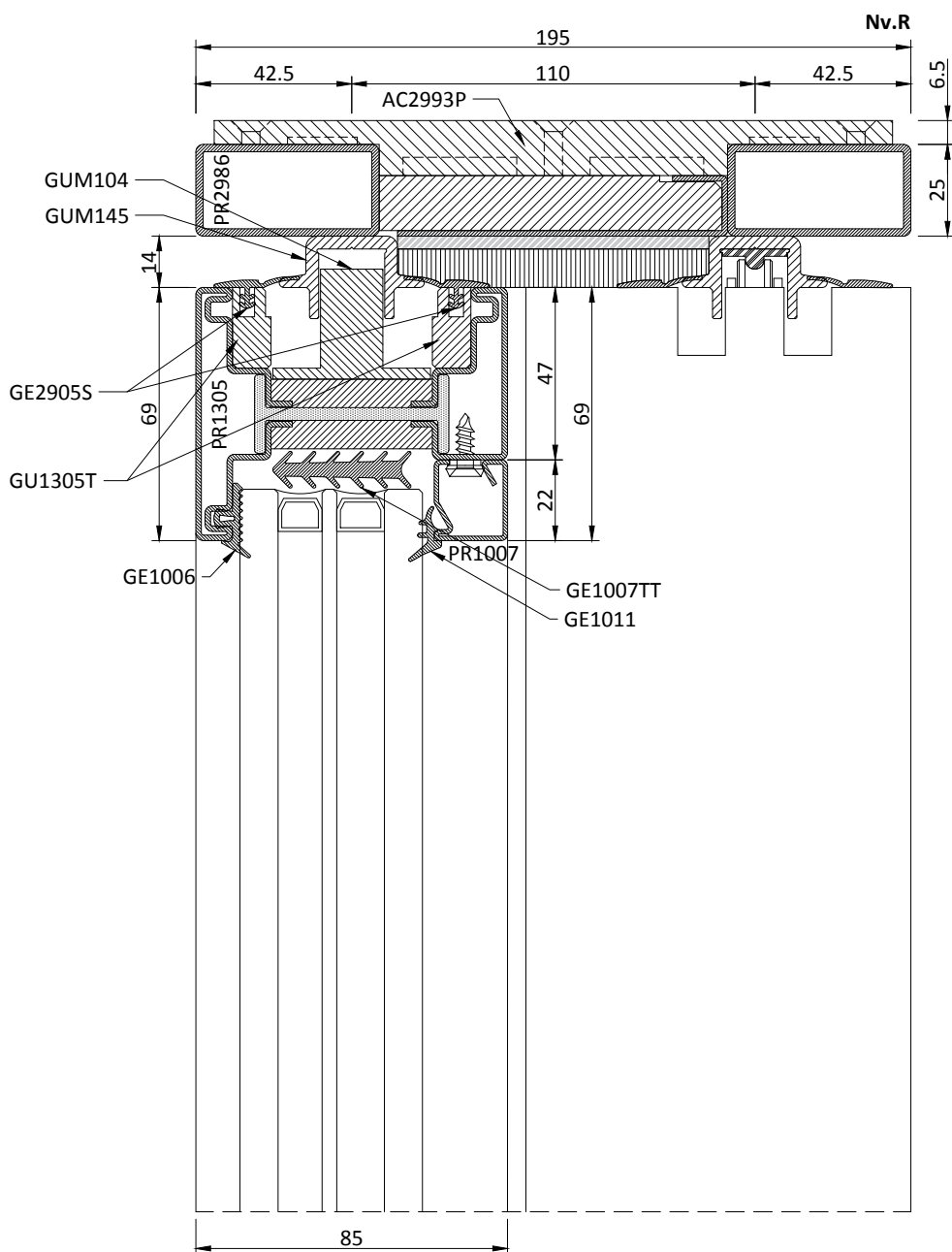
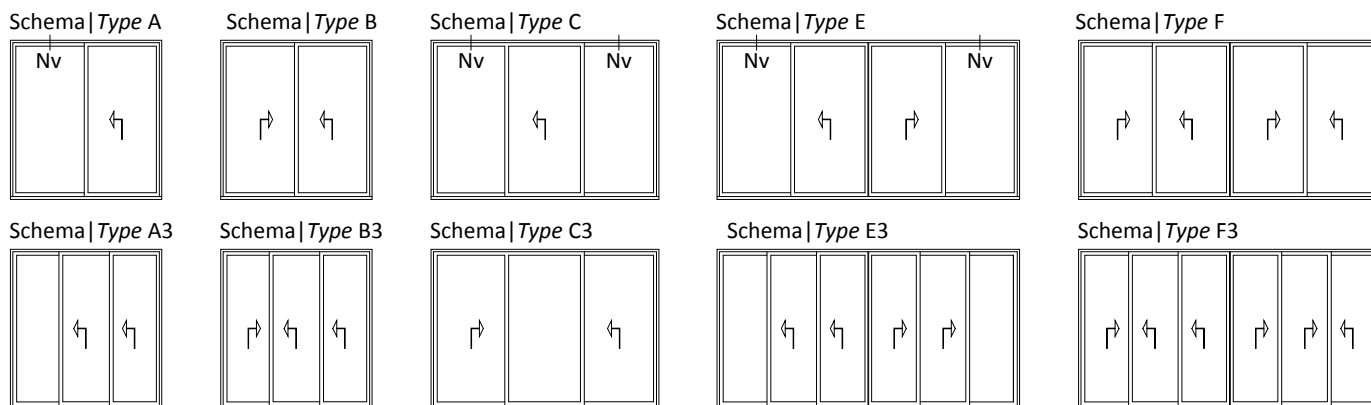



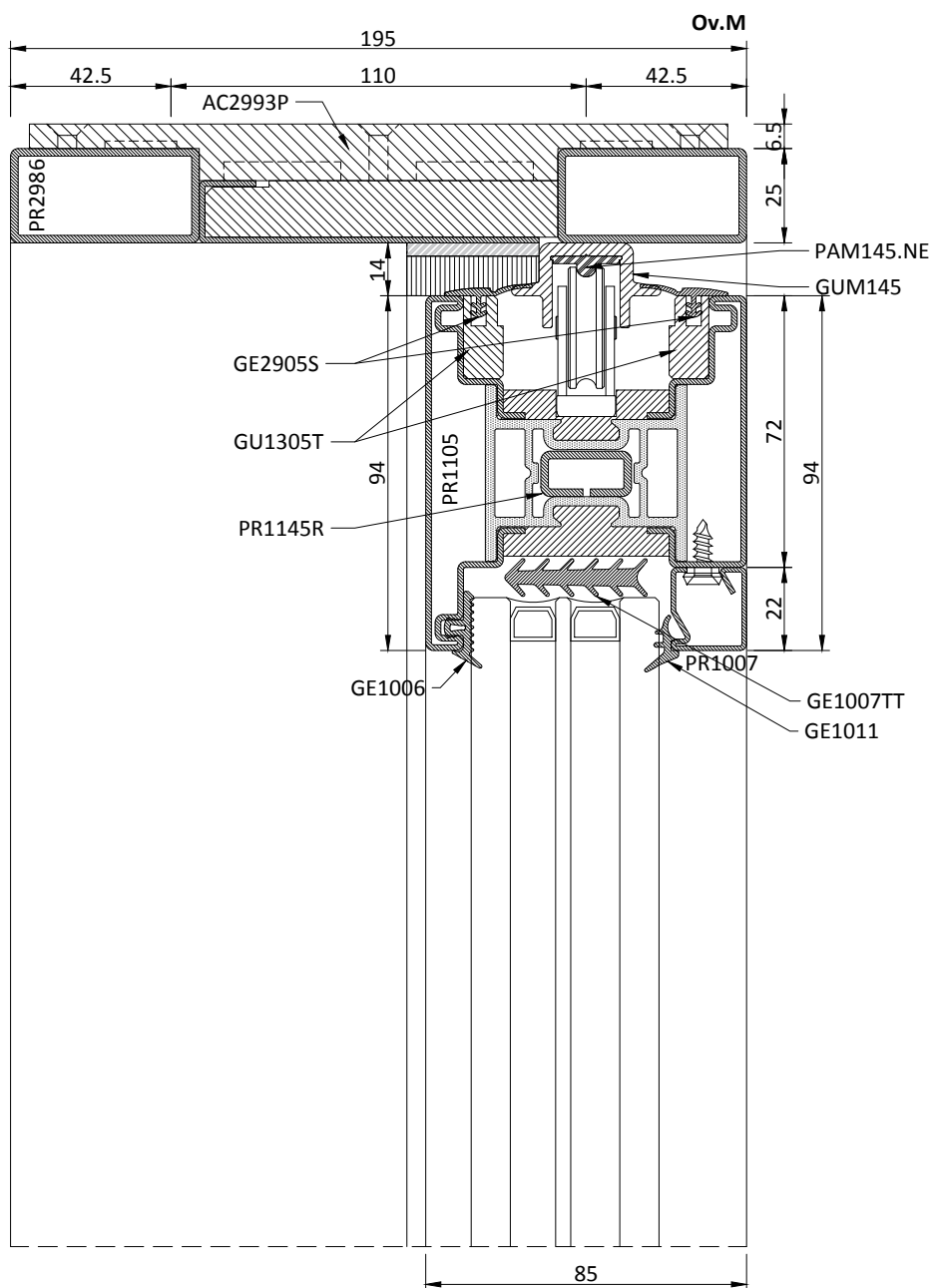
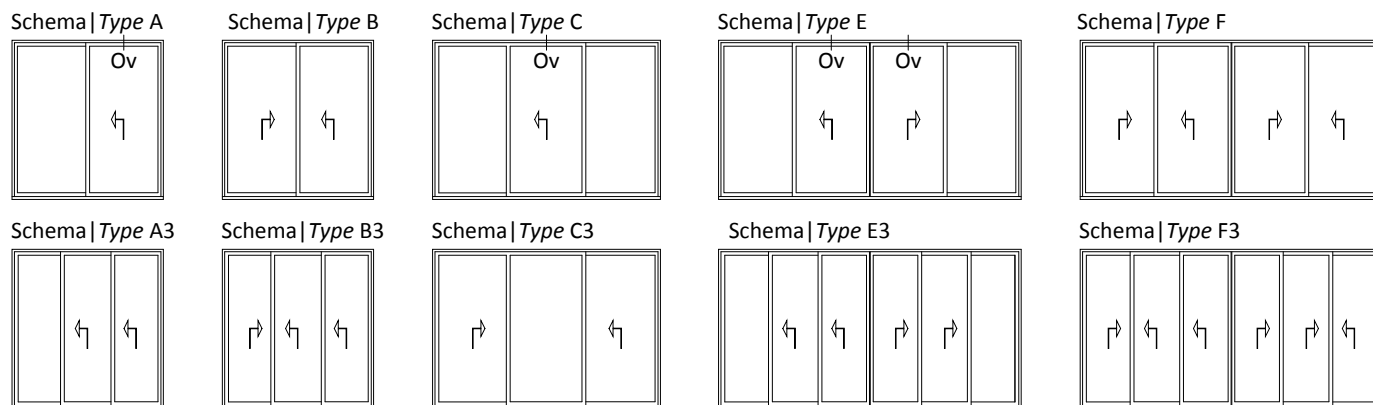

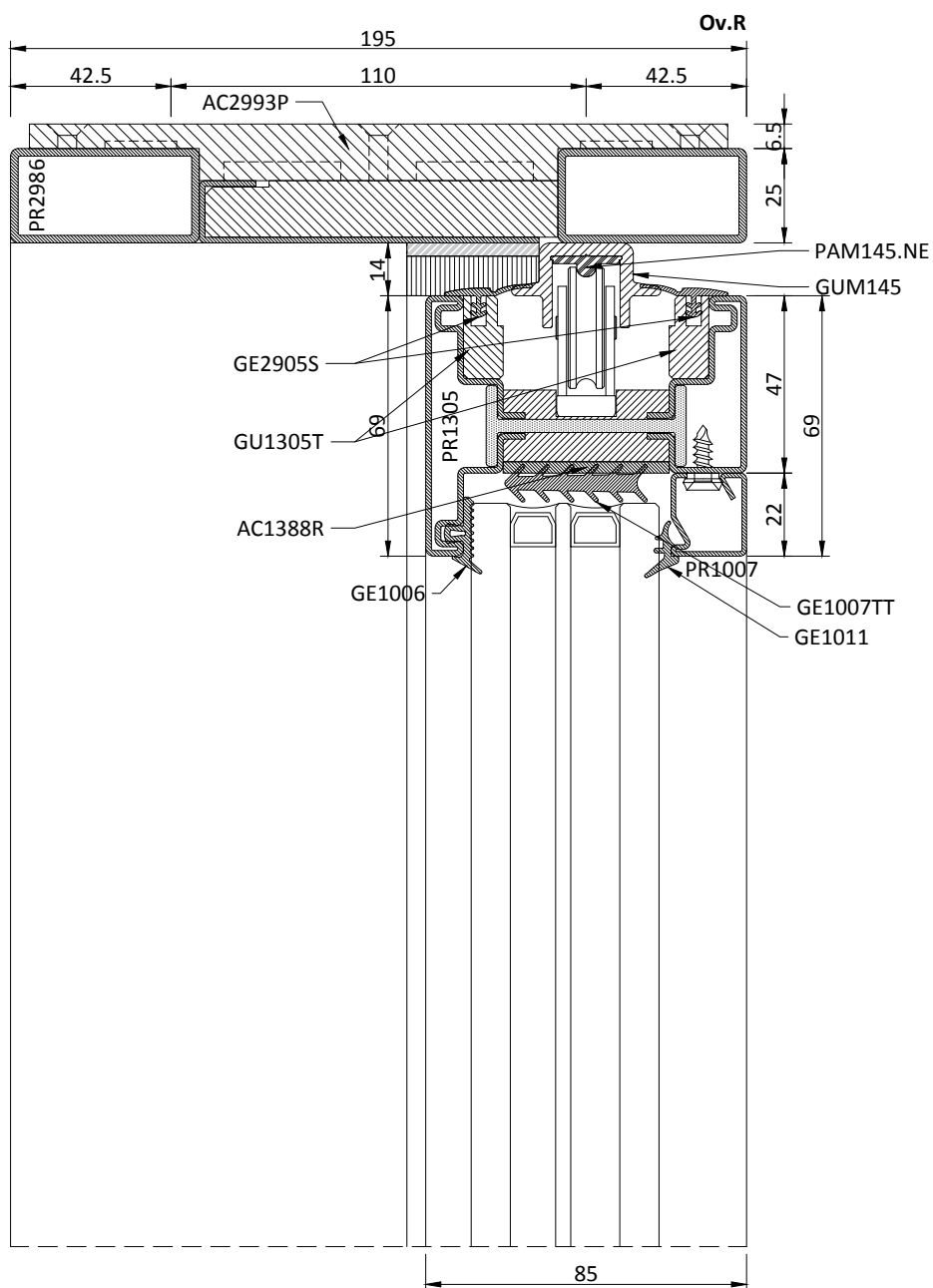
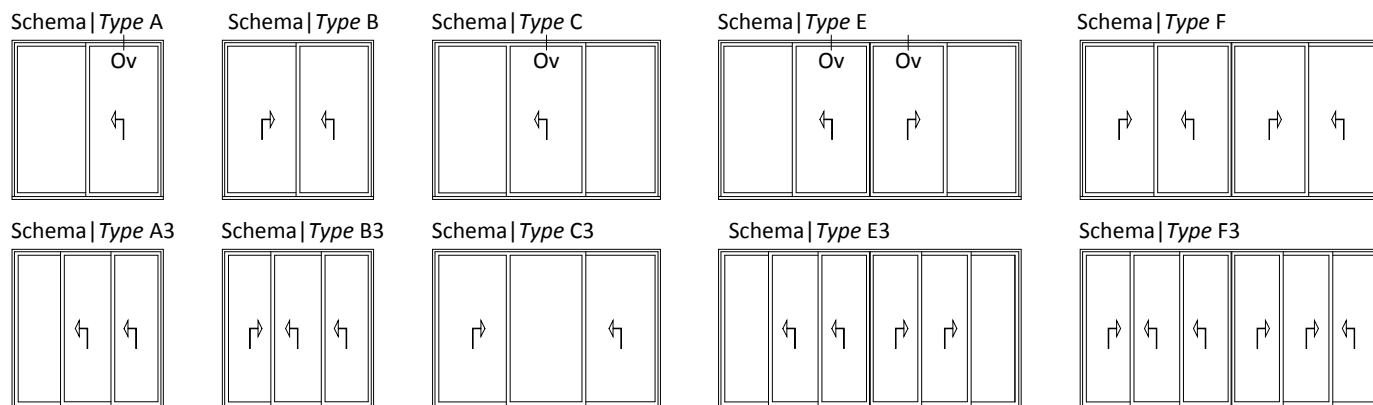

Schema | Type A

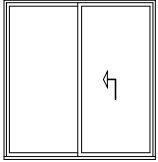

Schema | Type B

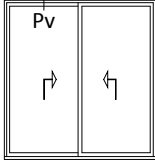

Schema | Type C

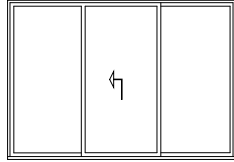

Schema | Type E

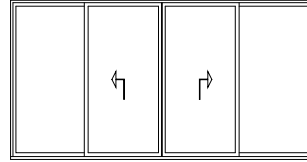

Schema | Type F

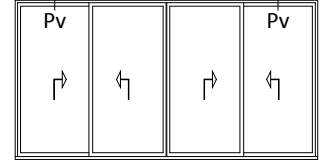

Schema | Type A3

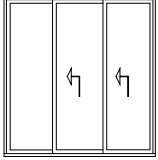

Schema | Type B3

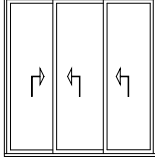

Schema | Type C3

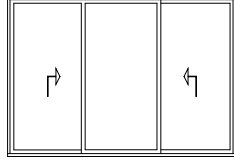

Schema | Type E3

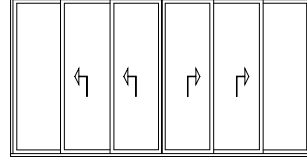

Schema | Type F3

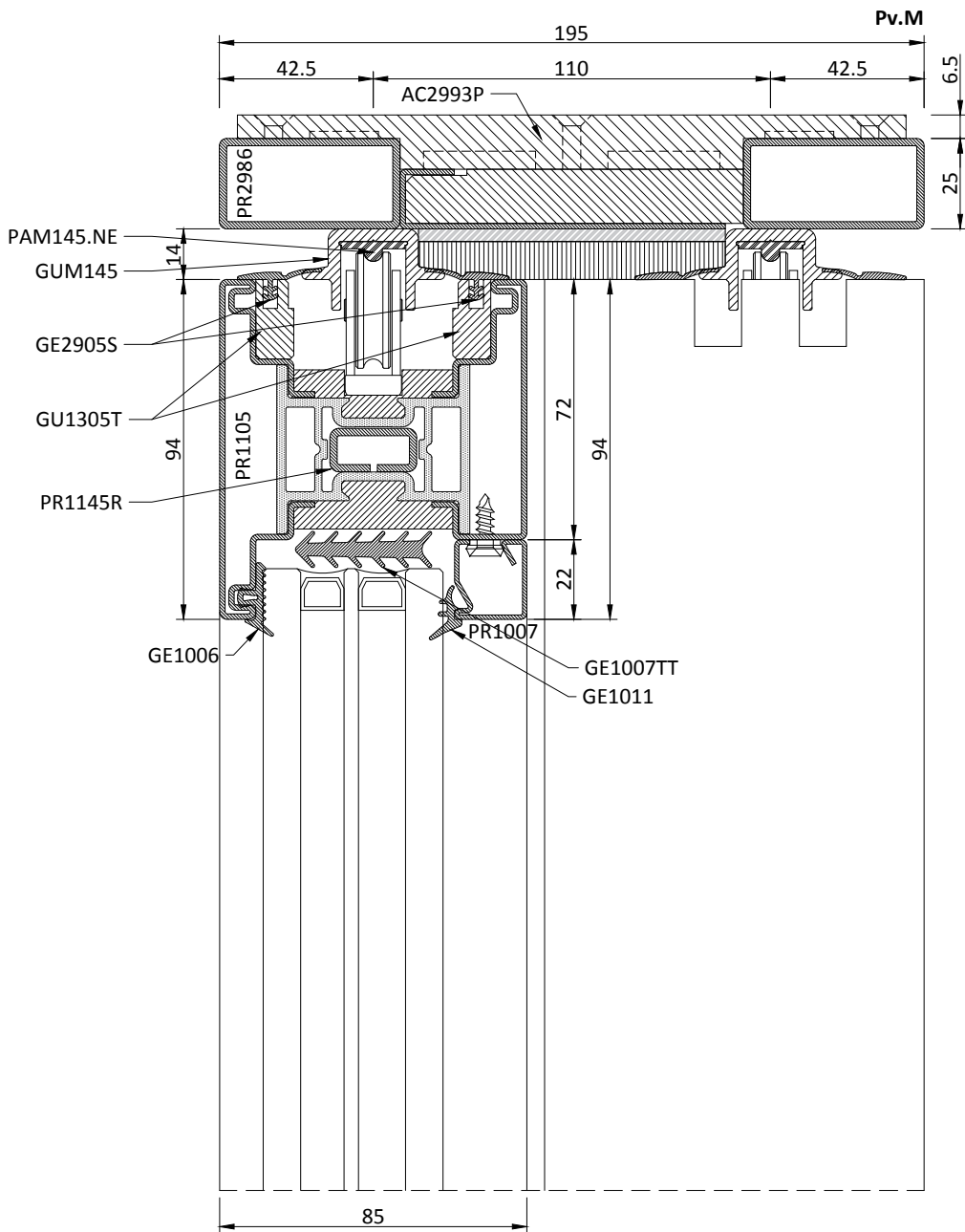
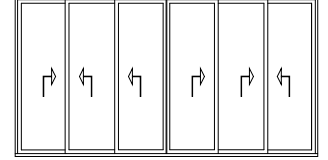

Schema | Type A

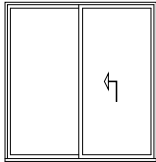

Schema | Type B

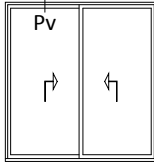

Schema | Type C

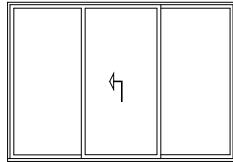

Schema | Type E

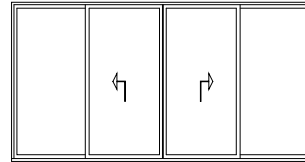

Schema | Type F

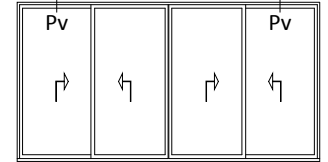

Schema | Type A3

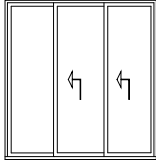

Schema | Type B3

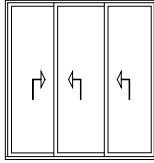

Schema | Type C3

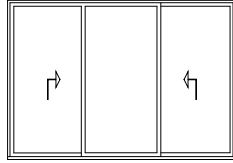

Schema | Type E3

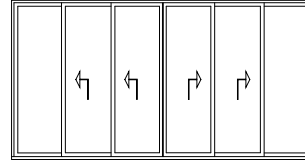

Schema | Type F3

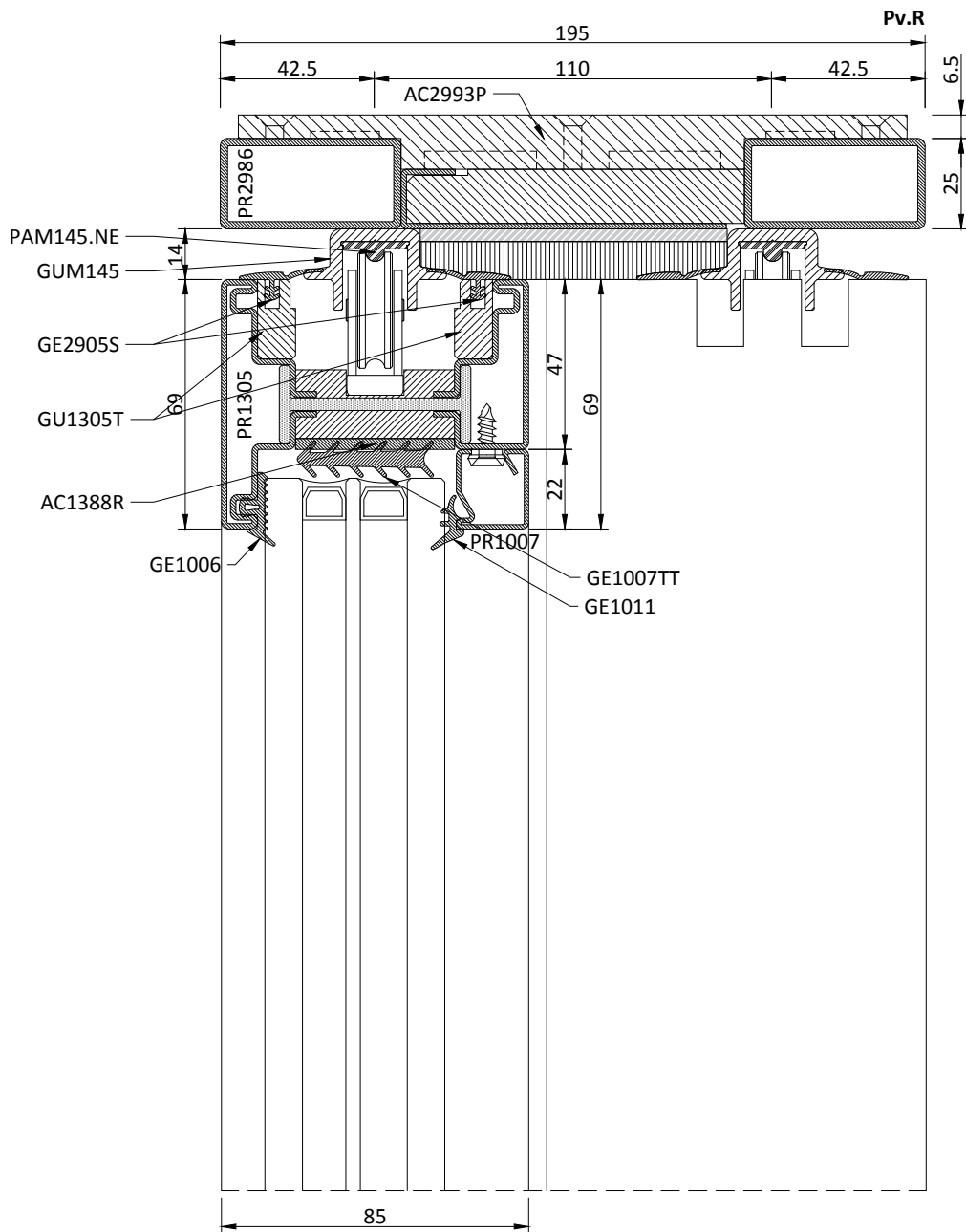
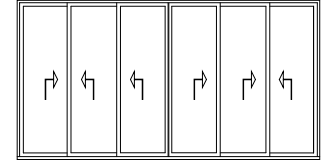

Schema | Type A

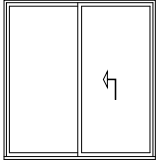

Schema | Type B

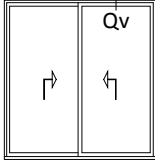

Schema | Type C

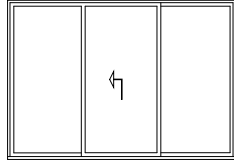

Schema | Type E

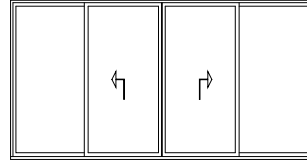

Schema | Type F

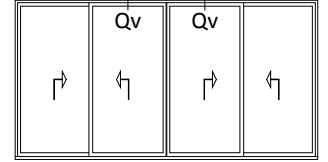

Schema | Type A3

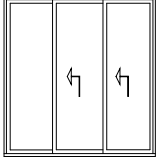

Schema | Type B3

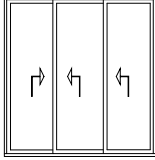

Schema | Type C3

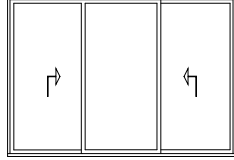

Schema | Type E3

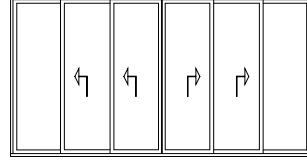

Schema | Type F3

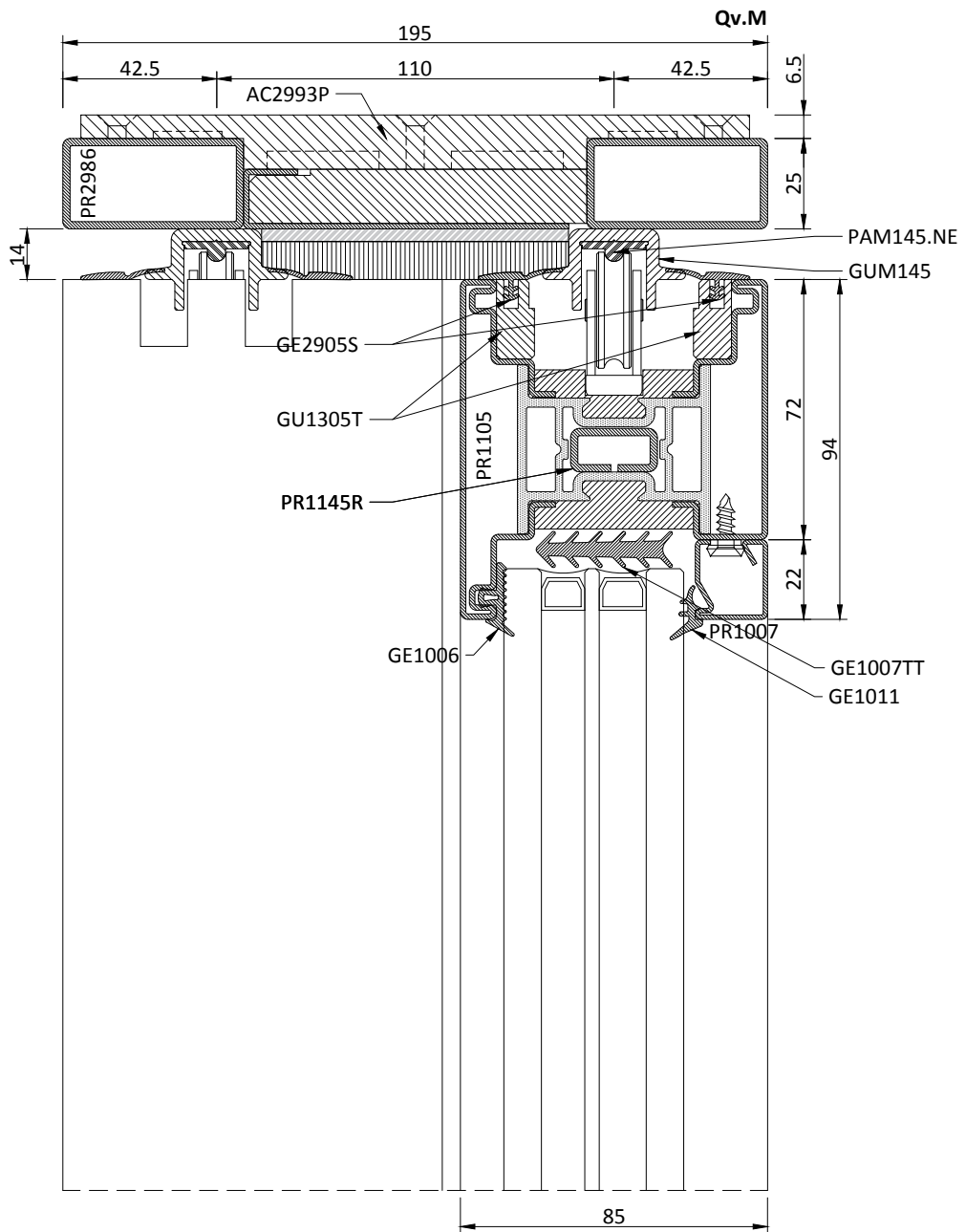
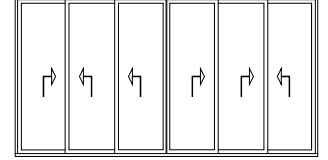

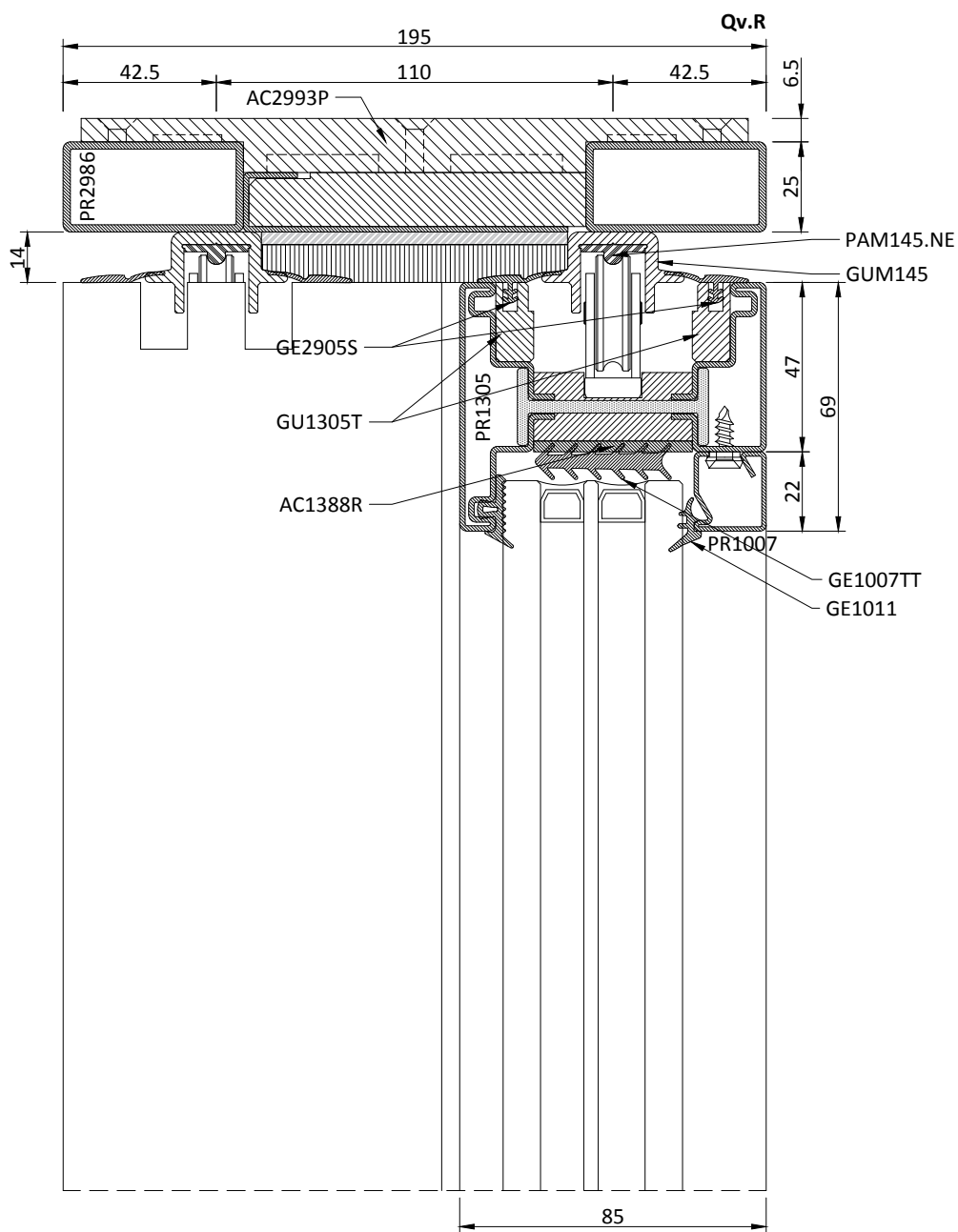
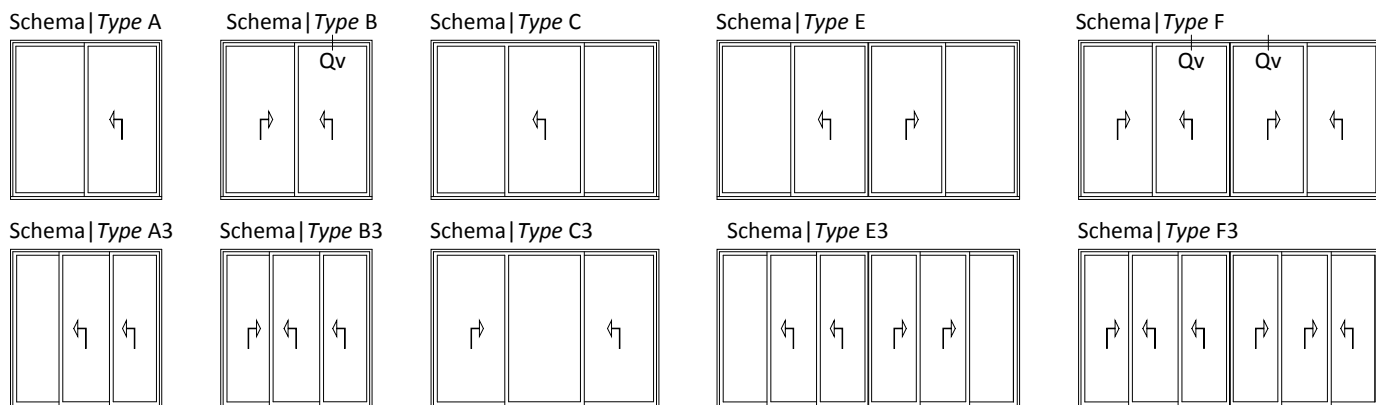

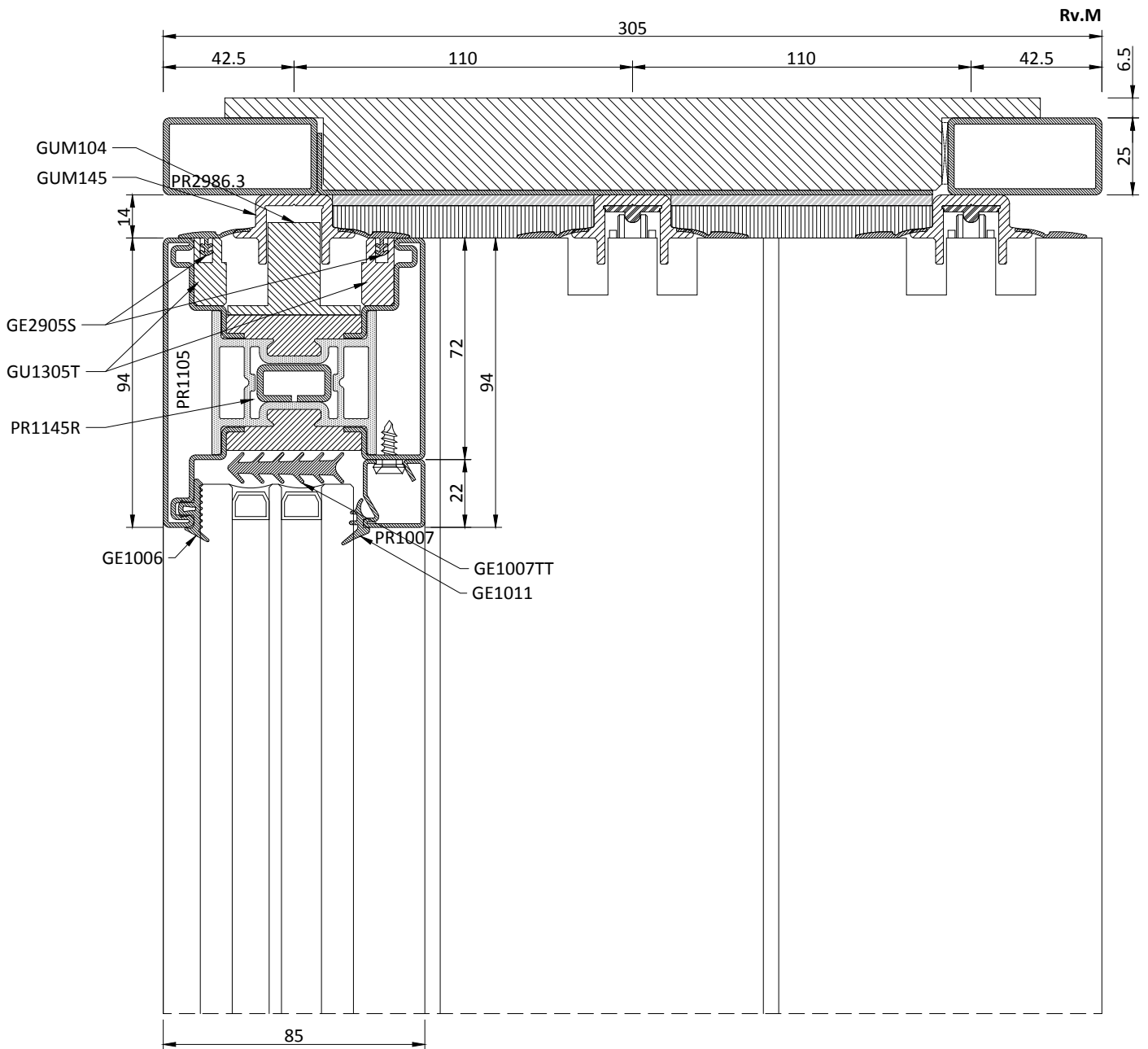
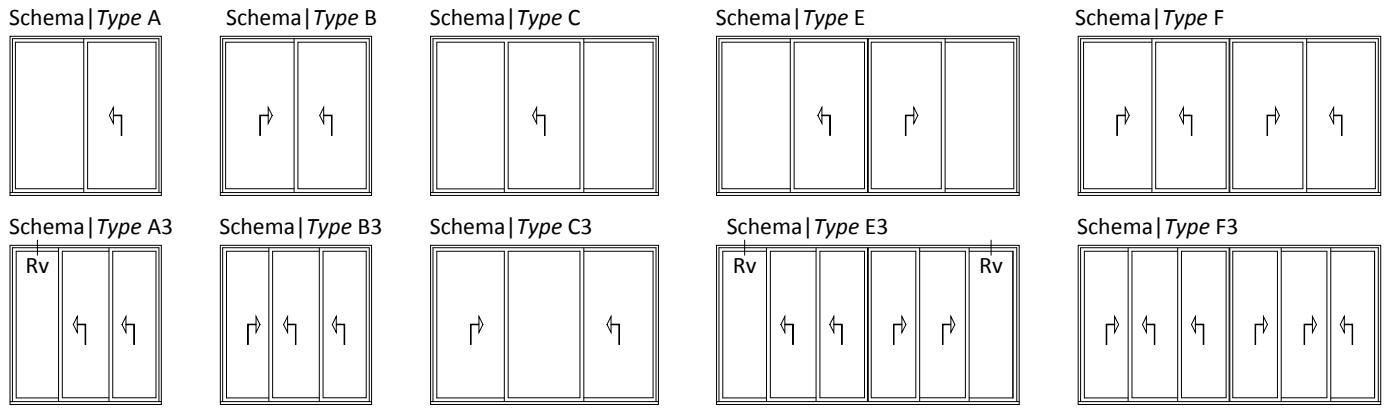

Schema | Type A

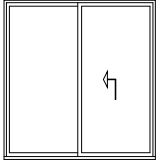

Schema | Type B

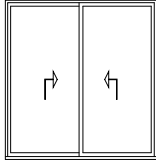

Schema | Type C

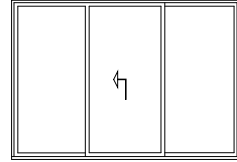

Schema | Type E

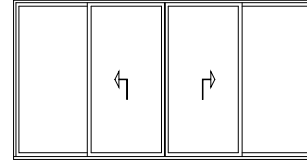

Schema | Type F

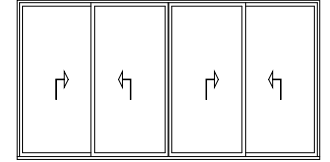

Schema | Type A3

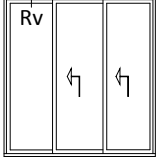

Schema | Type B3

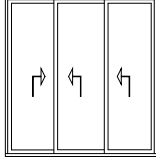

Schema | Type C3

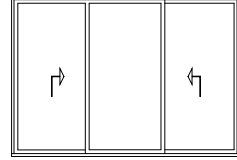

Schema | Type E3

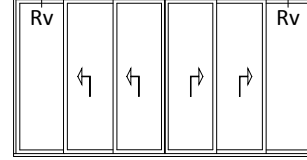

Schema | Type F3

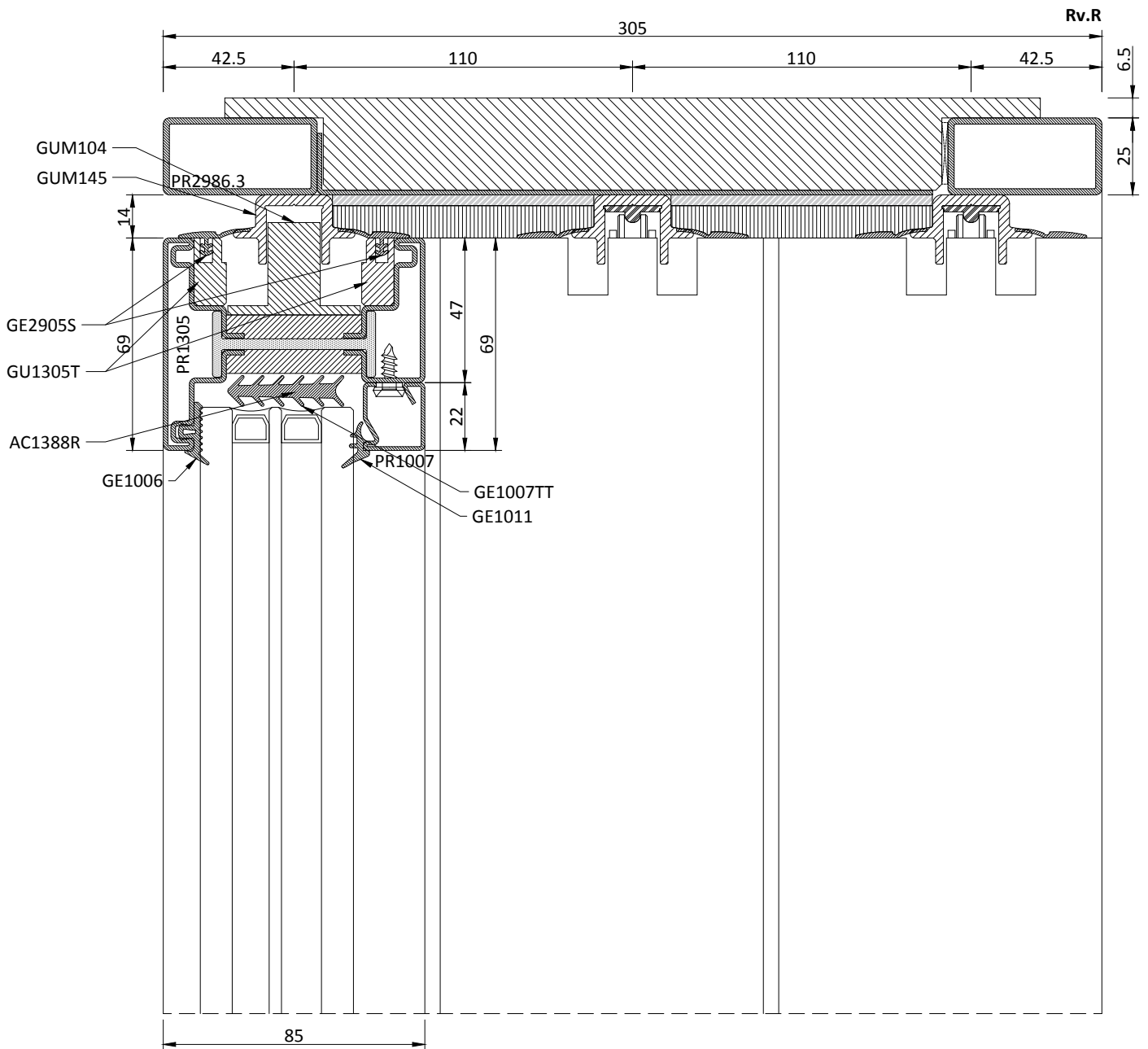
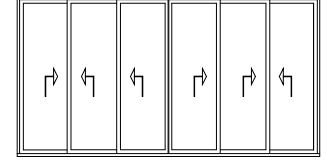



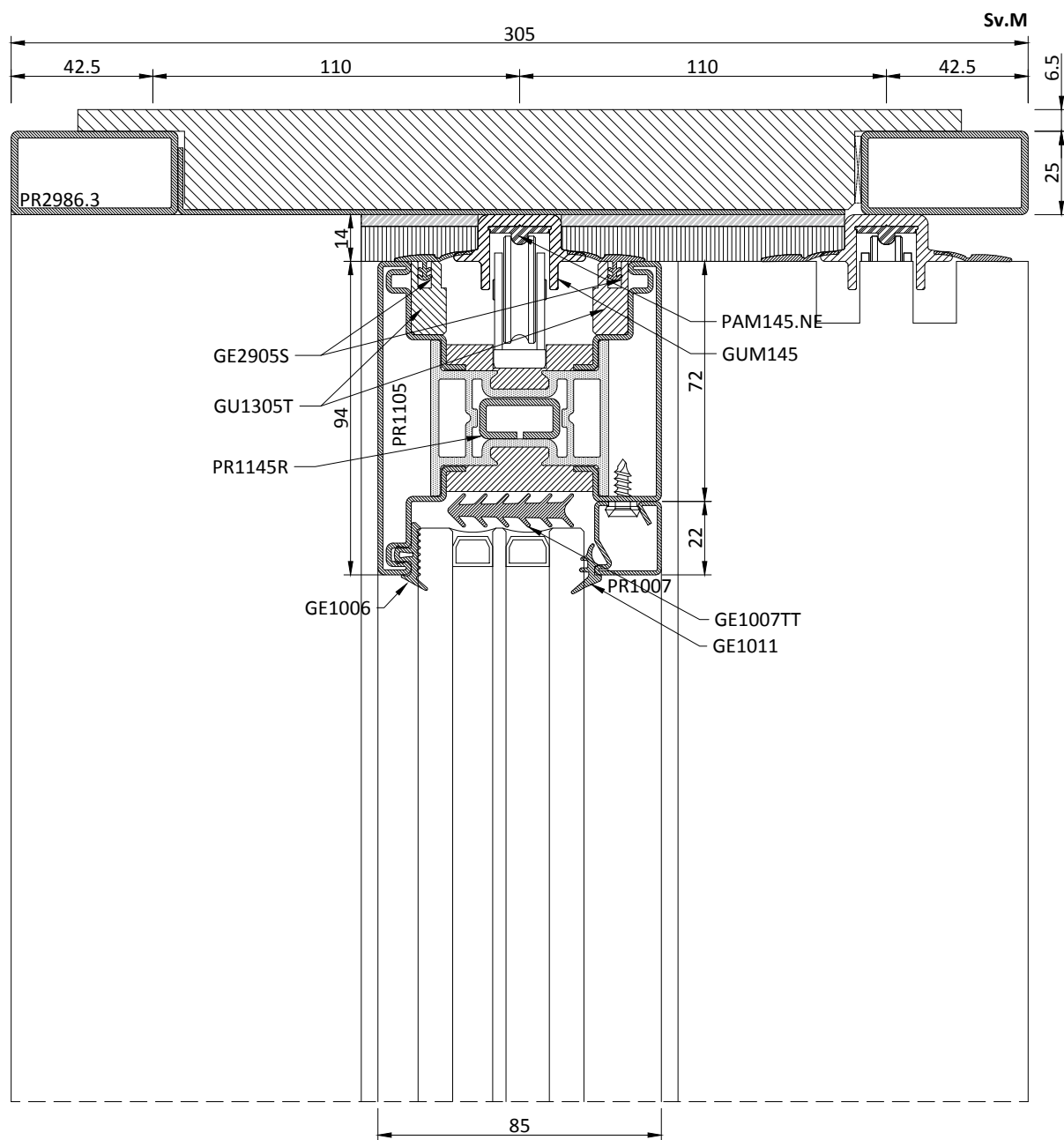
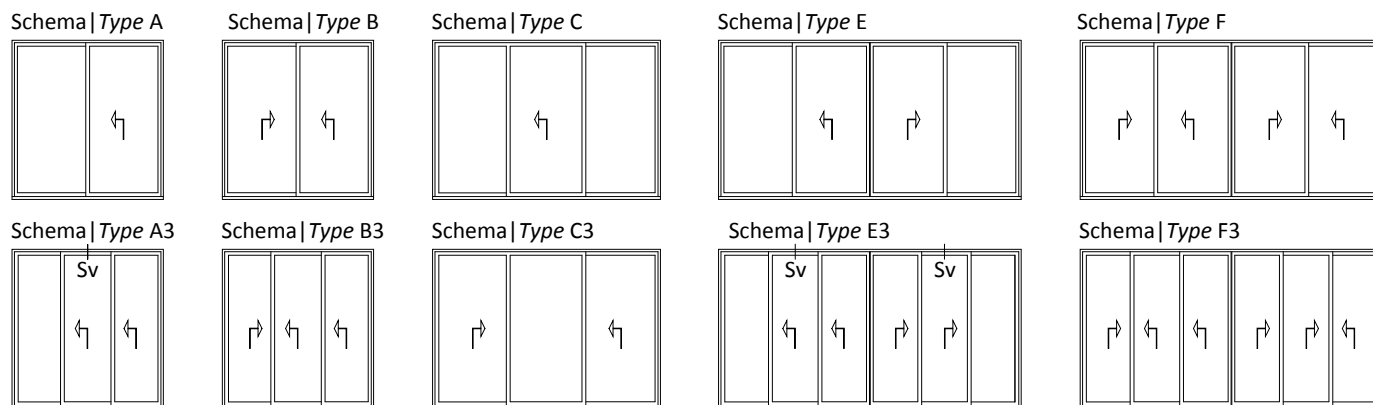

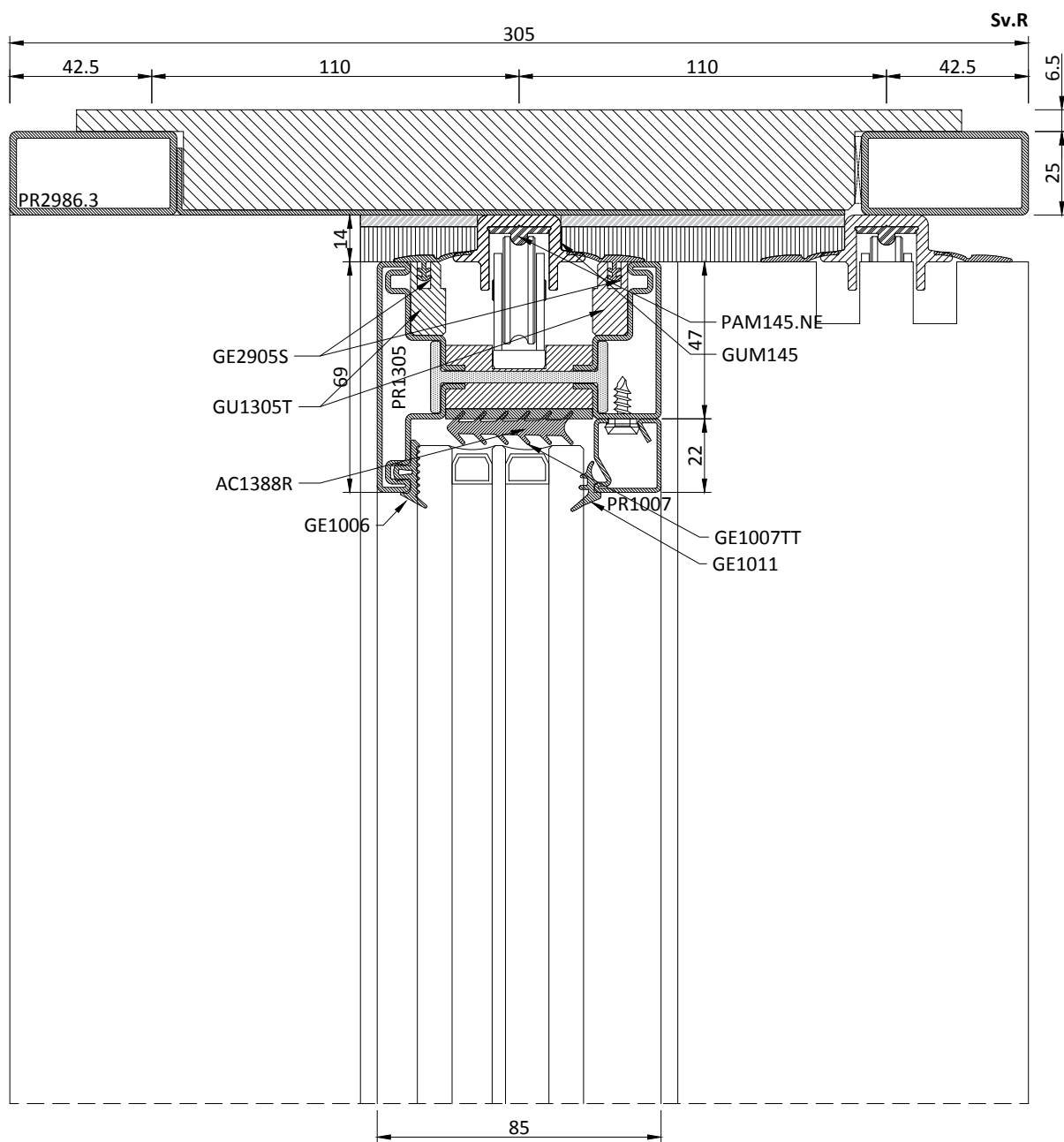
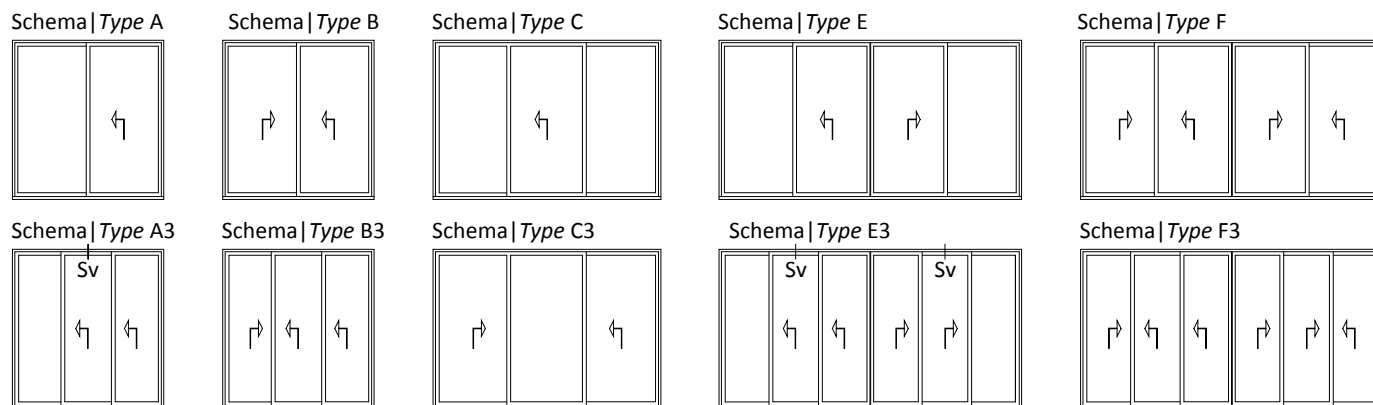

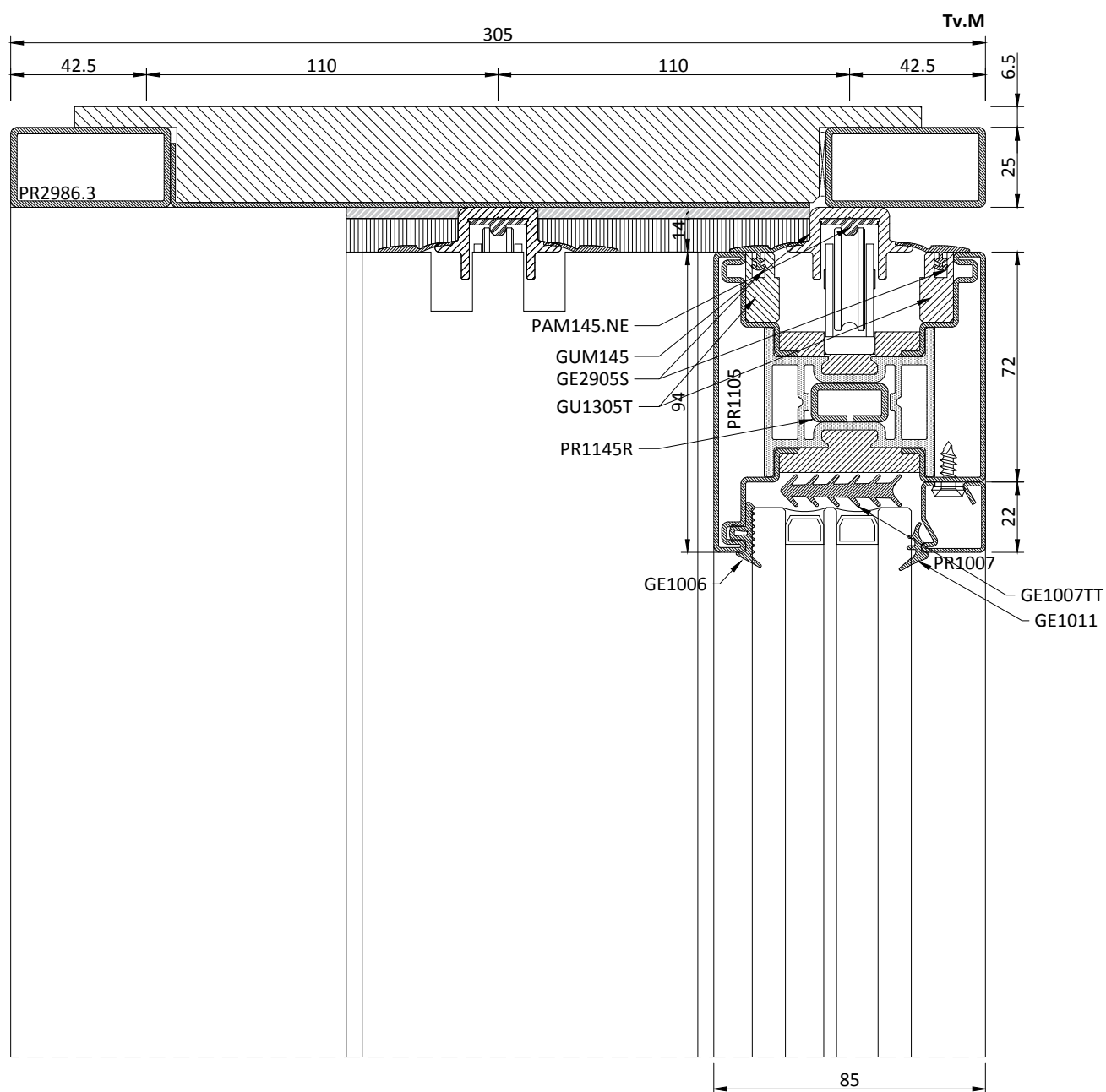
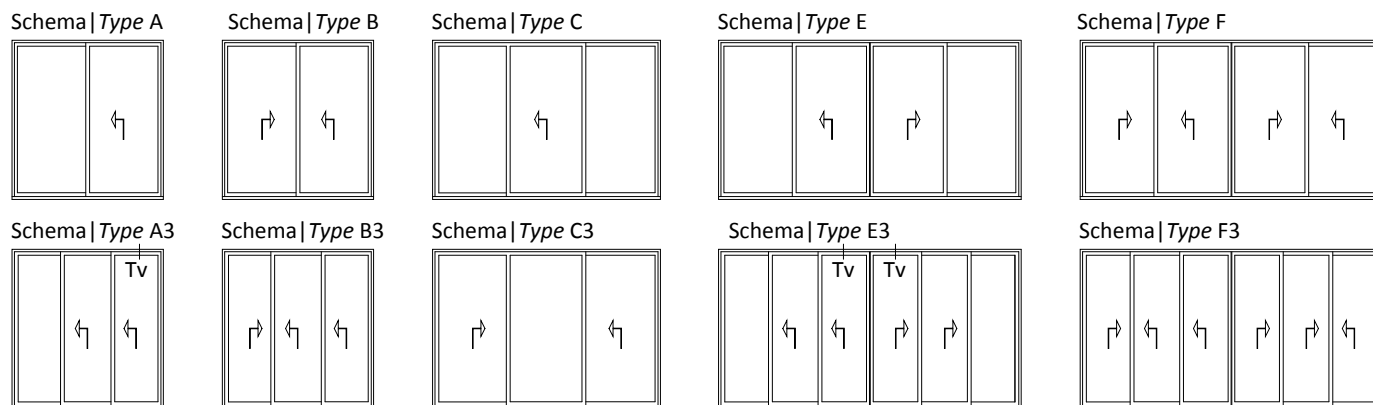

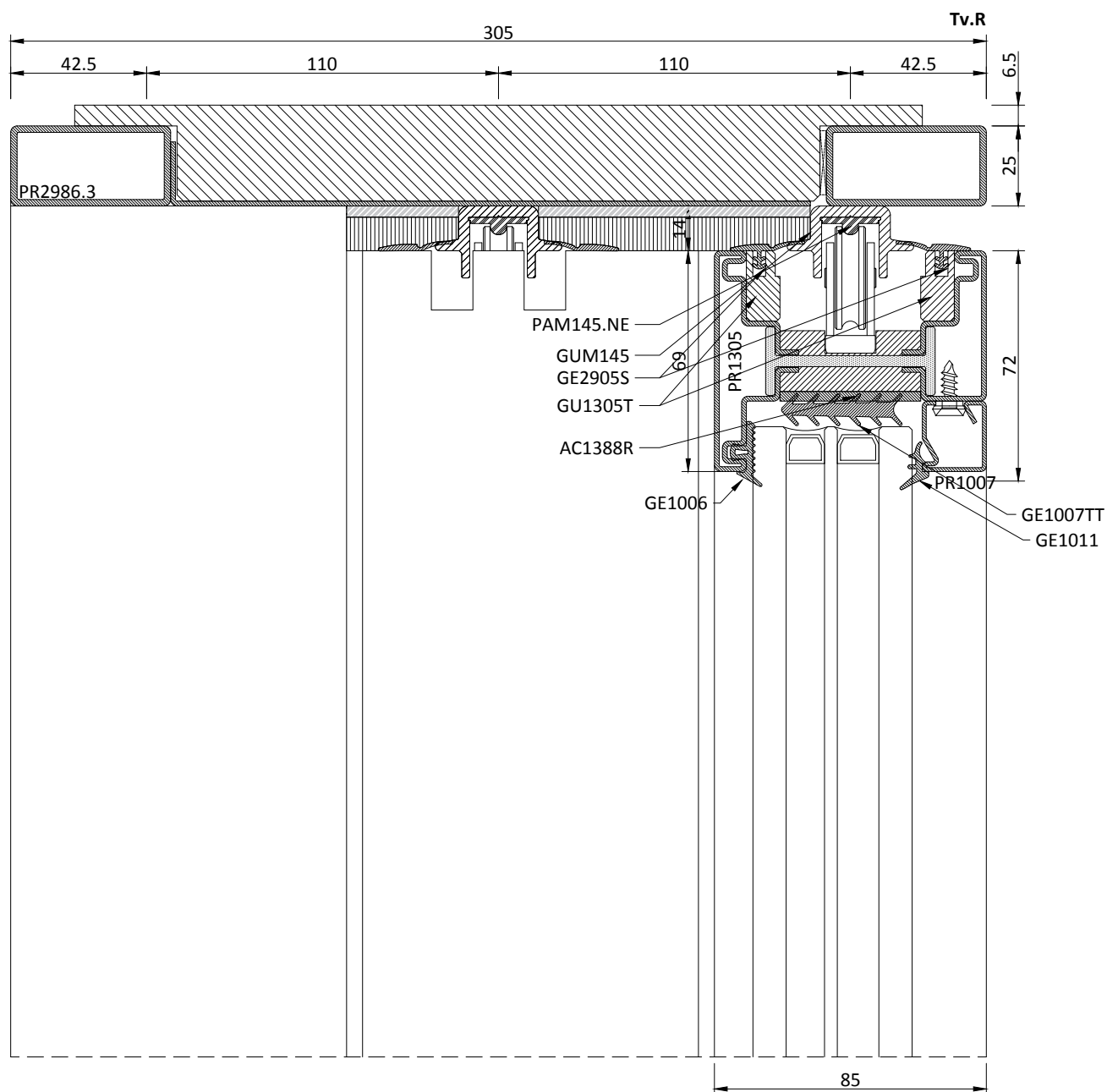
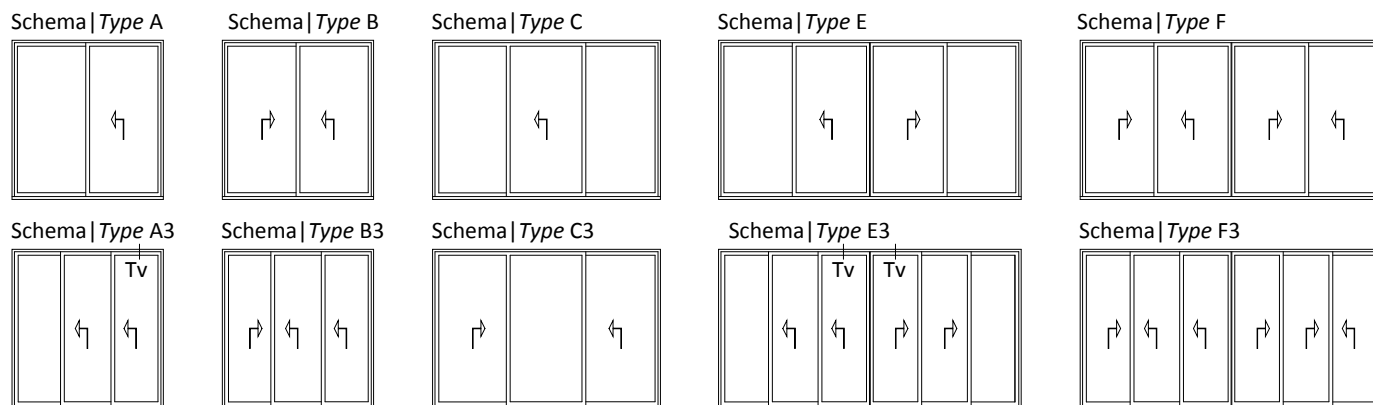

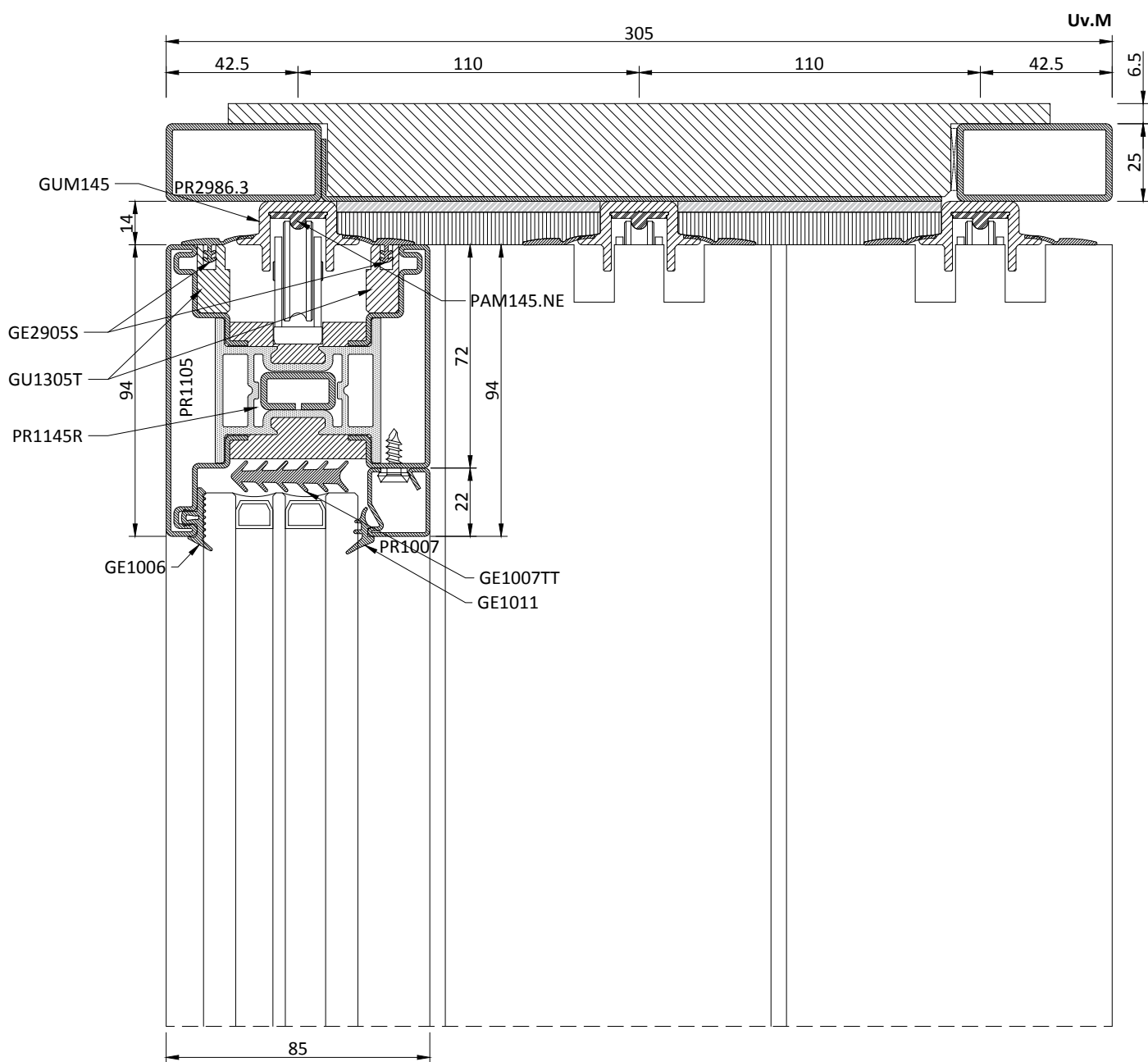
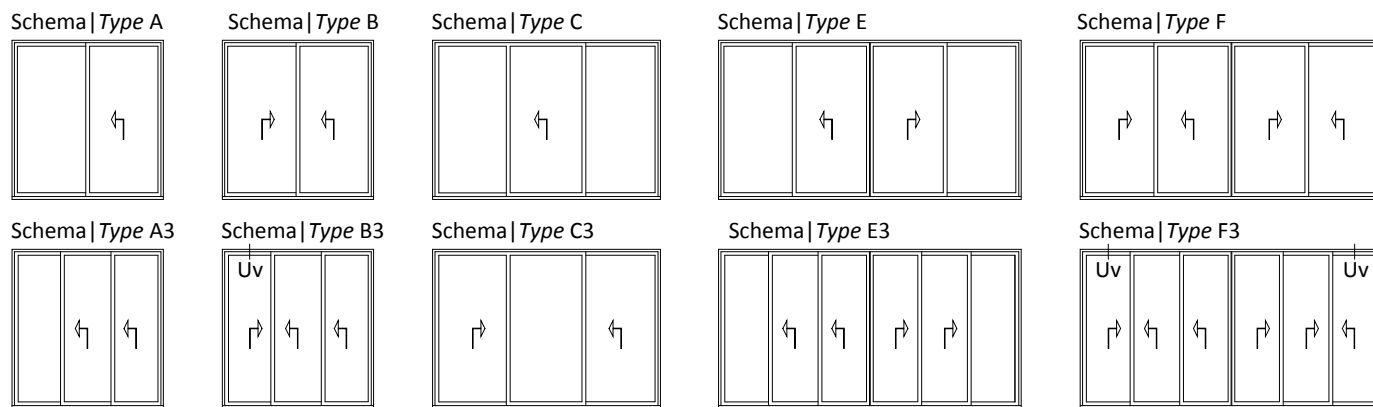

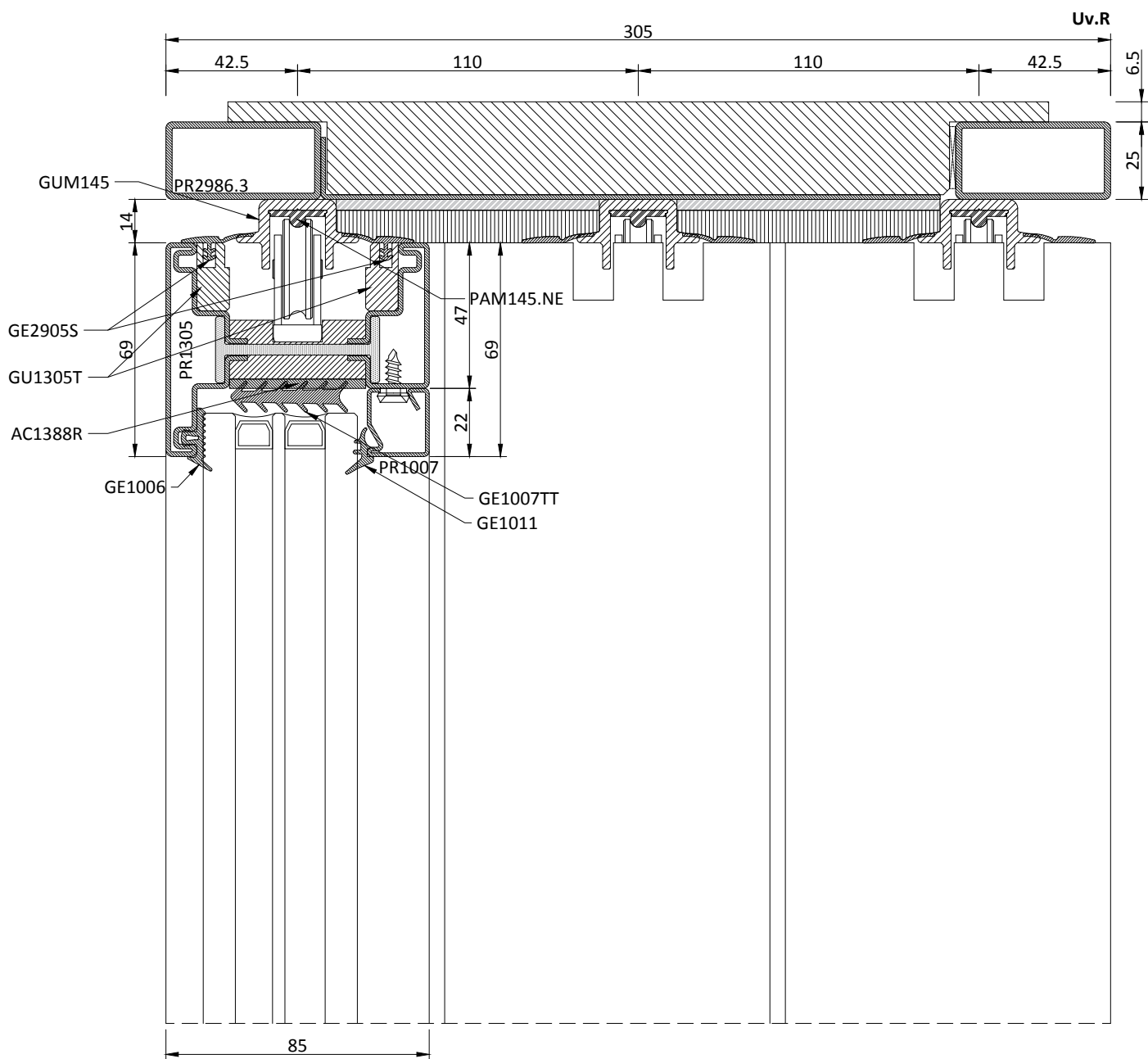
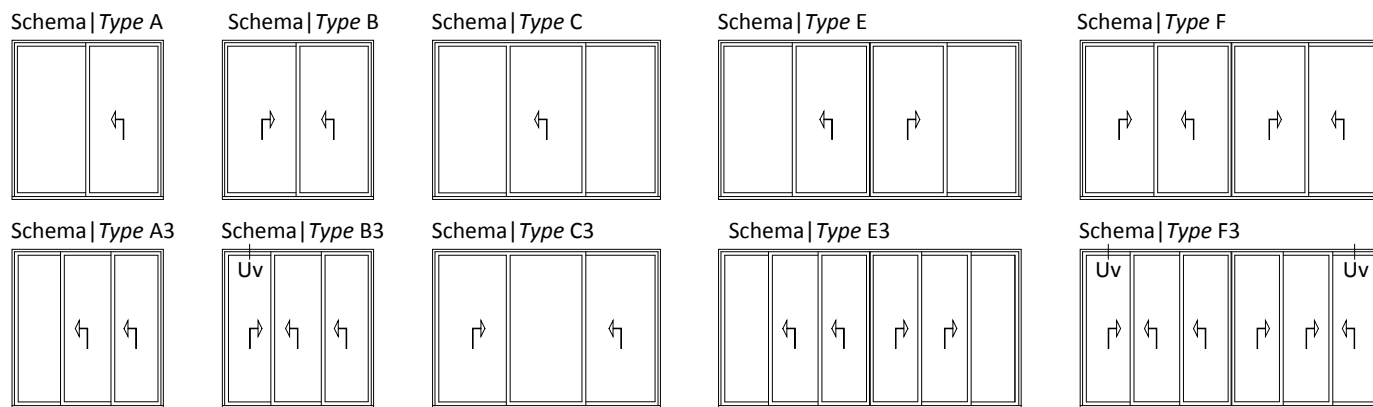

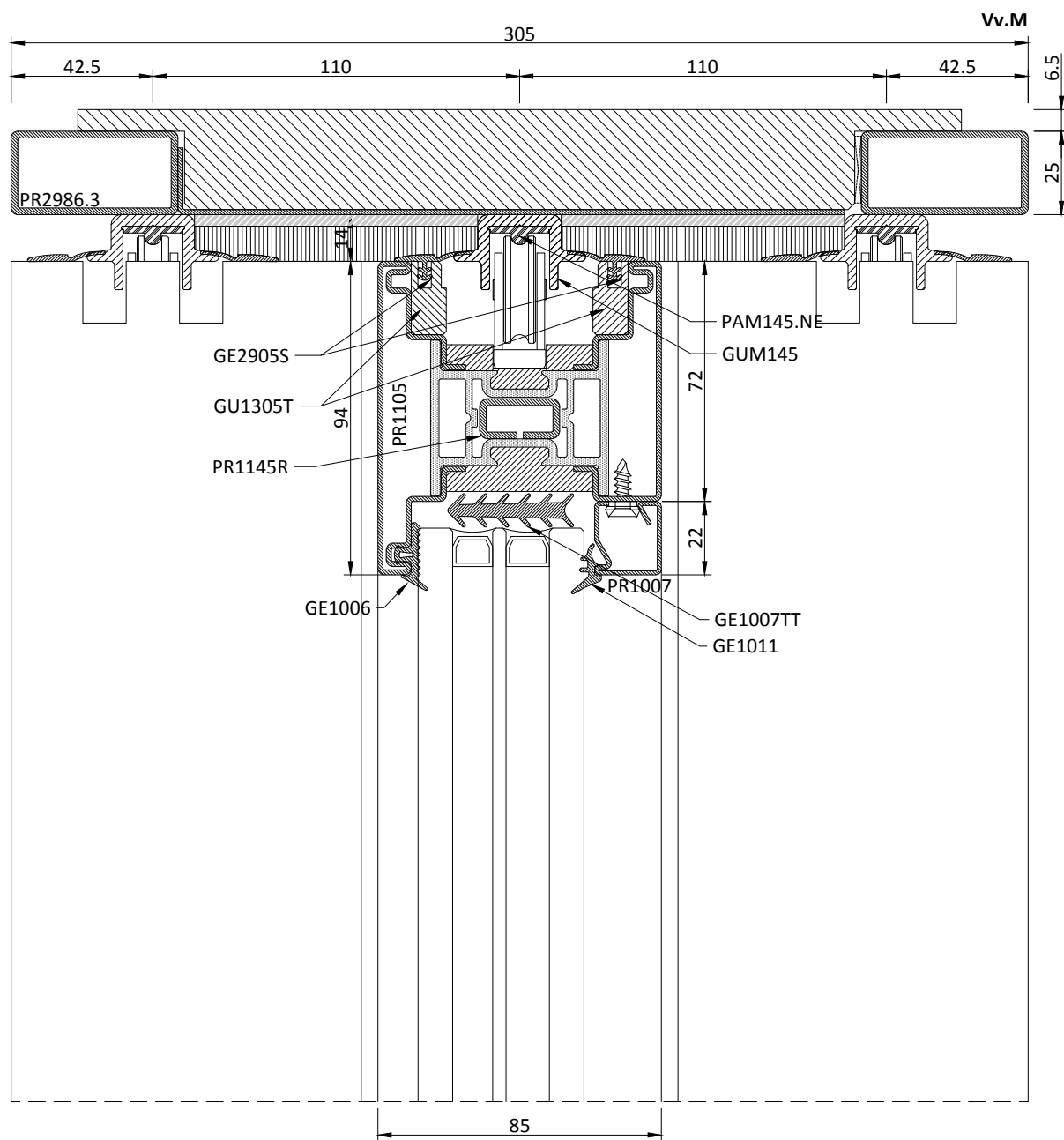
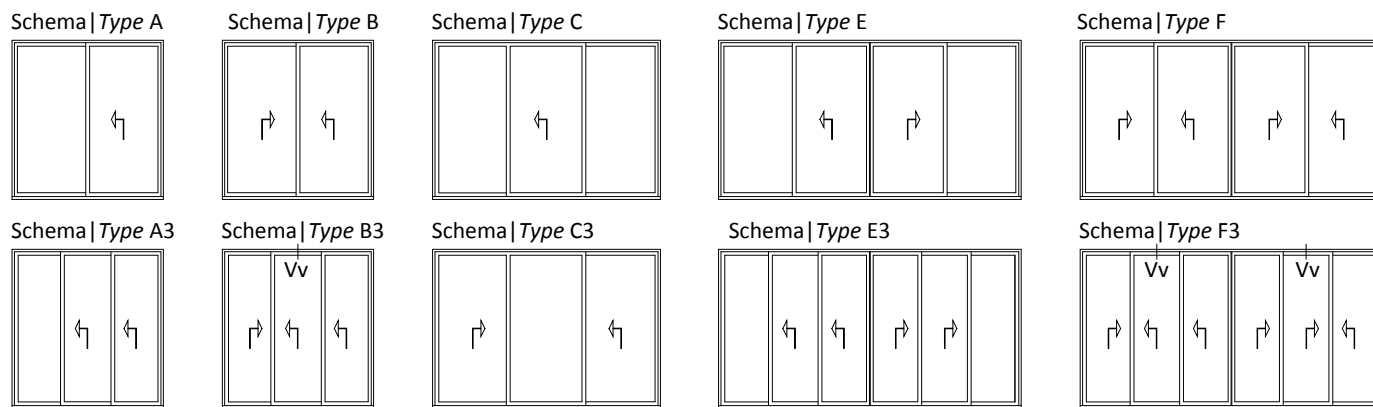

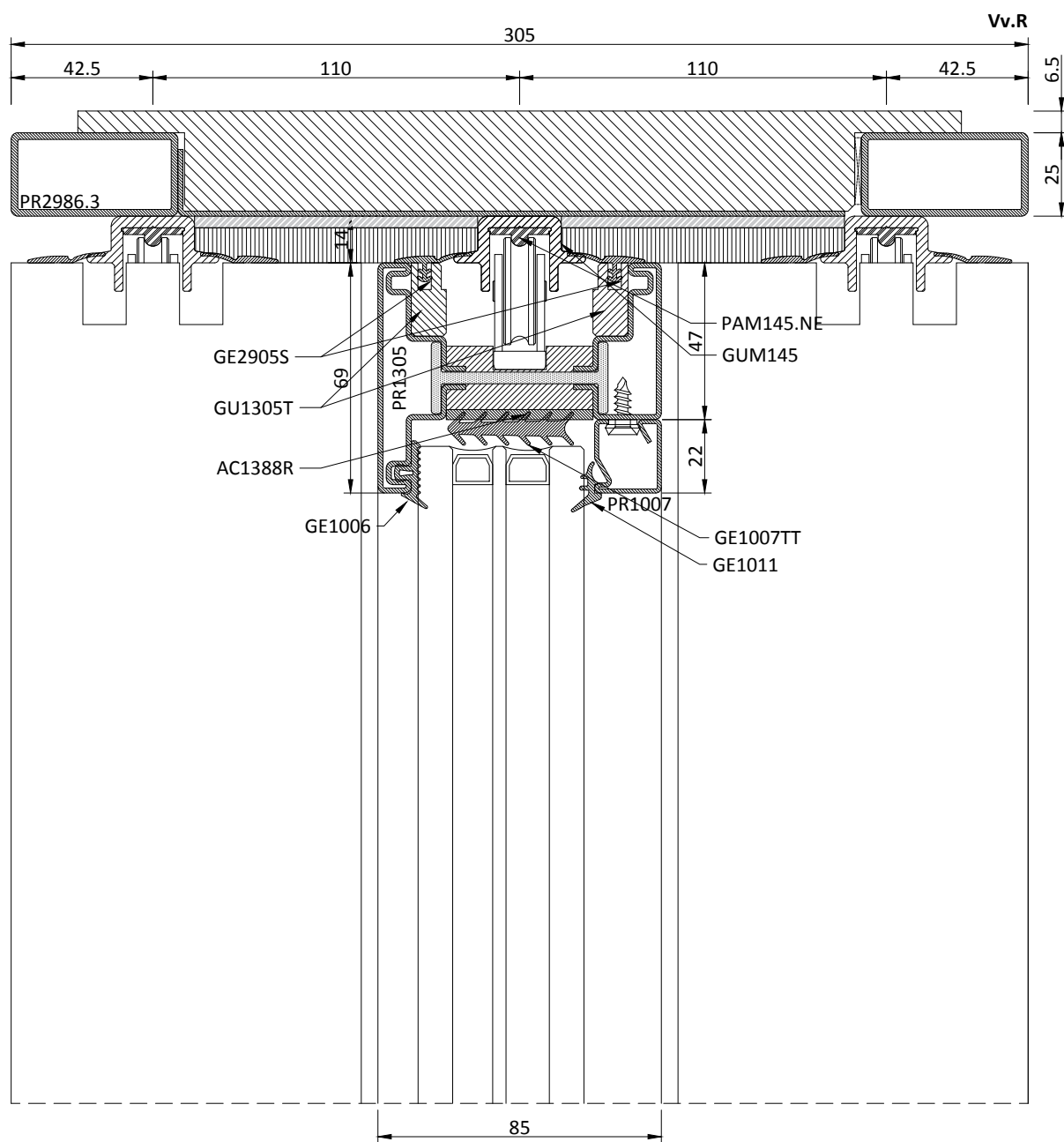
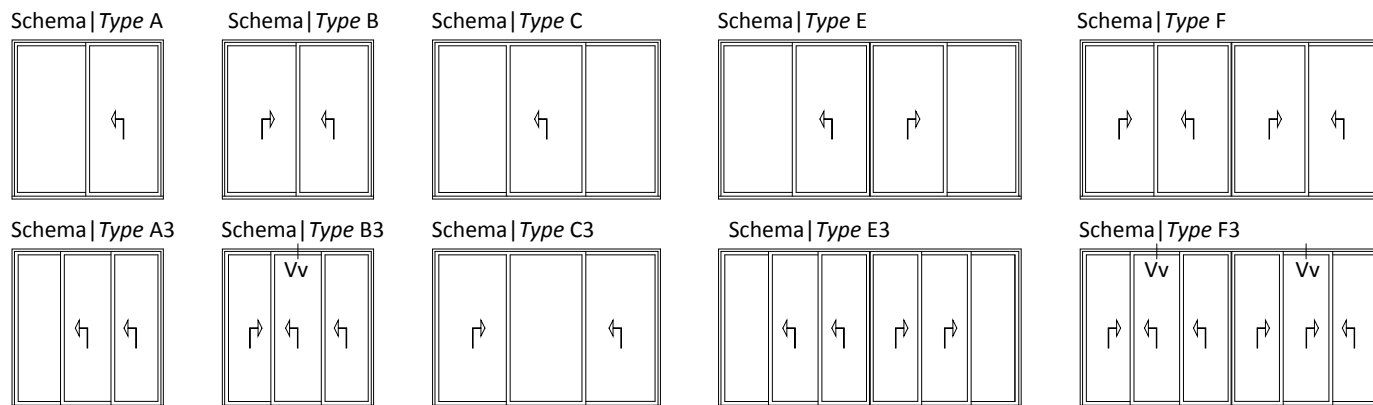



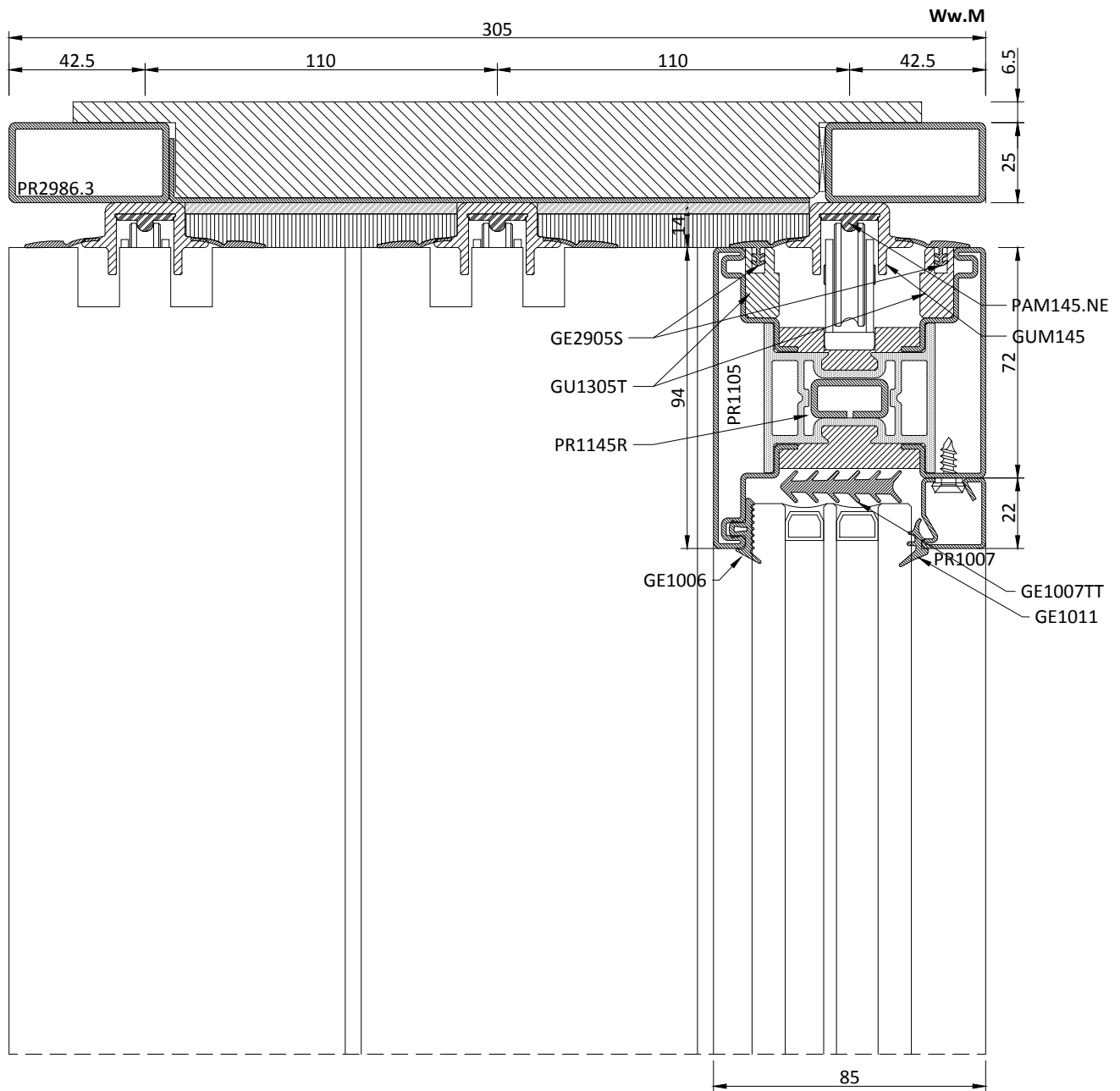
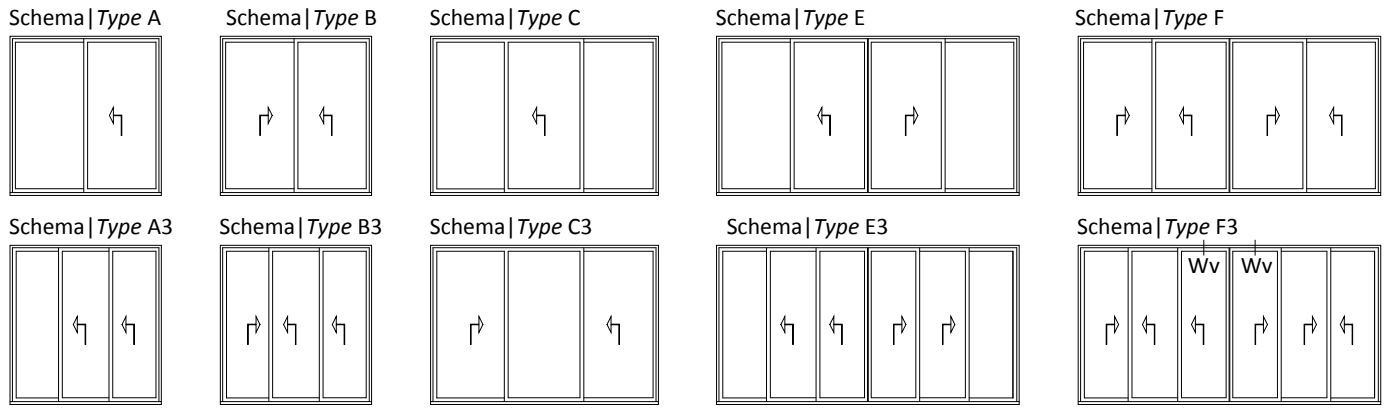

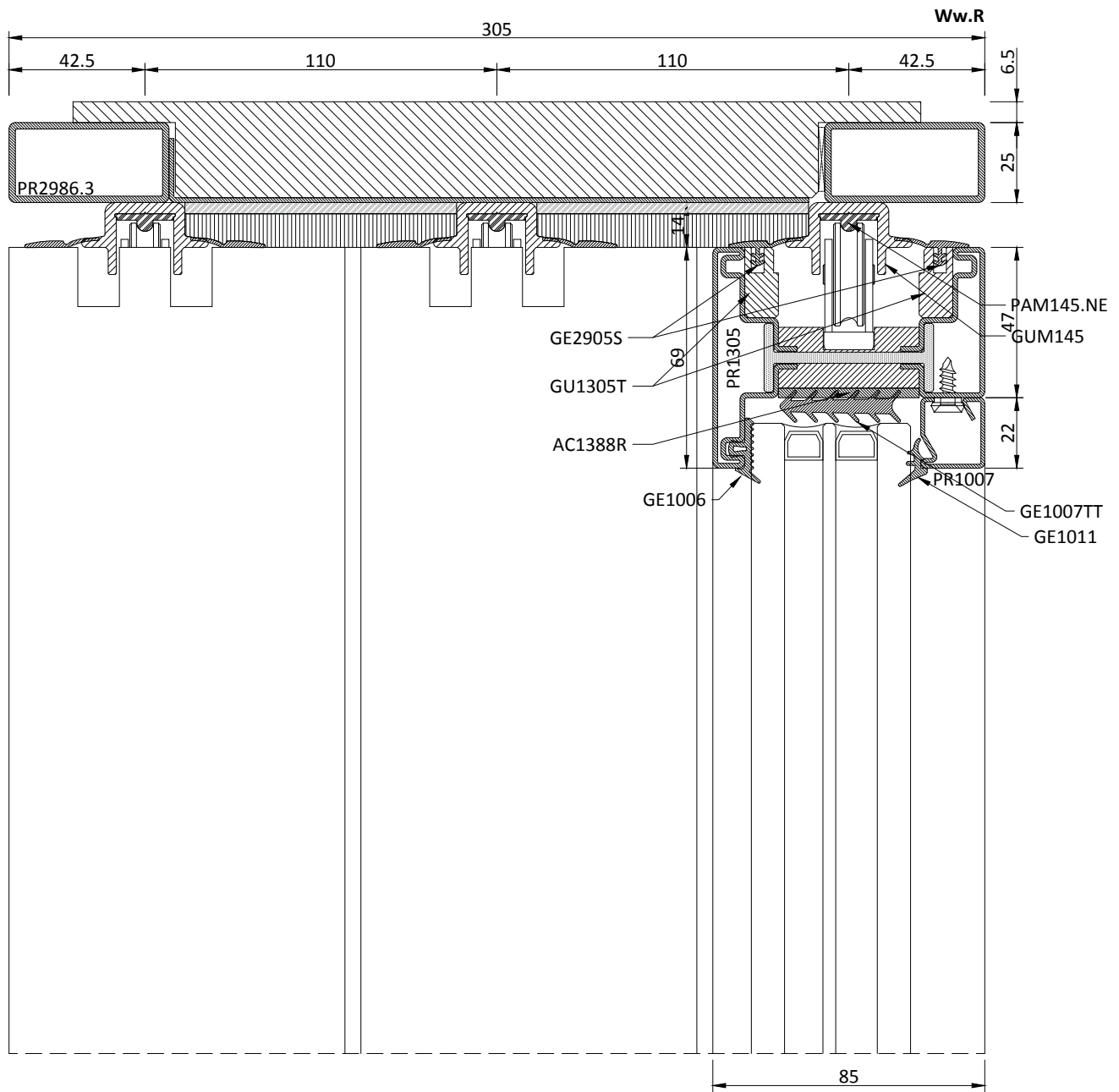
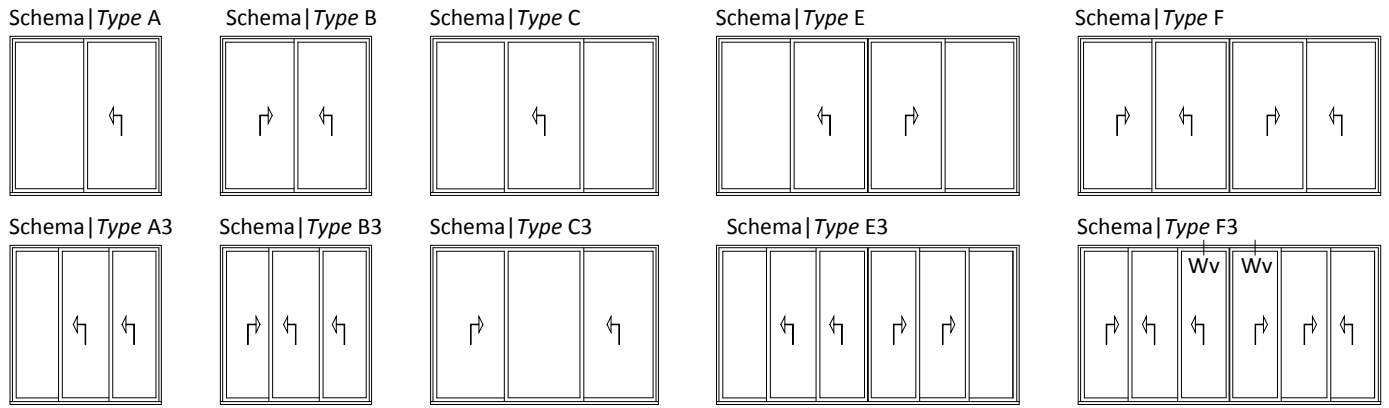

Schema | Type A

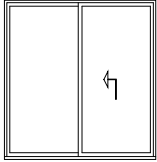

Schema | Type B

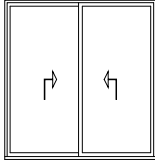

Schema | Type C

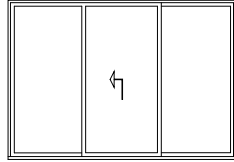

Schema | Type E

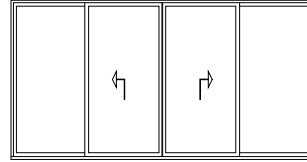

Schema | Type F

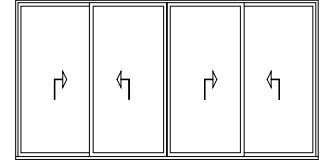

Schema | Type A3

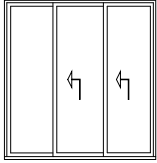

Schema | Type B3

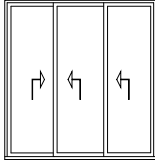

Schema | Type C3

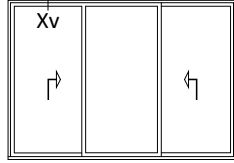

Schema | Type E3

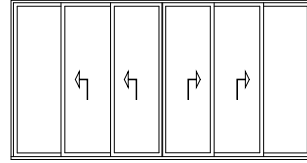

Schema | Type F3

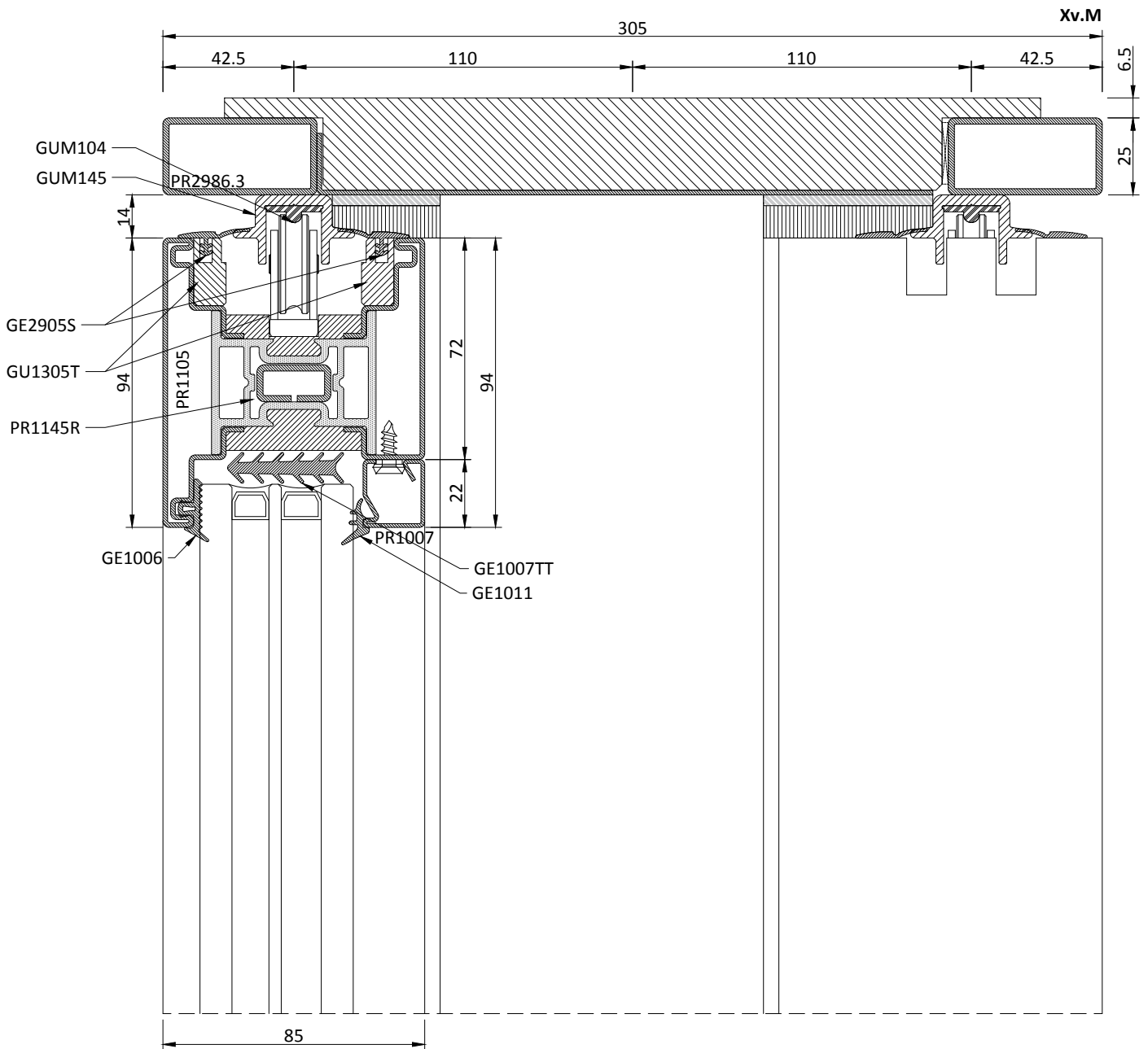
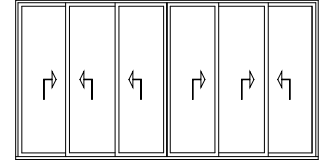

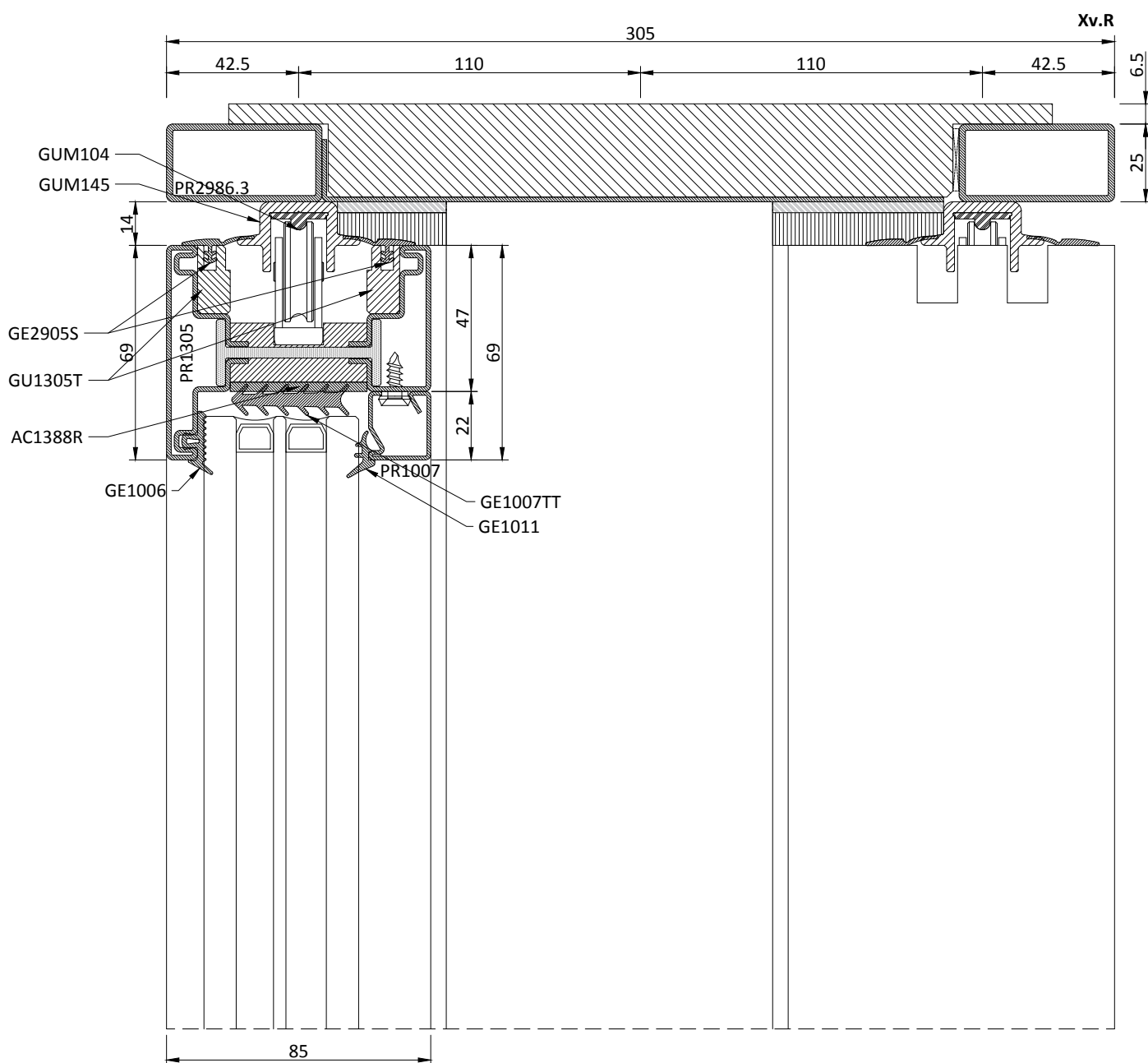
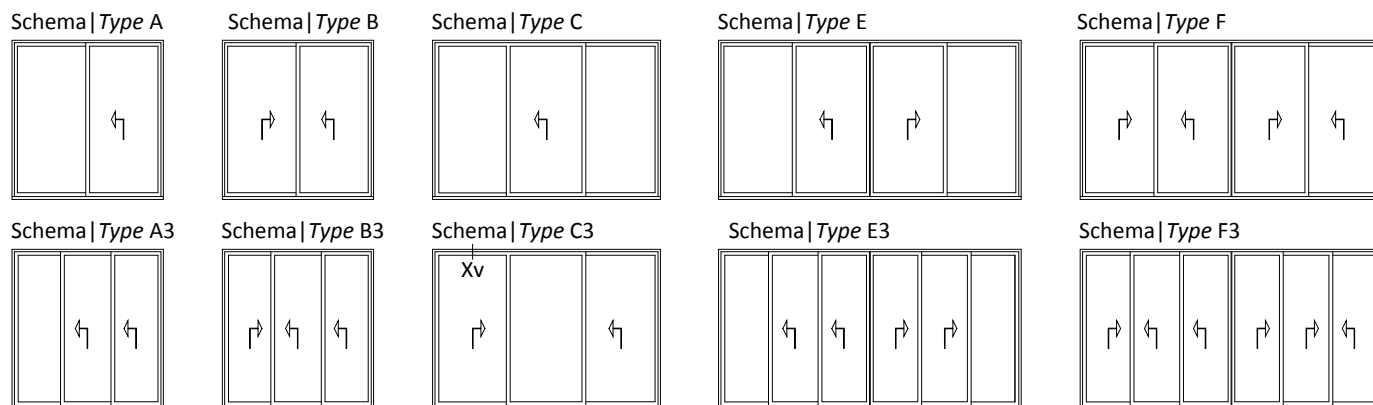

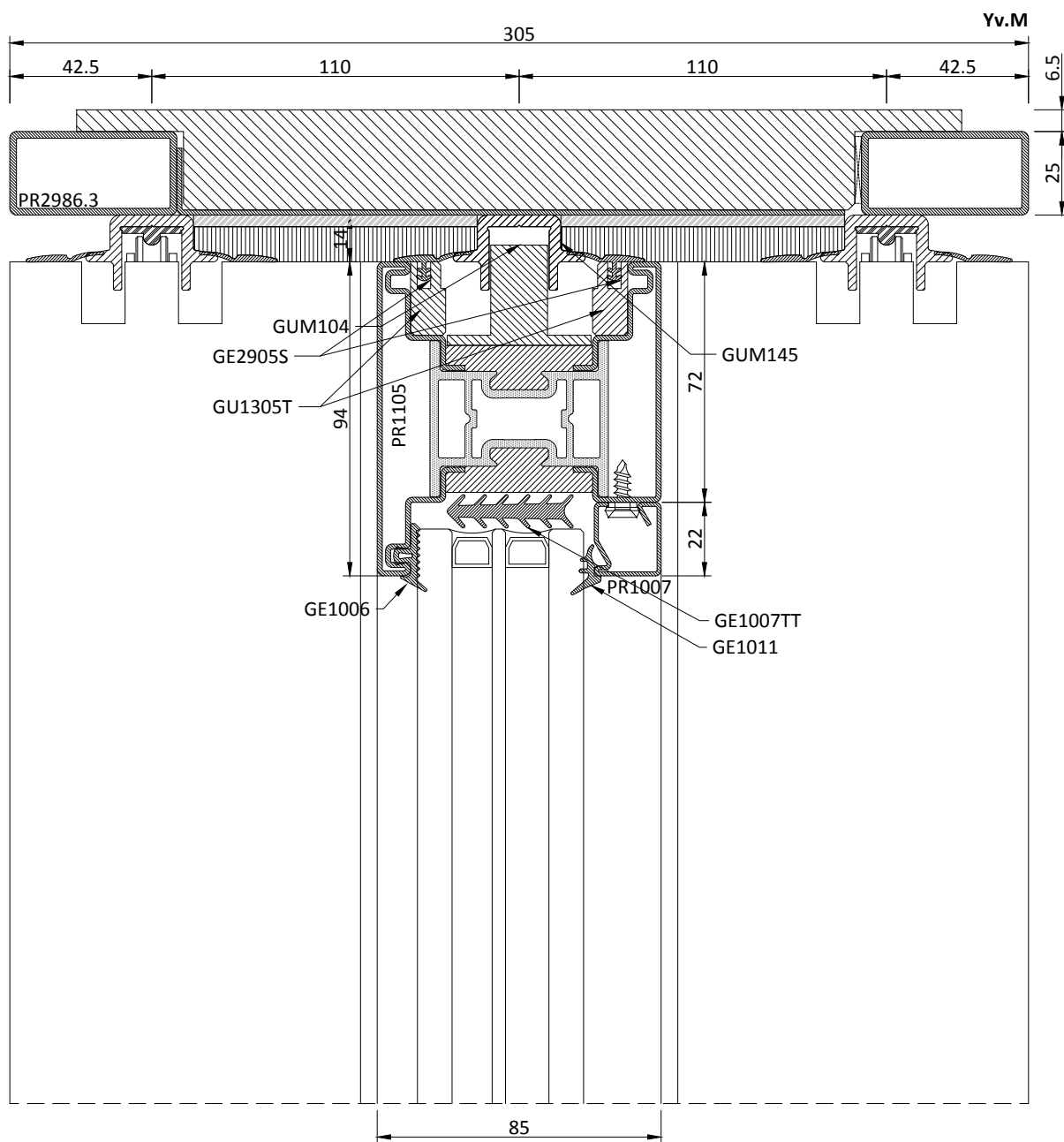
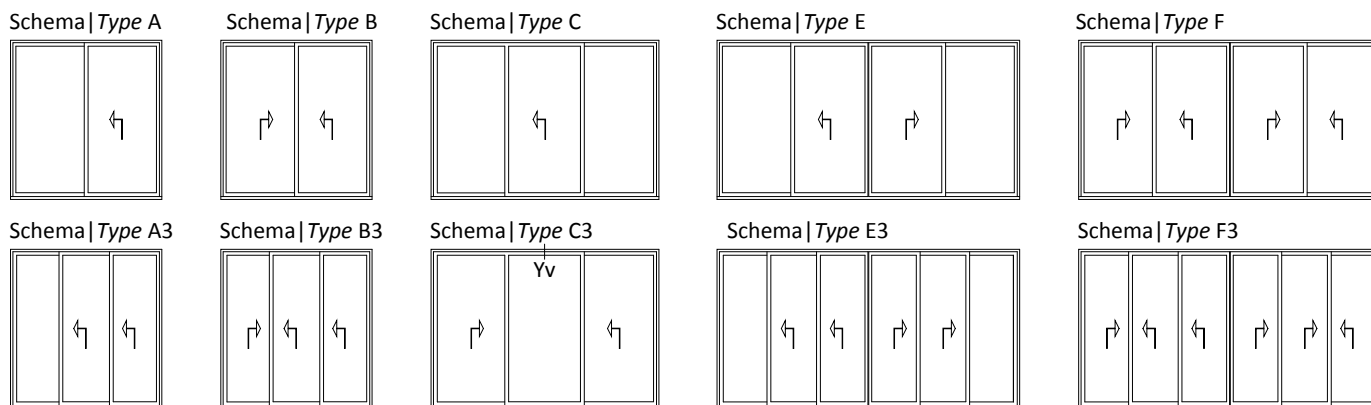

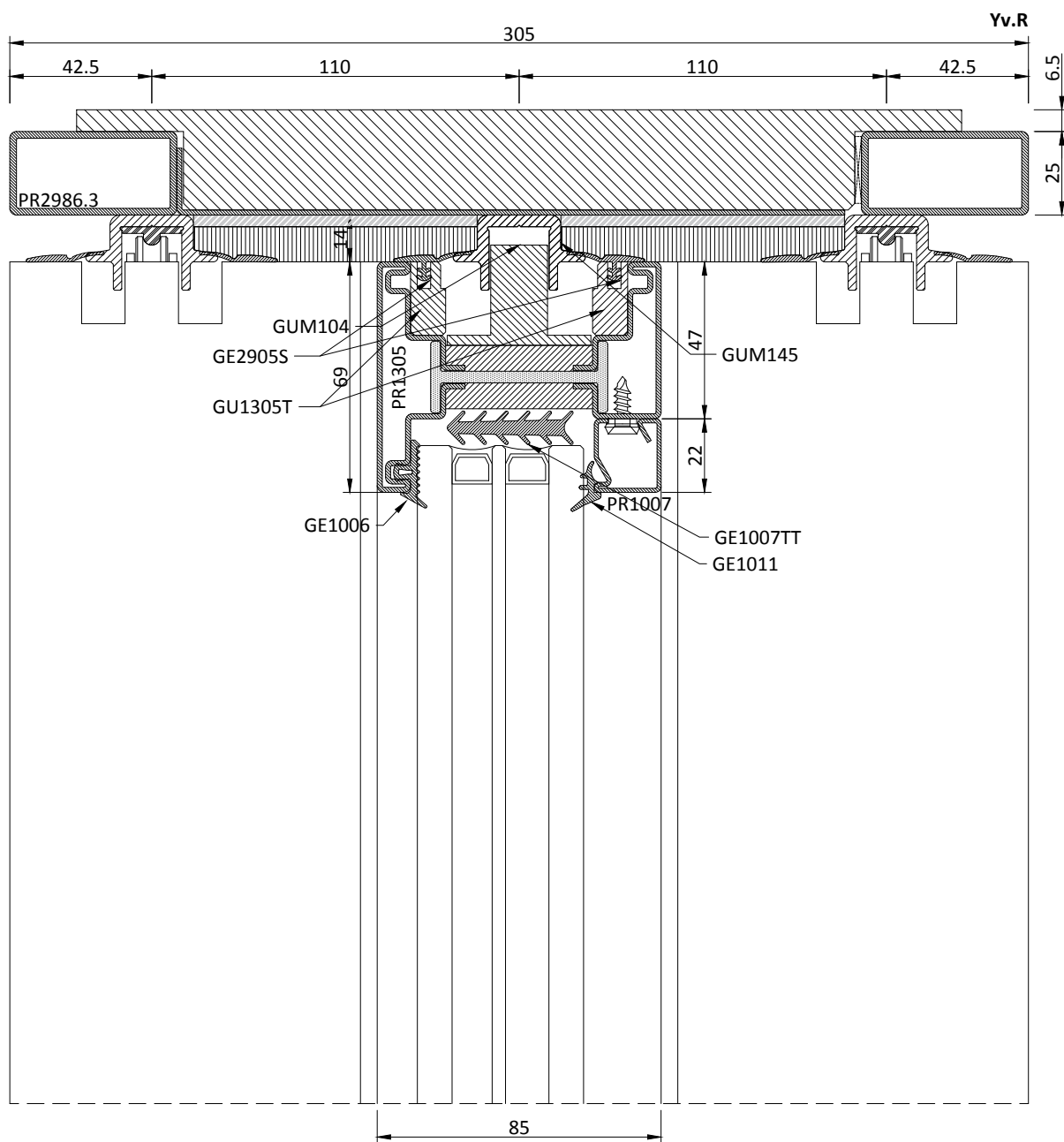
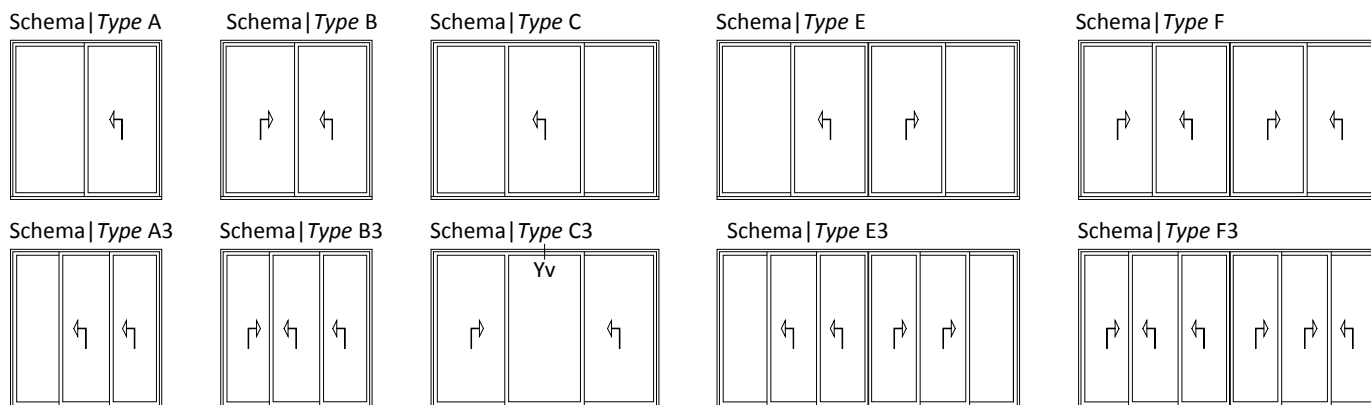

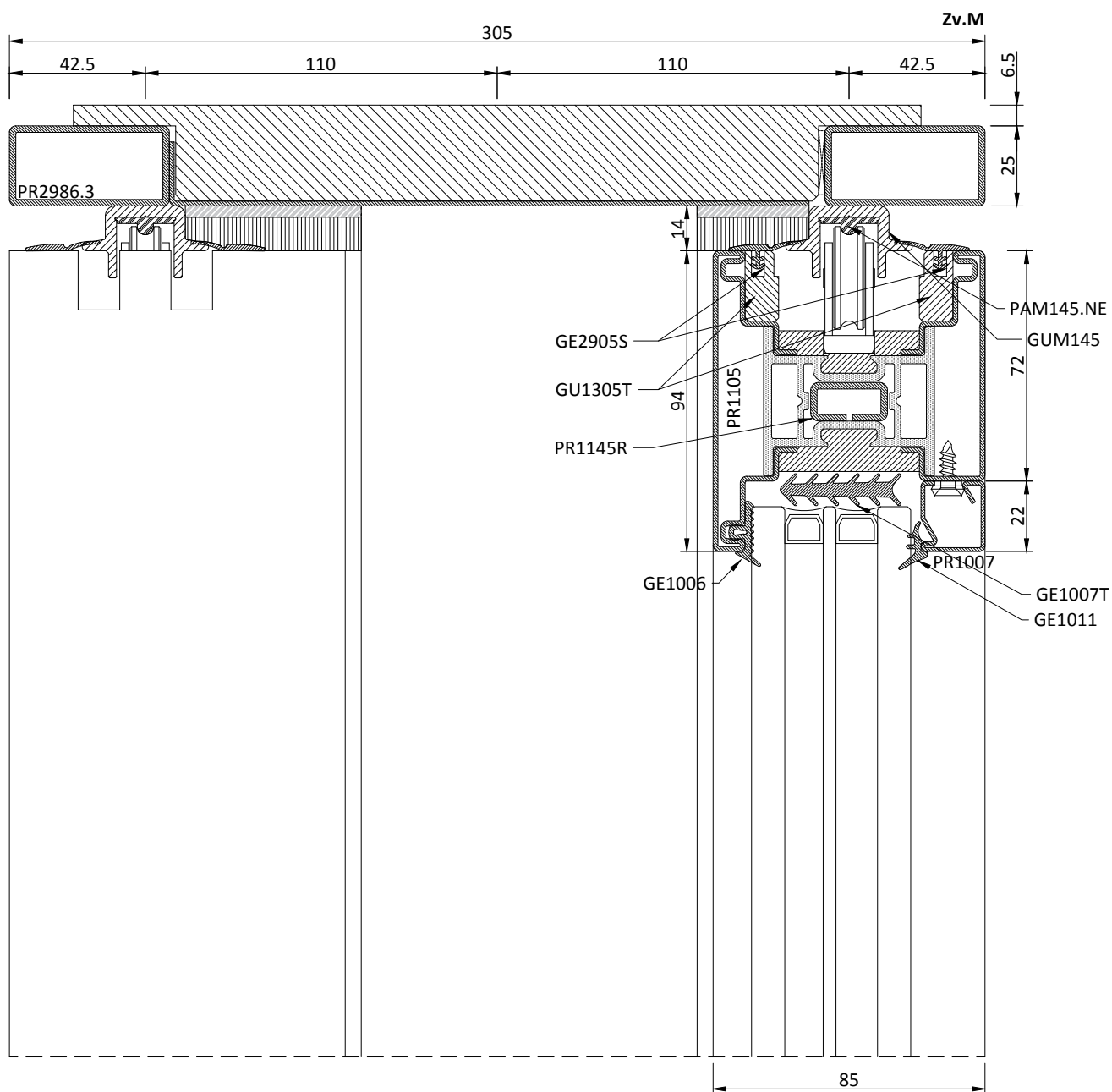
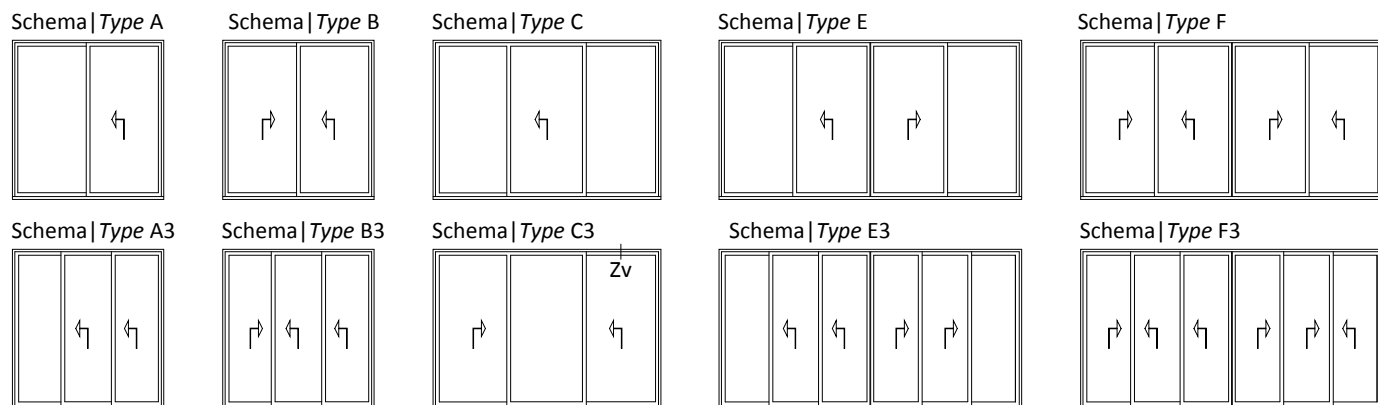

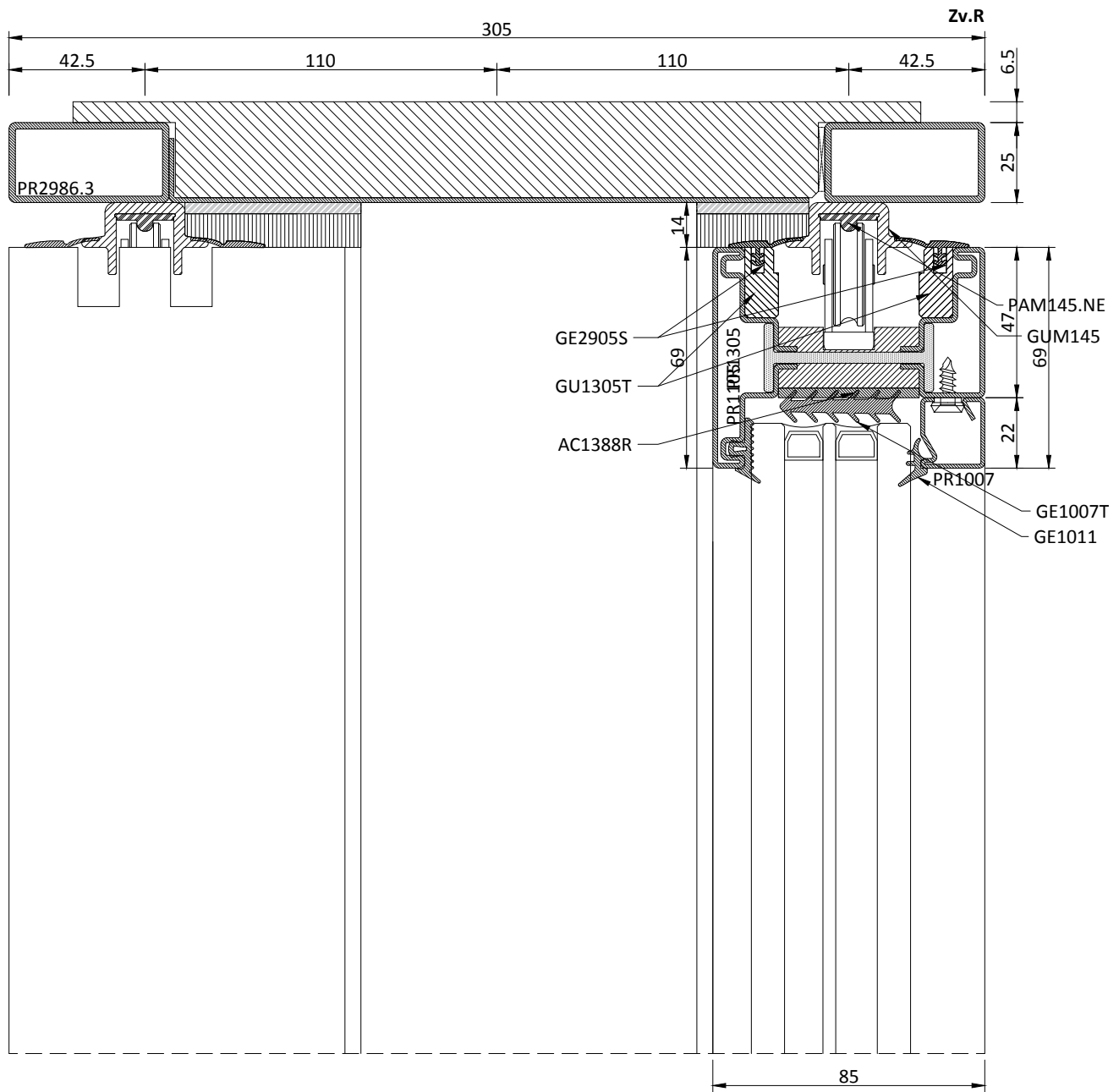
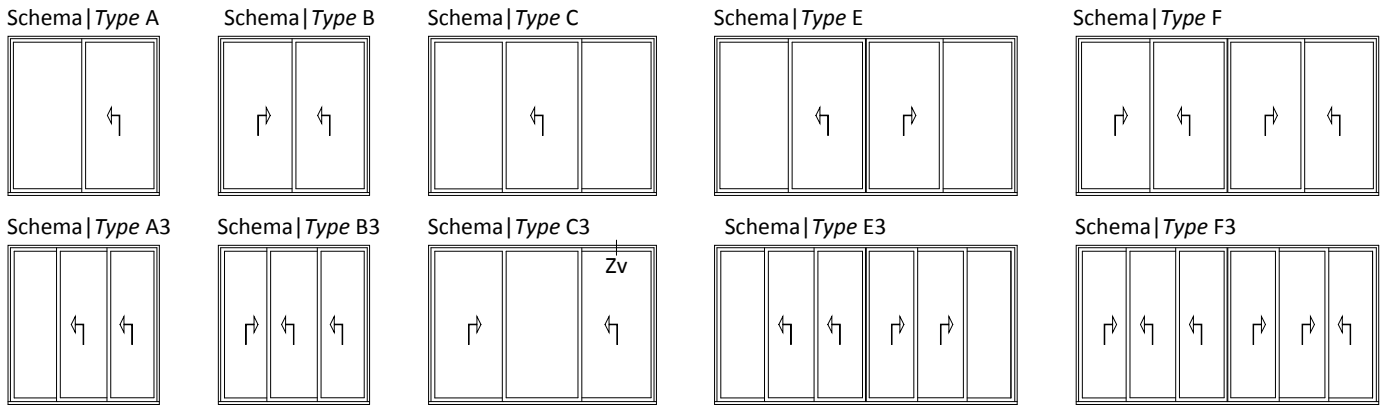



Schema | Type S1

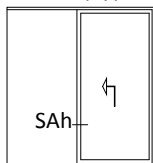

Schema | Type S2

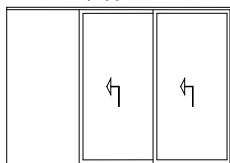

Schema | Type S3

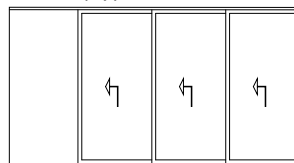

Schema | Type T1

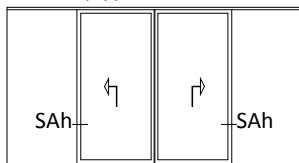

Schema | Type T2

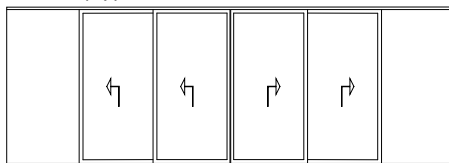

Schema | Type T3

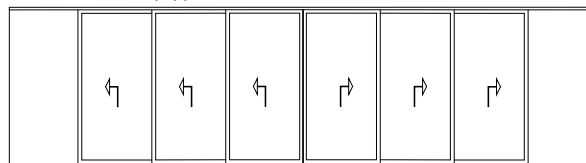

**SAh.M**

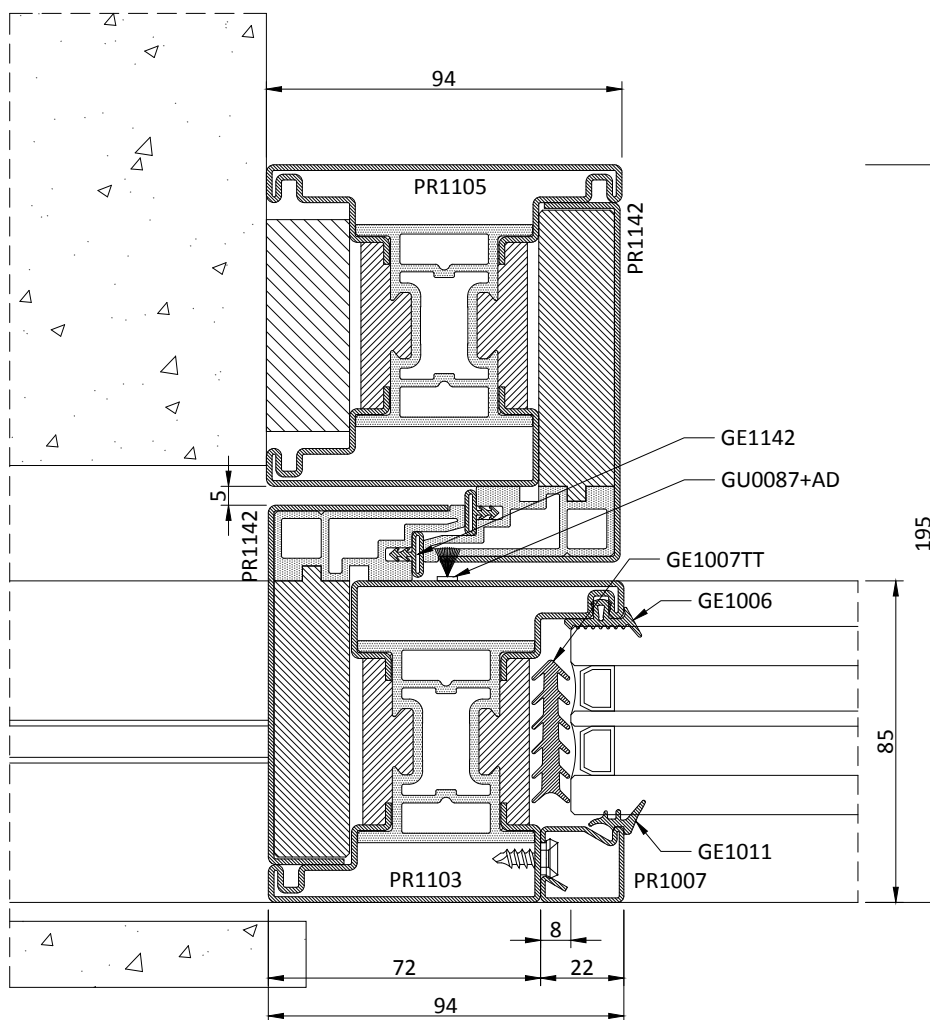

Schema | Type S1

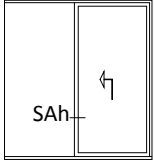

Schema | Type S2

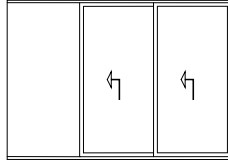

Schema | Type S3

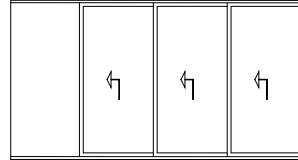

Schema | Type T1

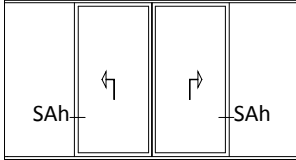

Schema | Type T2

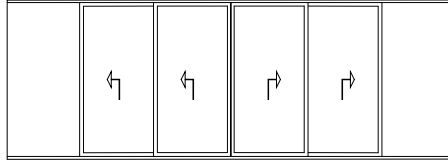

Schema | Type T3

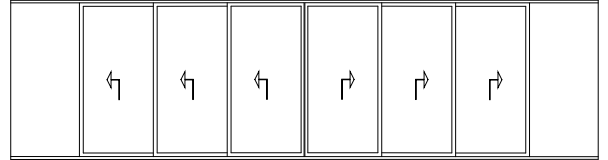

SAh.R

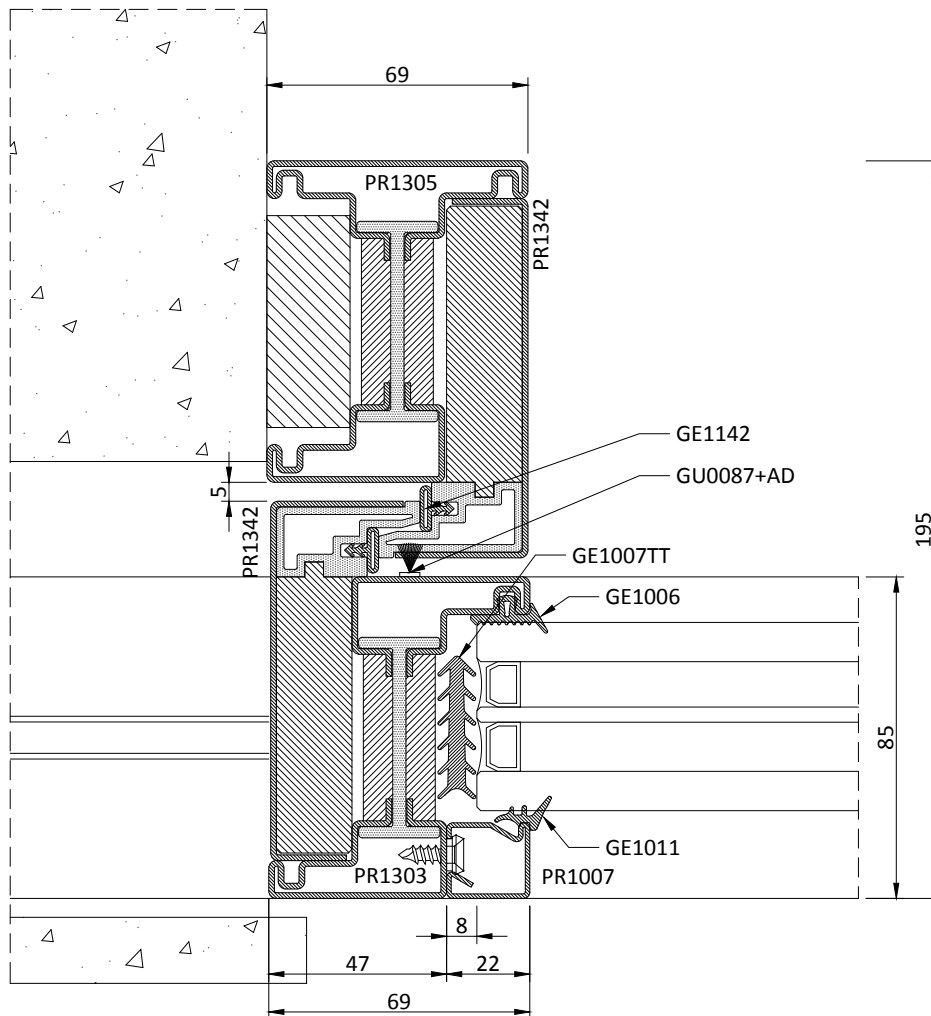

Schema | Type S1

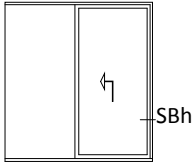

Schema | Type S2

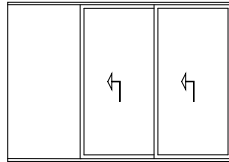

Schema | Type S3

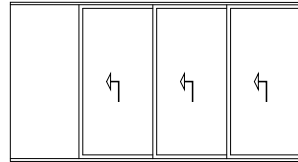

Schema | Type T1

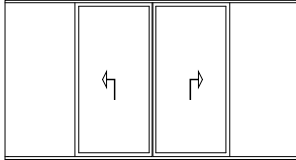

Schema | Type T2

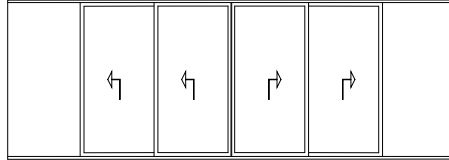

Schema | Type T3

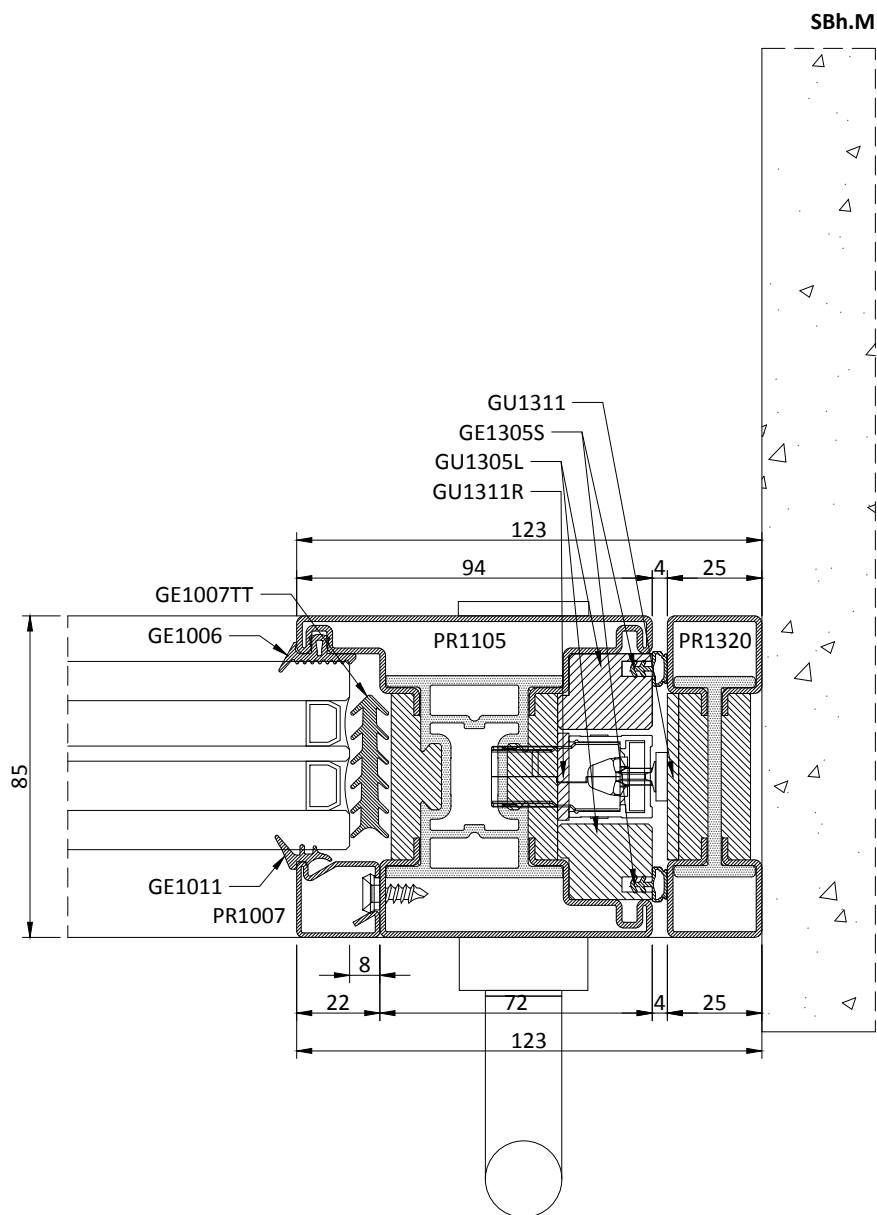
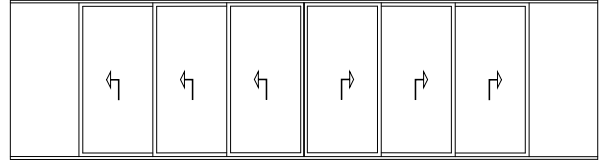

Schema | Type S1

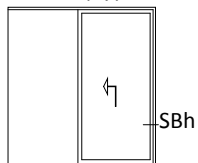

Schema | Type S2

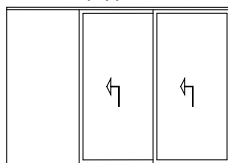

Schema | Type S3

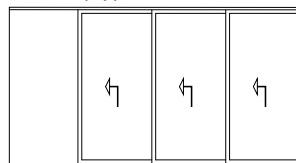

Schema | Type T1

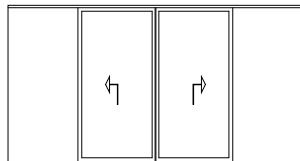

Schema | Type T2

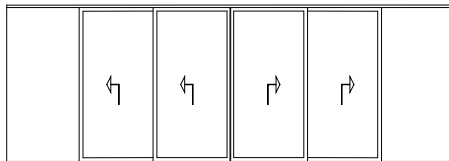

Schema | Type T3

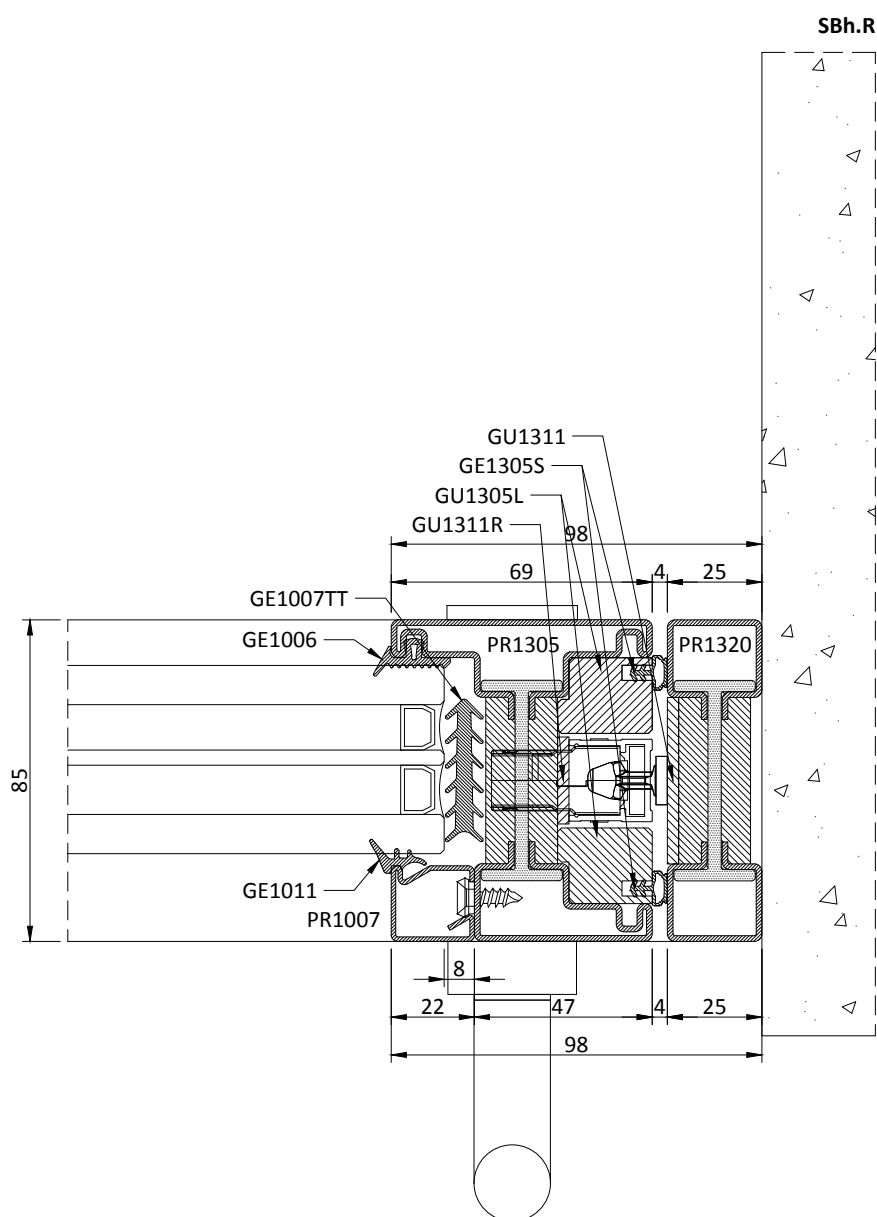
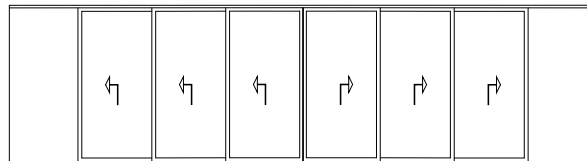

Schema | Type S1

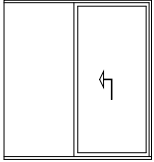

Schema | Type S2

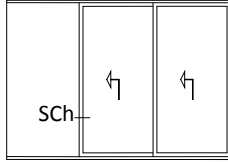

Schema | Type S3

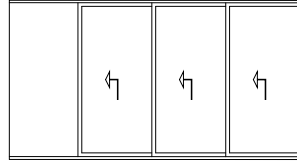

Schema | Type T1

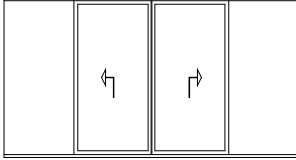

Schema | Type T2

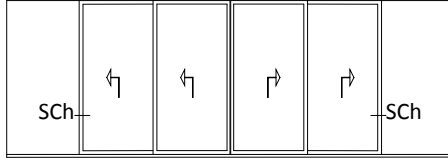

Schema | Type T3

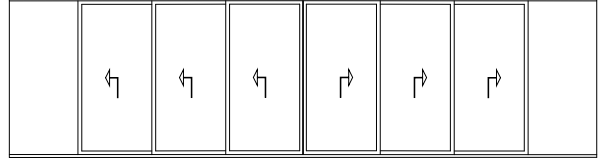

Sch.M

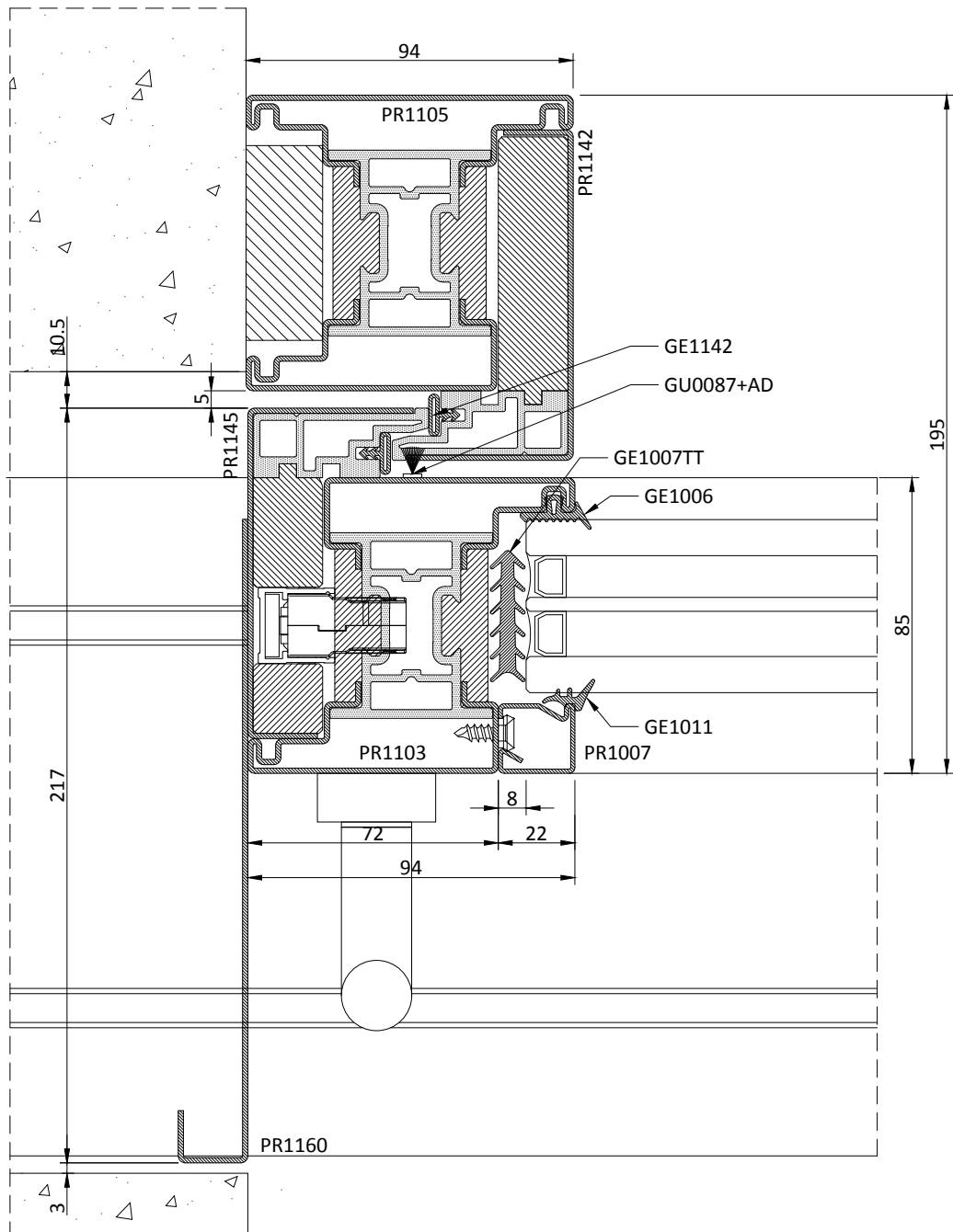

Schema | Type S1

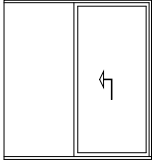

Schema | Type S2

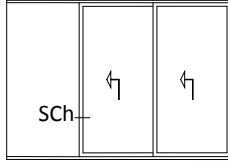

Schema | Type S3

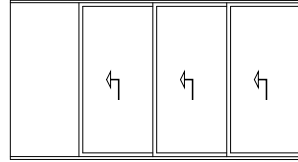

Schema | Type T1

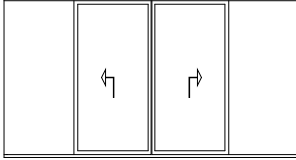

Schema | Type T2

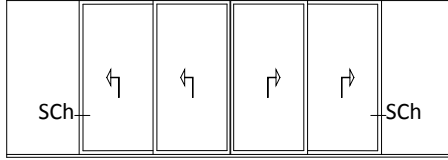

Schema | Type T3

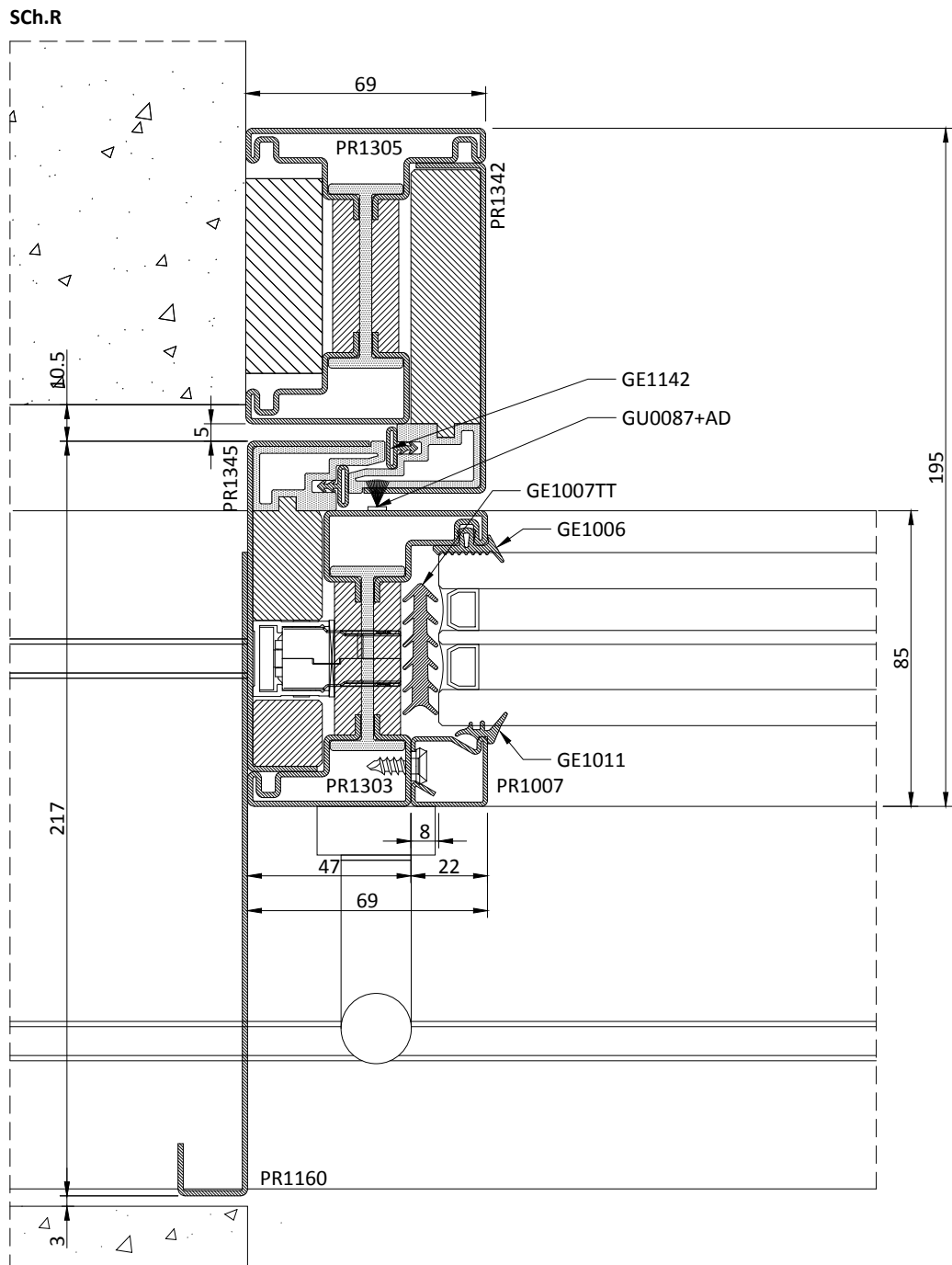
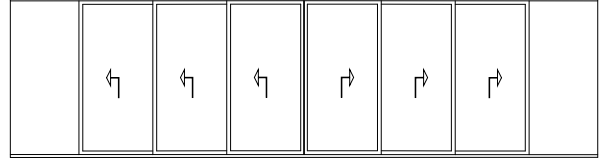

Schema | Type S1

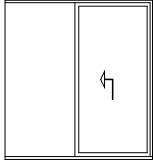

Schema | Type S2

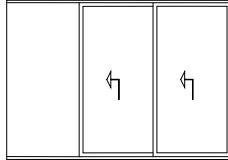

Schema | Type S3

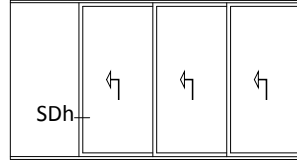

Schema | Type T1

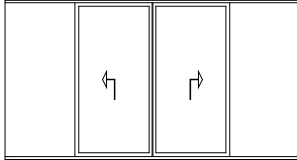

Schema | Type T2

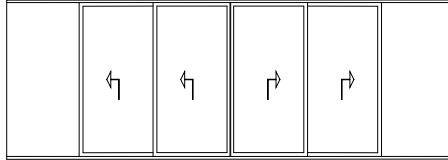

Schema | Type T3

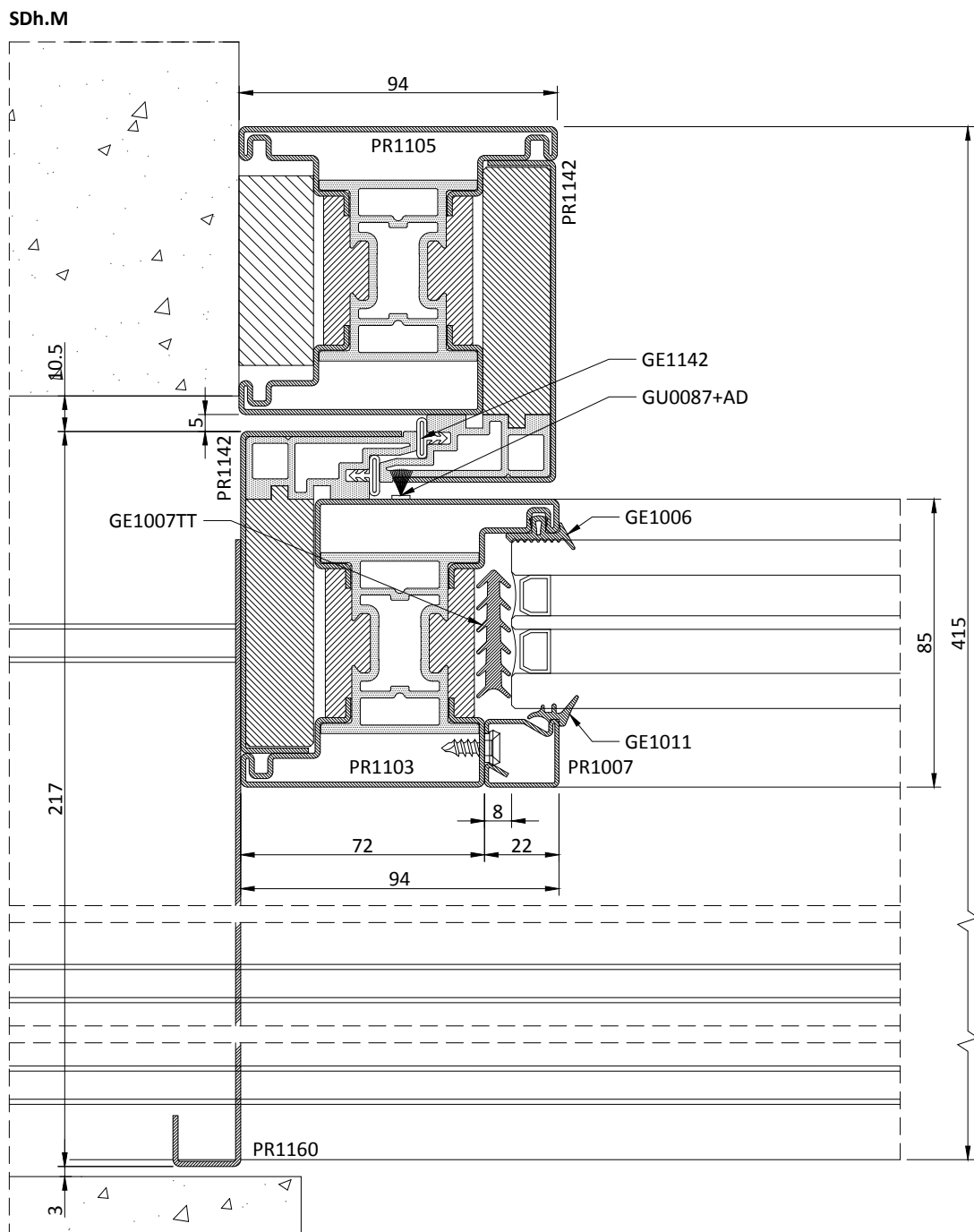
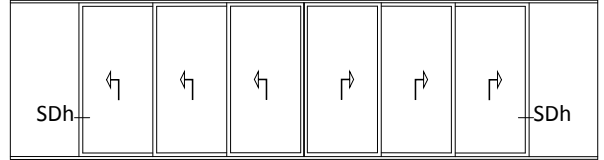

Schema | Type S1

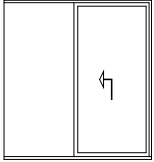

Schema | Type S2

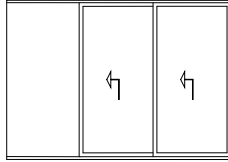

Schema | Type S3

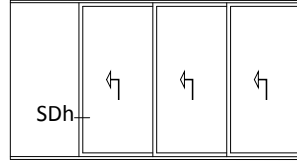

Schema | Type T1

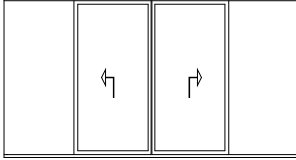

Schema | Type T2

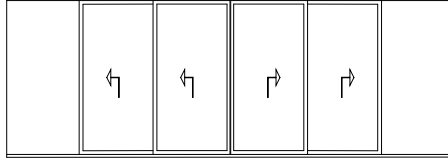

Schema | Type T3

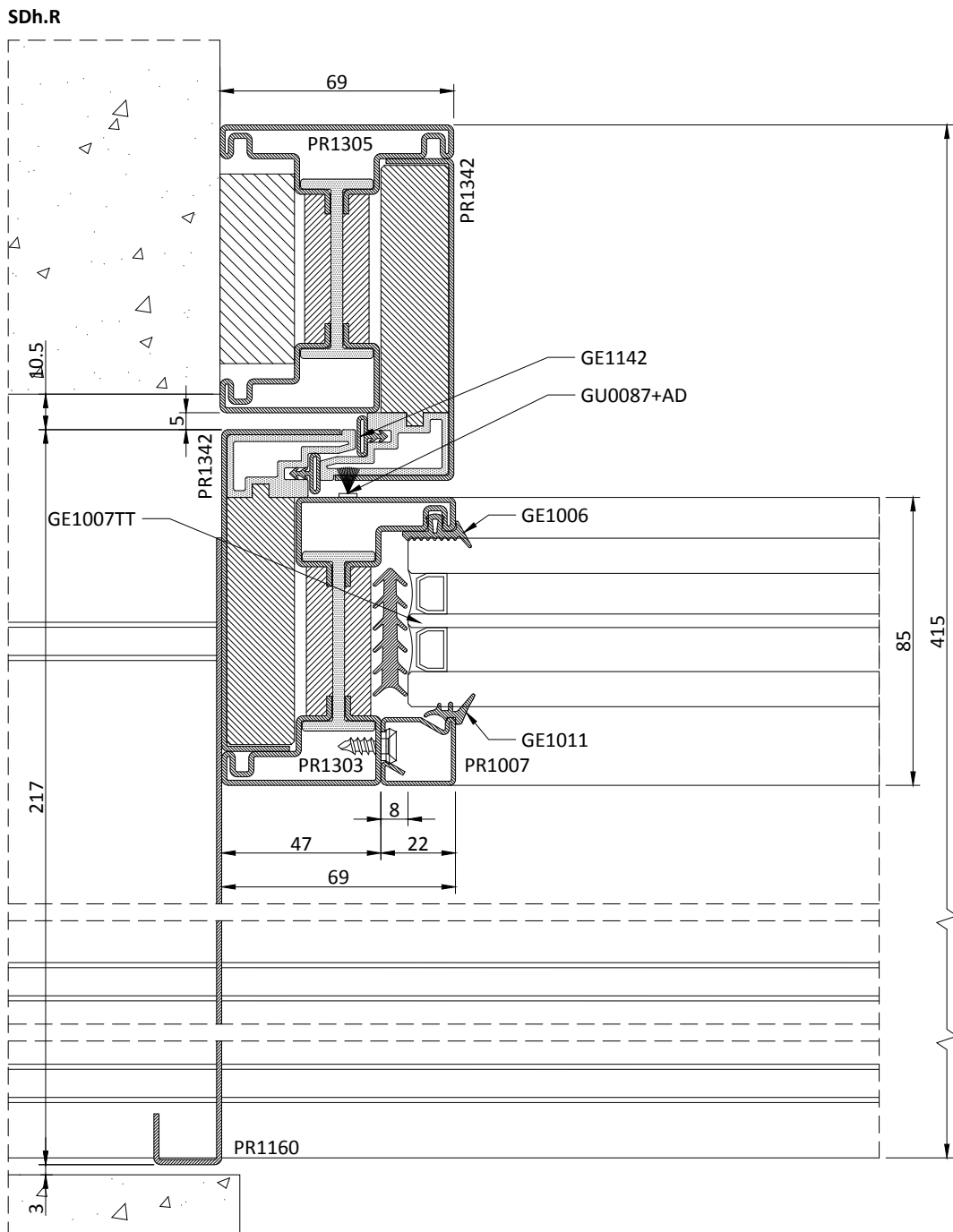
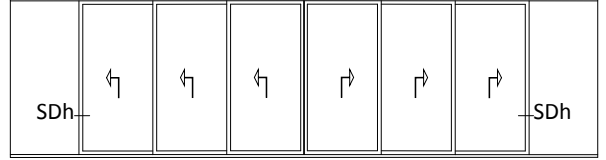



Schema | Type S1

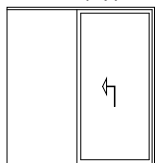

Schema | Type S2

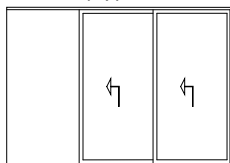

Schema | Type S3

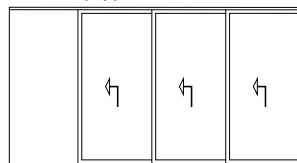

Schema | Type T1

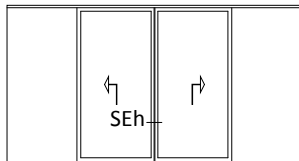

Schema | Type T2

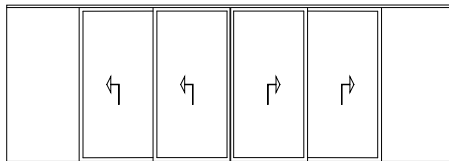

Schema | Type T3

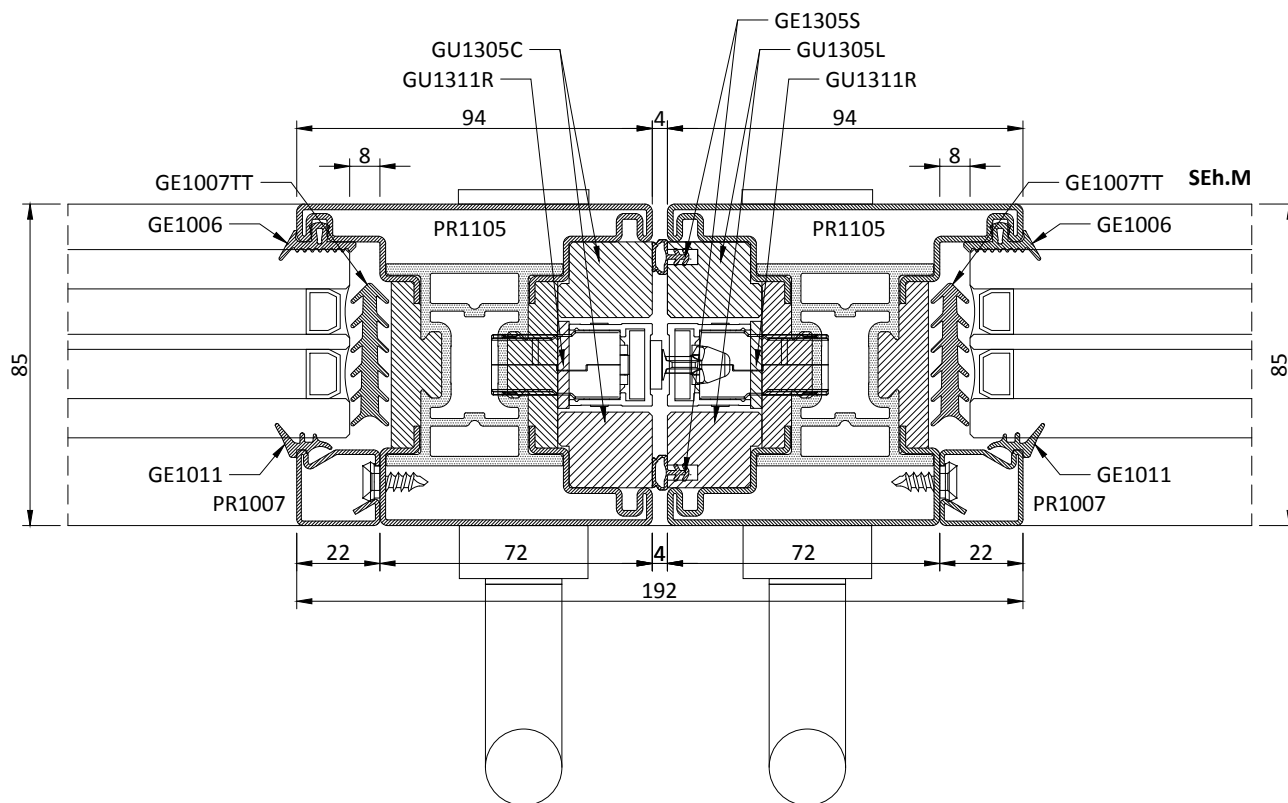
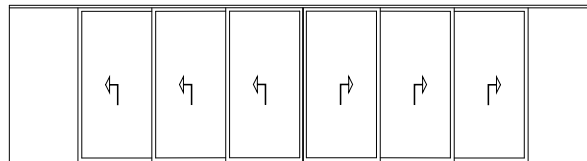

Schema | Type S1

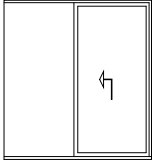

Schema | Type S2

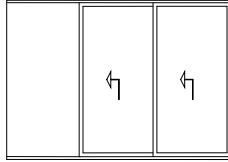

Schema | Type S3

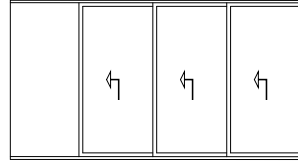

Schema | Type T1

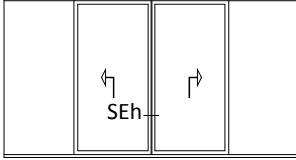

Schema | Type T2

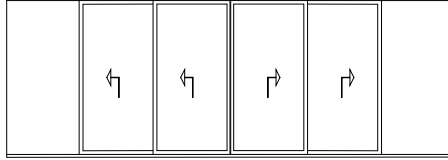

Schema | Type T3

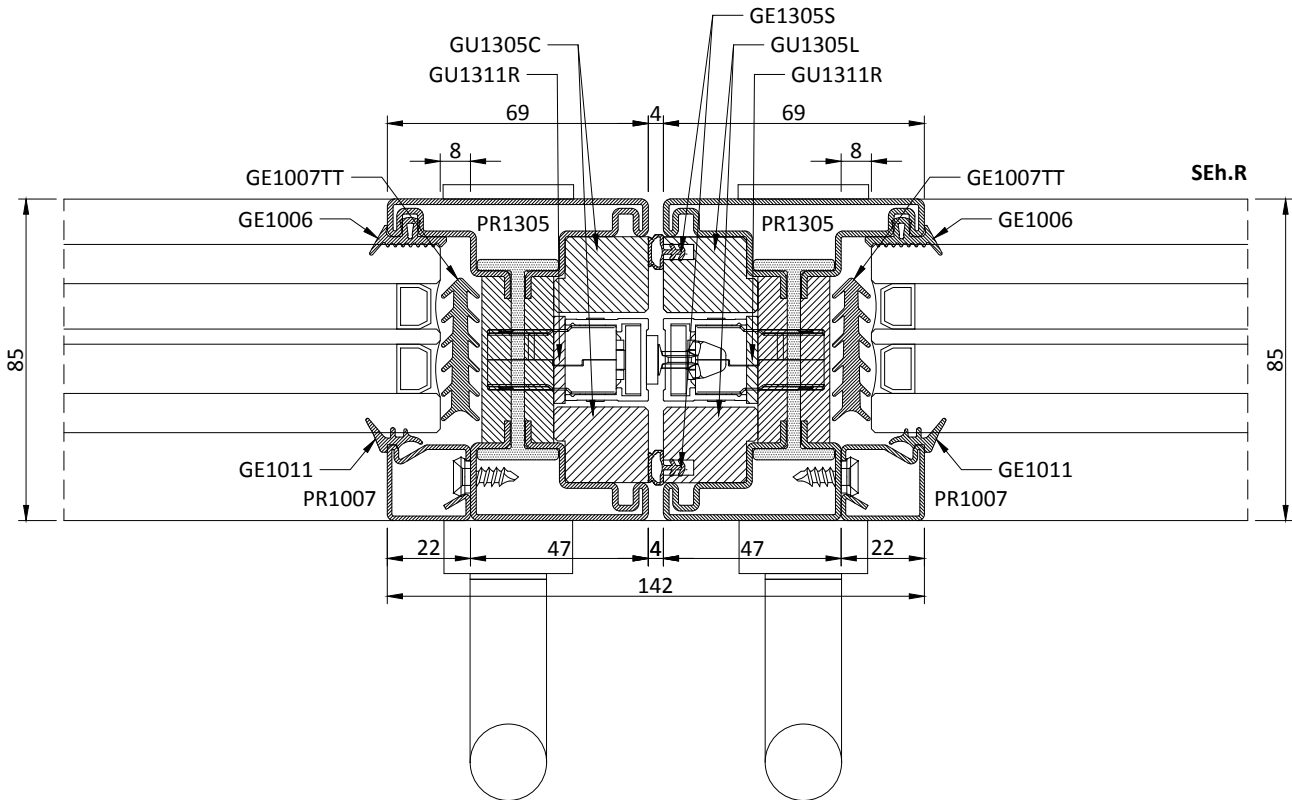
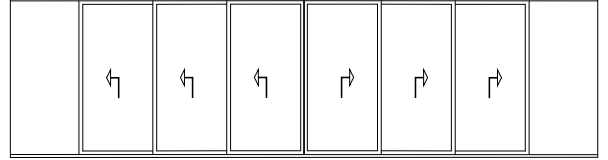

Schema | Type S1

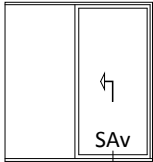

Schema | Type S2

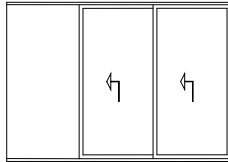

Schema | Type S3

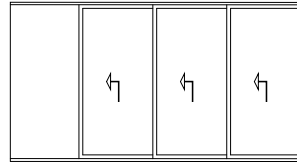

Schema | Type T1

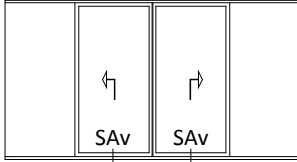

Schema | Type T2

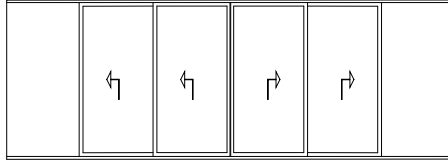

Schema | Type T3

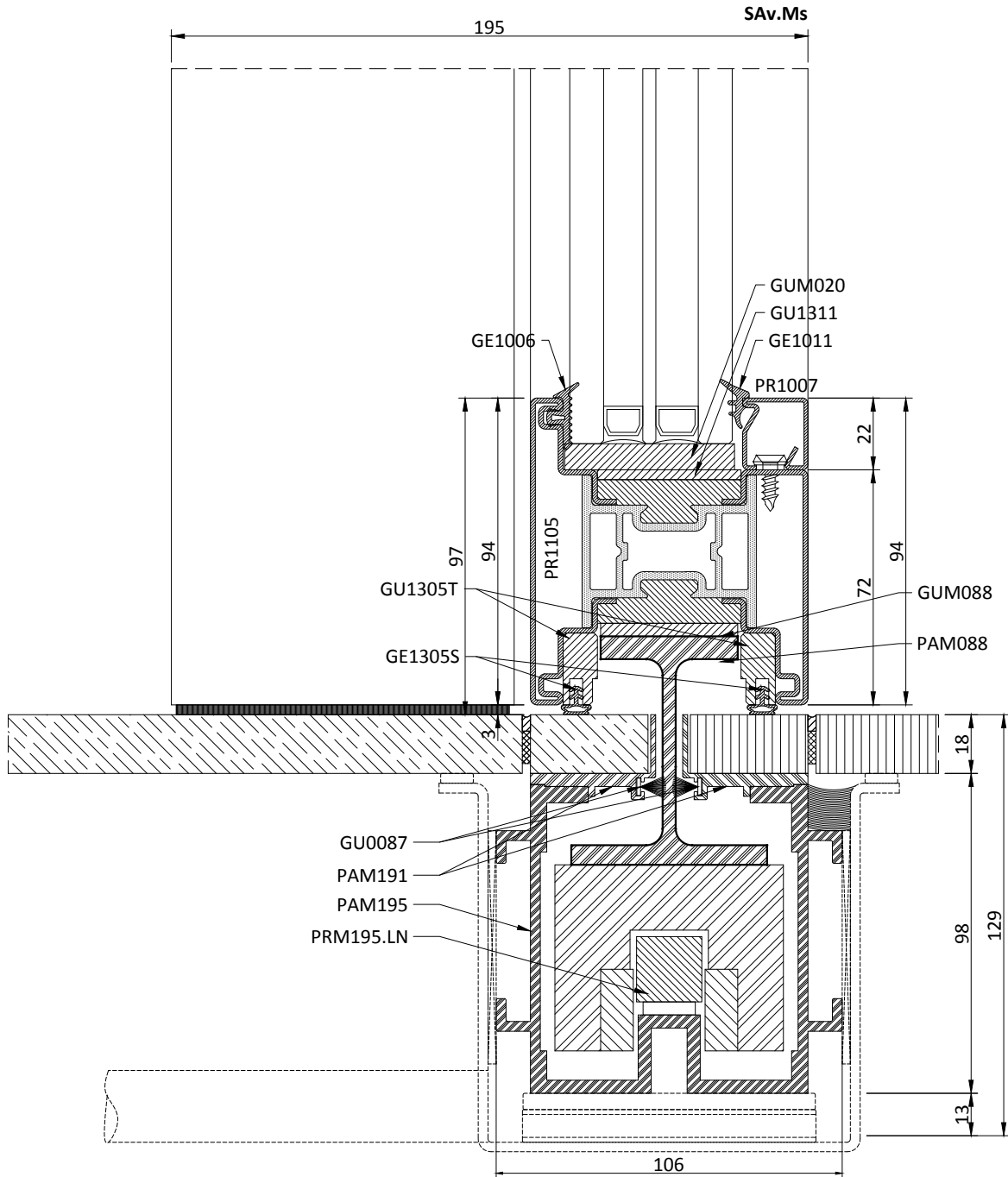
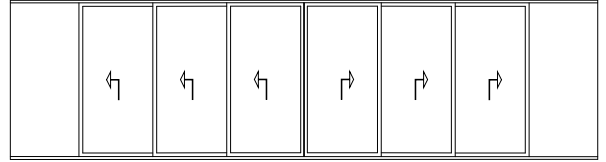

Schema | Type S1

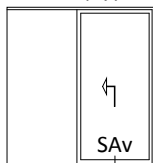

Schema | Type S2

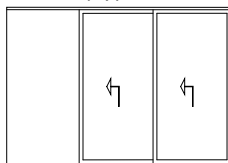

Schema | Type S3

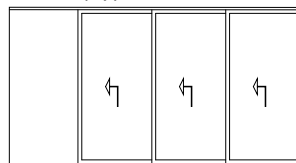

Schema | Type T1

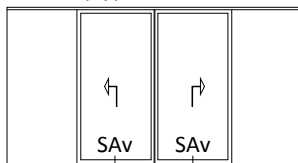

Schema | Type T2

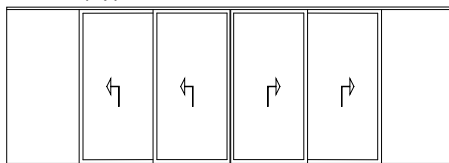

Schema | Type T3

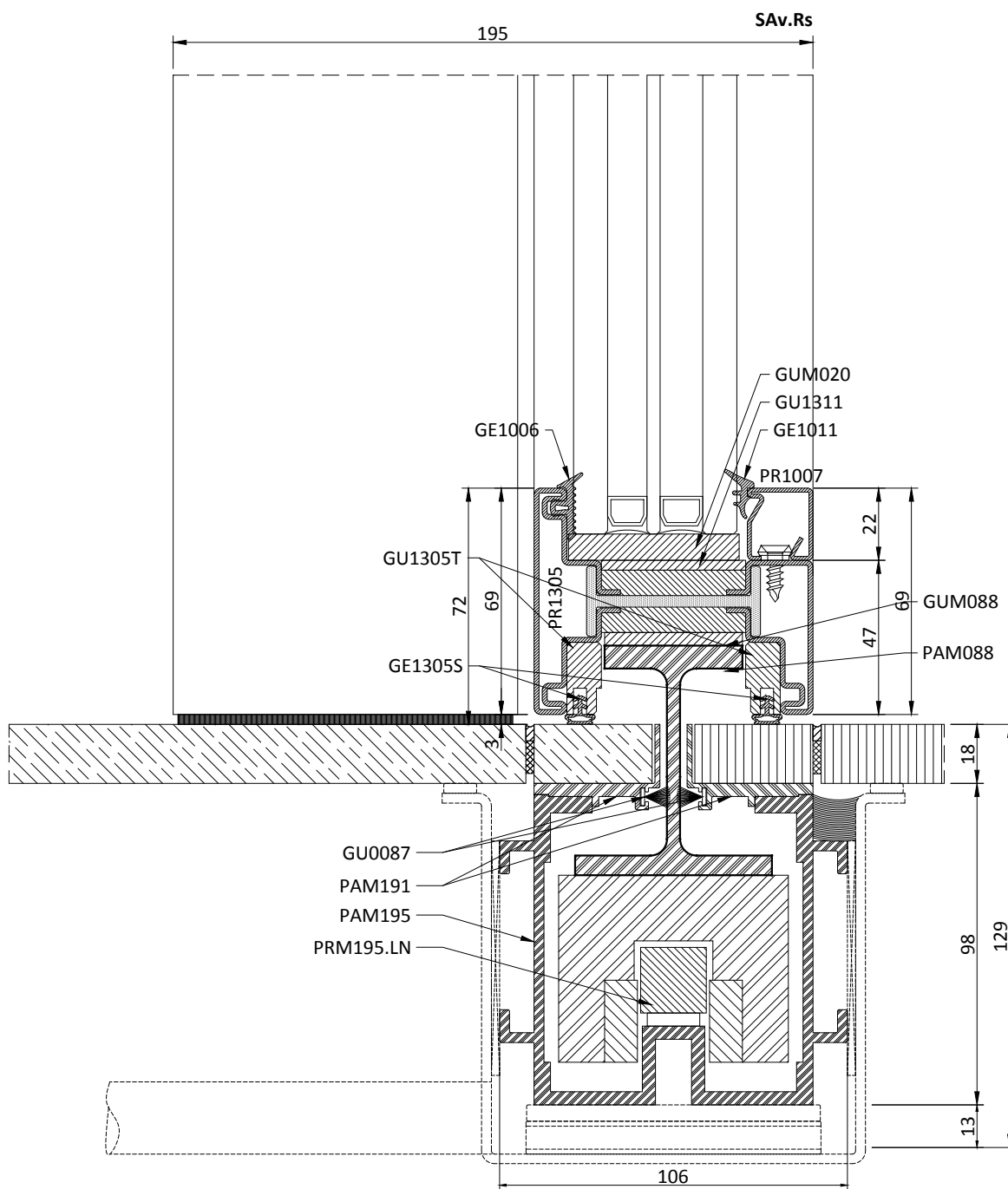
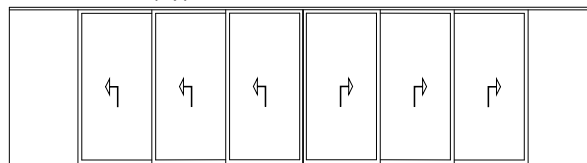

Schema | Type S1

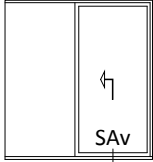

Schema | Type S2

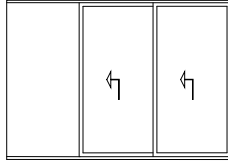

Schema | Type S3

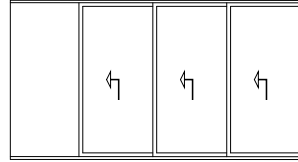

Schema | Type T1

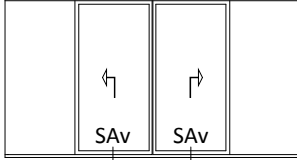

Schema | Type T2

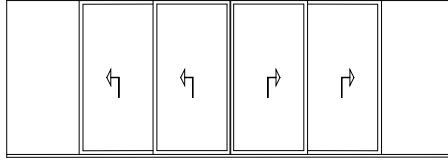

Schema | Type T3

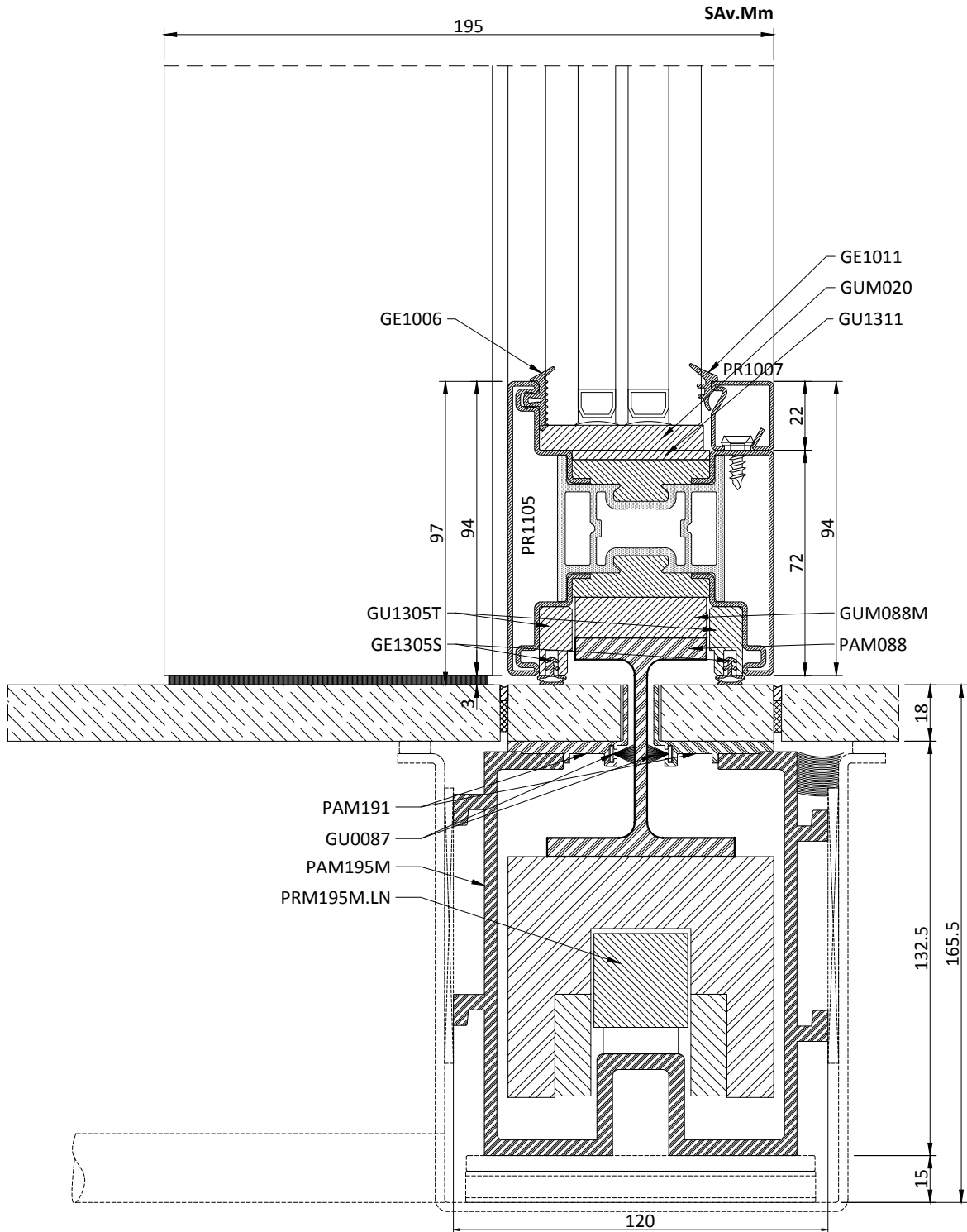
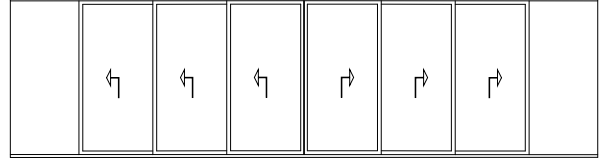

Schema | Type S1

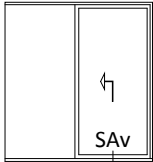

Schema | Type S2

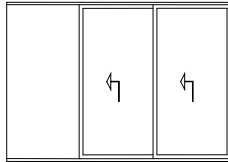

Schema | Type S3

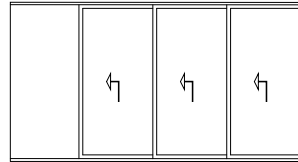

Schema | Type T1

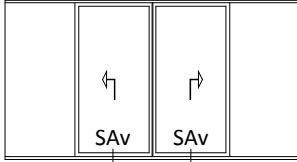

Schema | Type T2

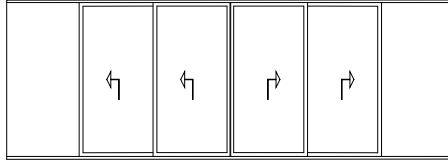

Schema | Type T3

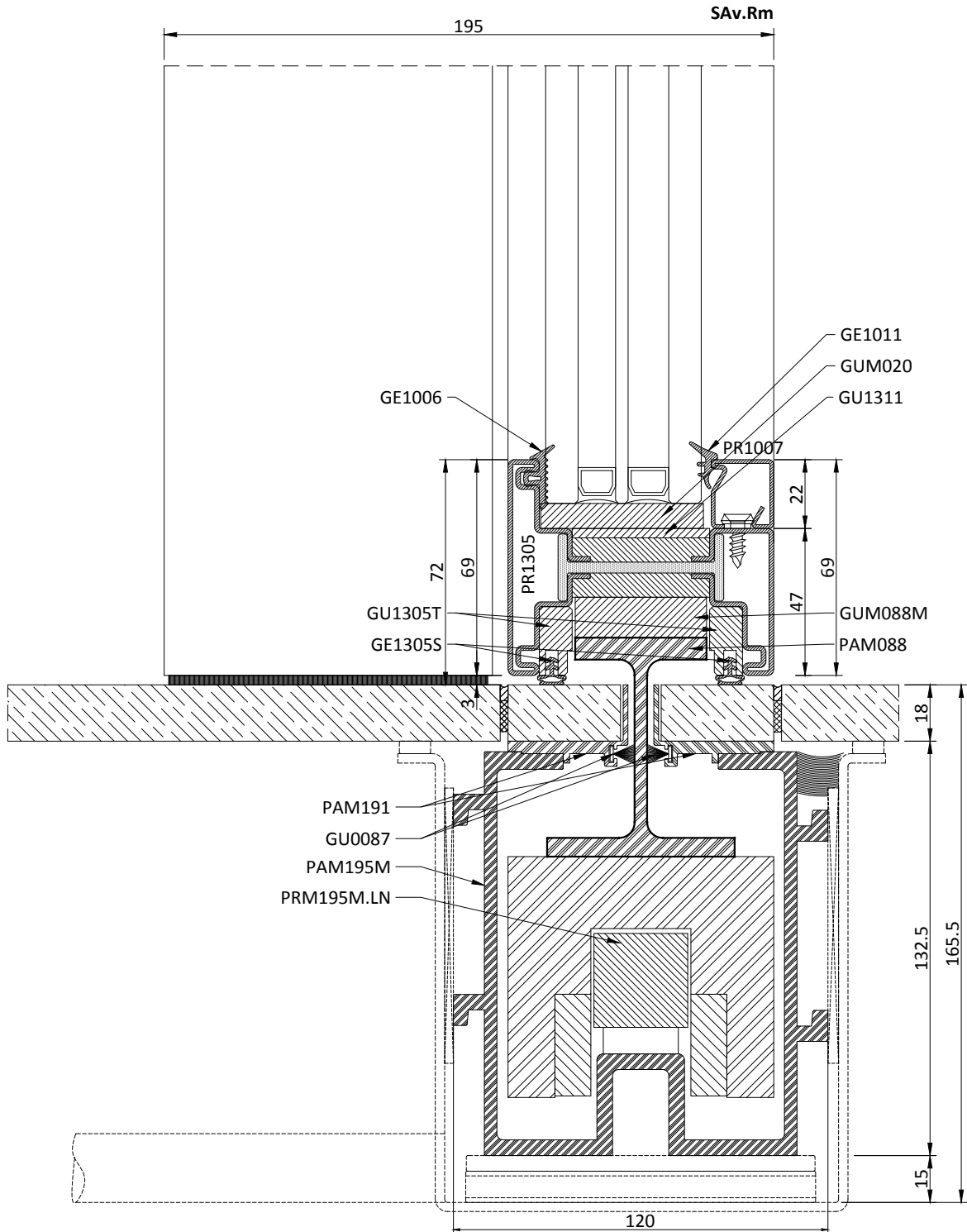
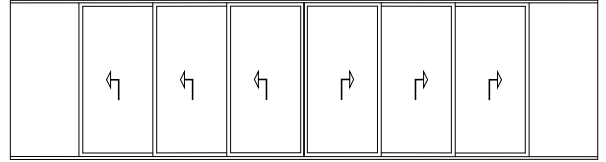

Schema | Type S1

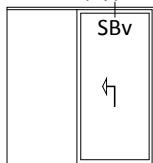

Schema | Type S2

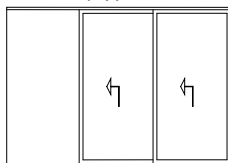

Schema | Type S3

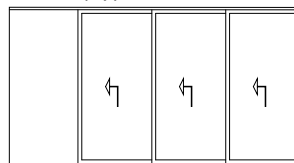

Schema | Type T1

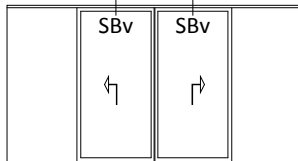

Schema | Type T2

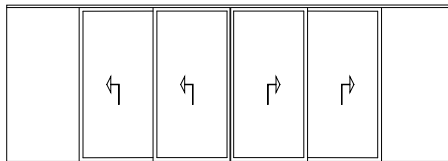

Schema | Type T3

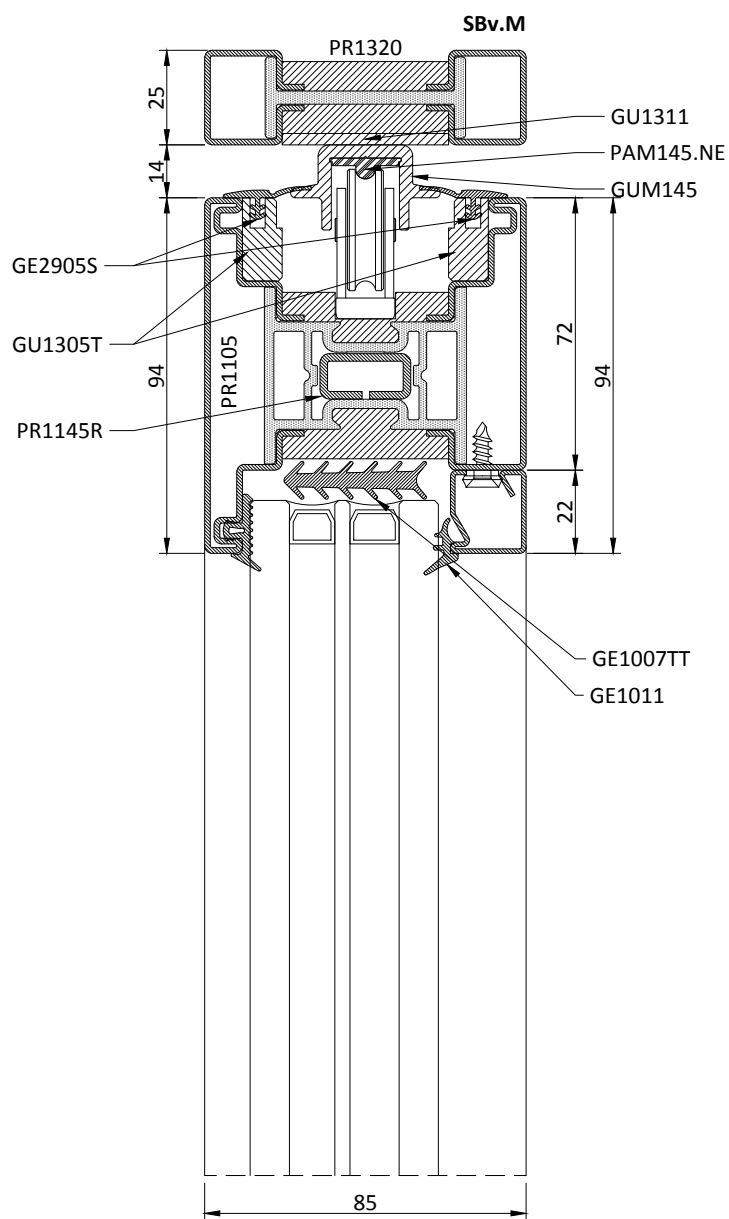
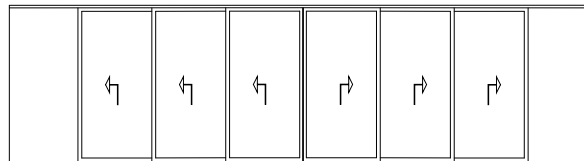

Schema | Type S1

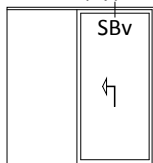

Schema | Type S2

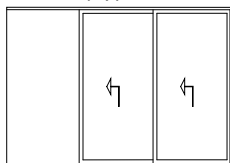

Schema | Type S3

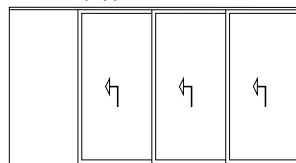

Schema | Type T1

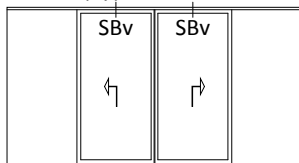

Schema | Type T2

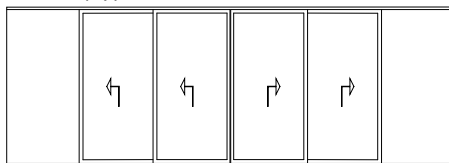

Schema | Type T3

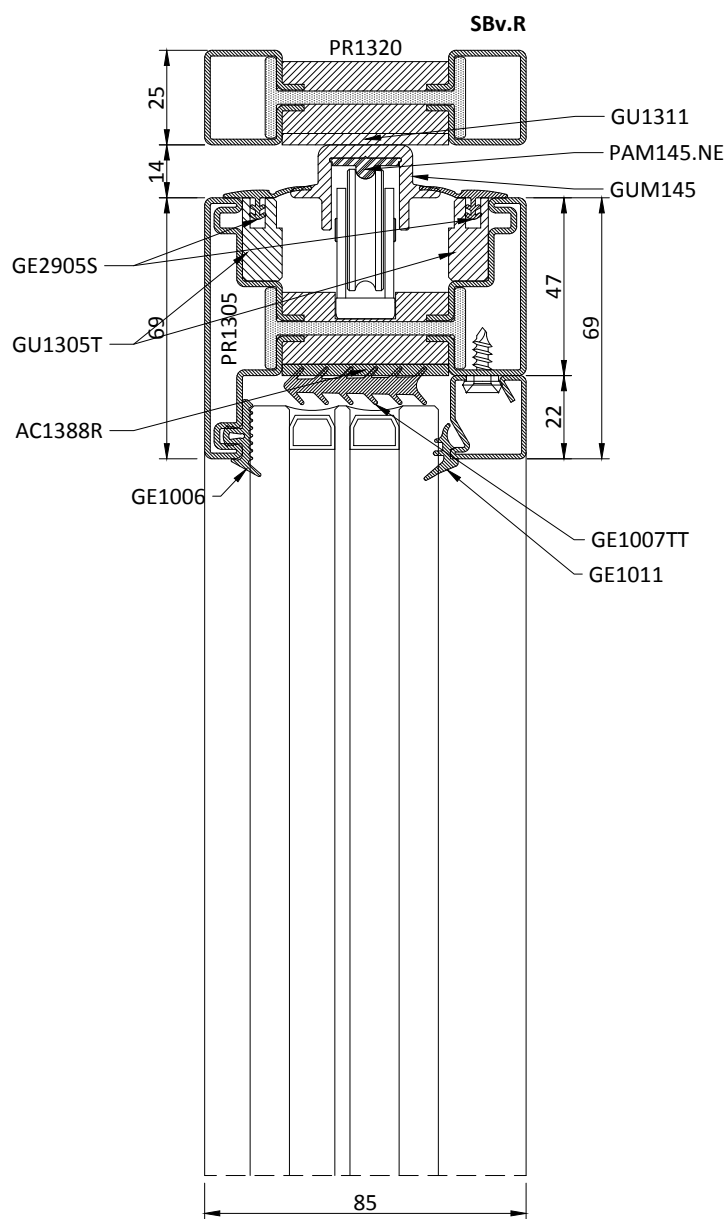
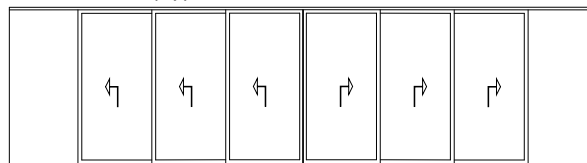



Schema | Type S1

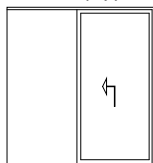

Schema | Type S2

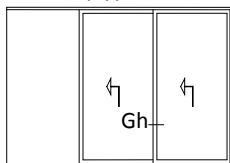

Schema | Type S3

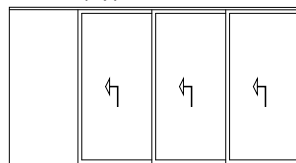

Schema | Type T1

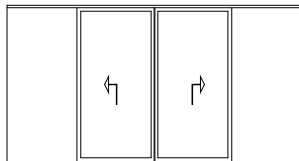

Schema | Type T2

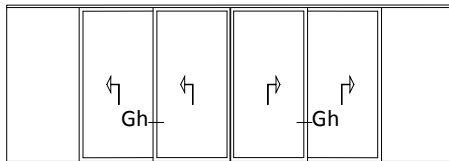

Schema | Type T3

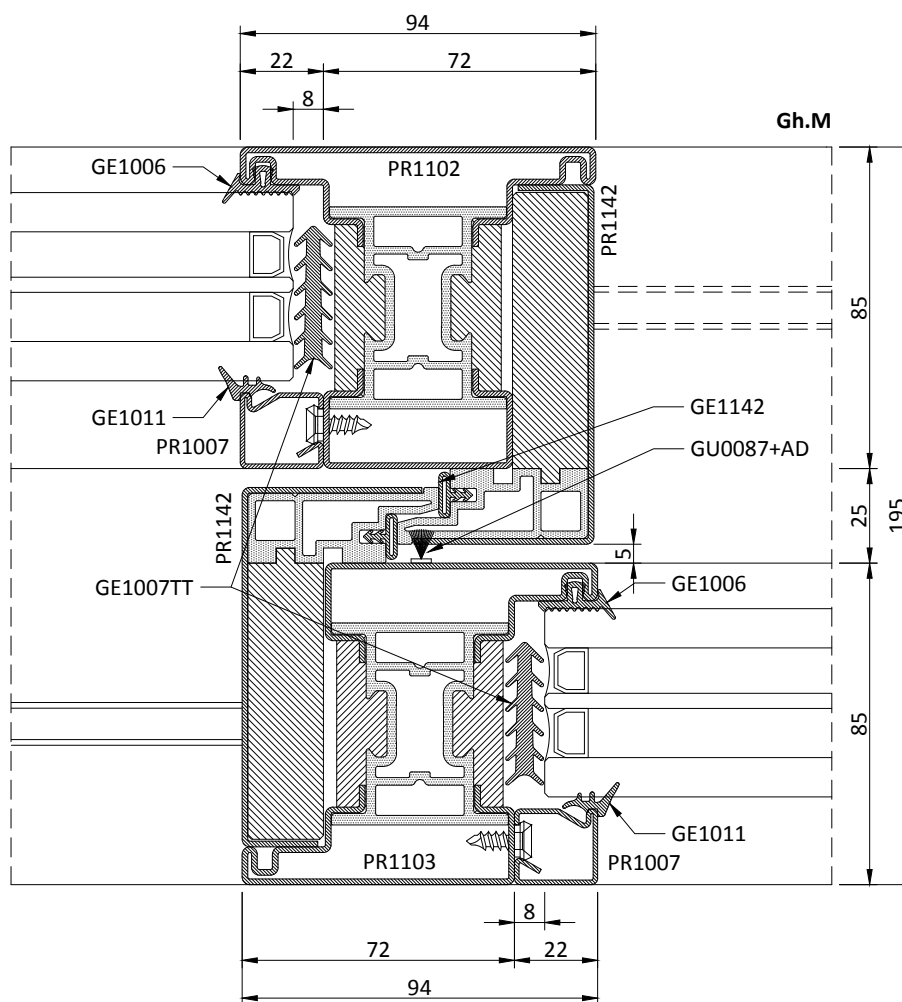
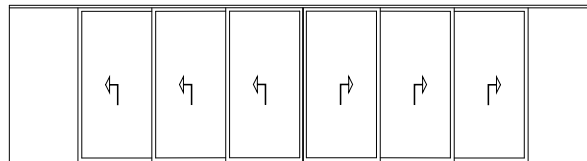

Schema | Type S1

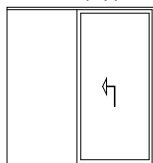

Schema | Type S2

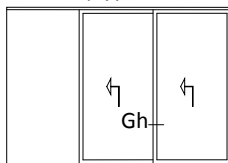

Schema | Type S3

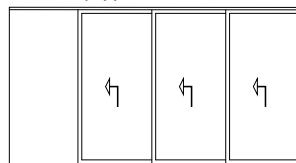

Schema | Type T1

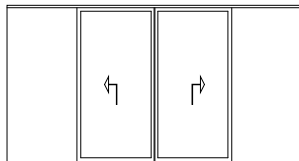

Schema | Type T2

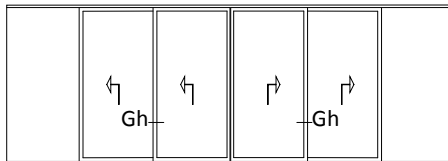

Schema | Type T3

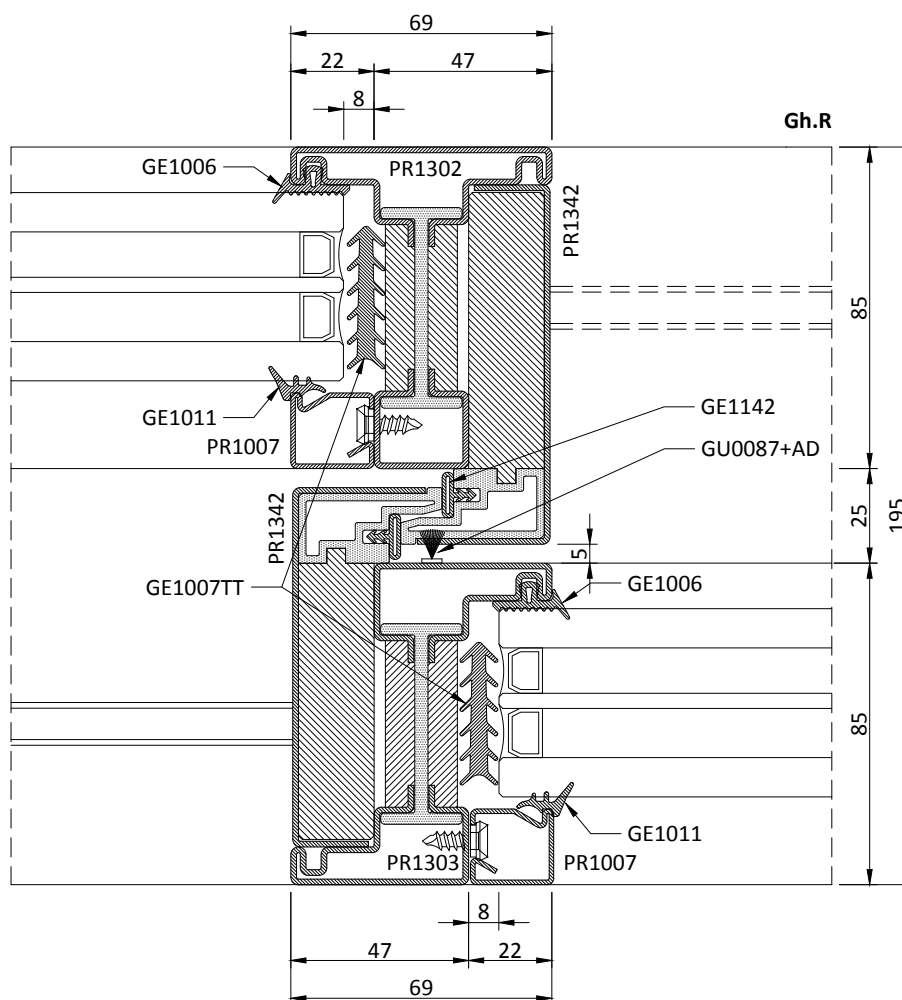
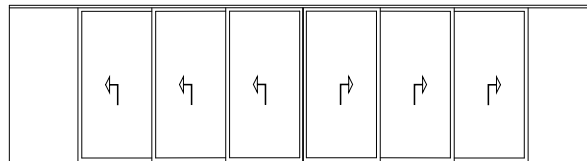

Schema | Type S1

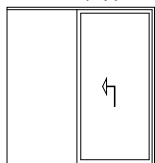

Schema | Type S2

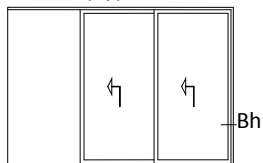

Schema | Type S3

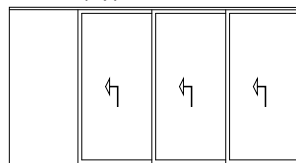

Schema | Type T1

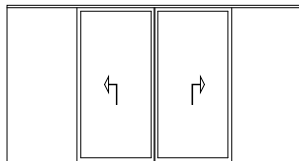

Schema | Type T2

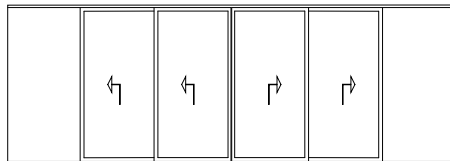

Schema | Type T3

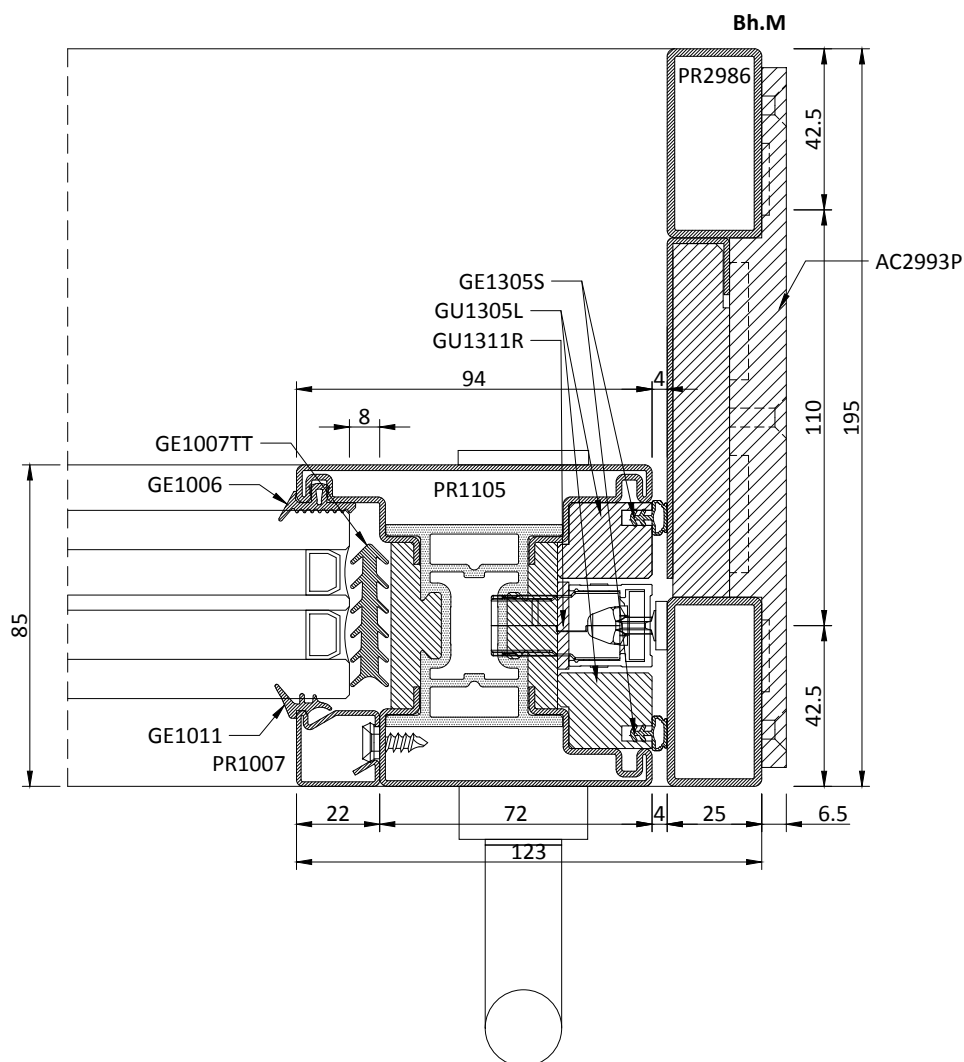
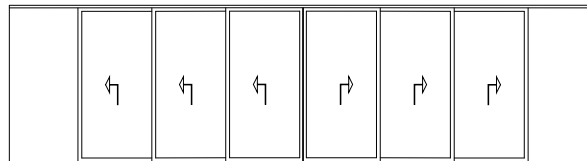

Schema | Type S1

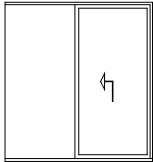

Schema | Type S2

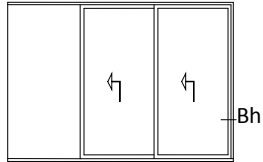

Schema | Type S3

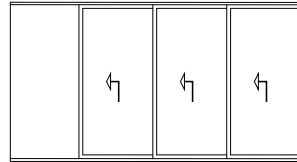

Schema | Type T1

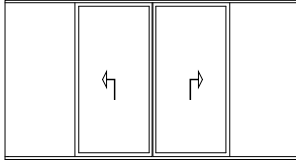

Schema | Type T2

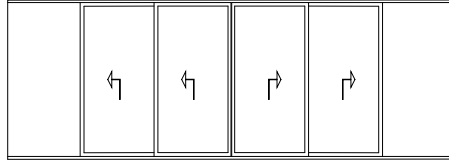

Schema | Type T3

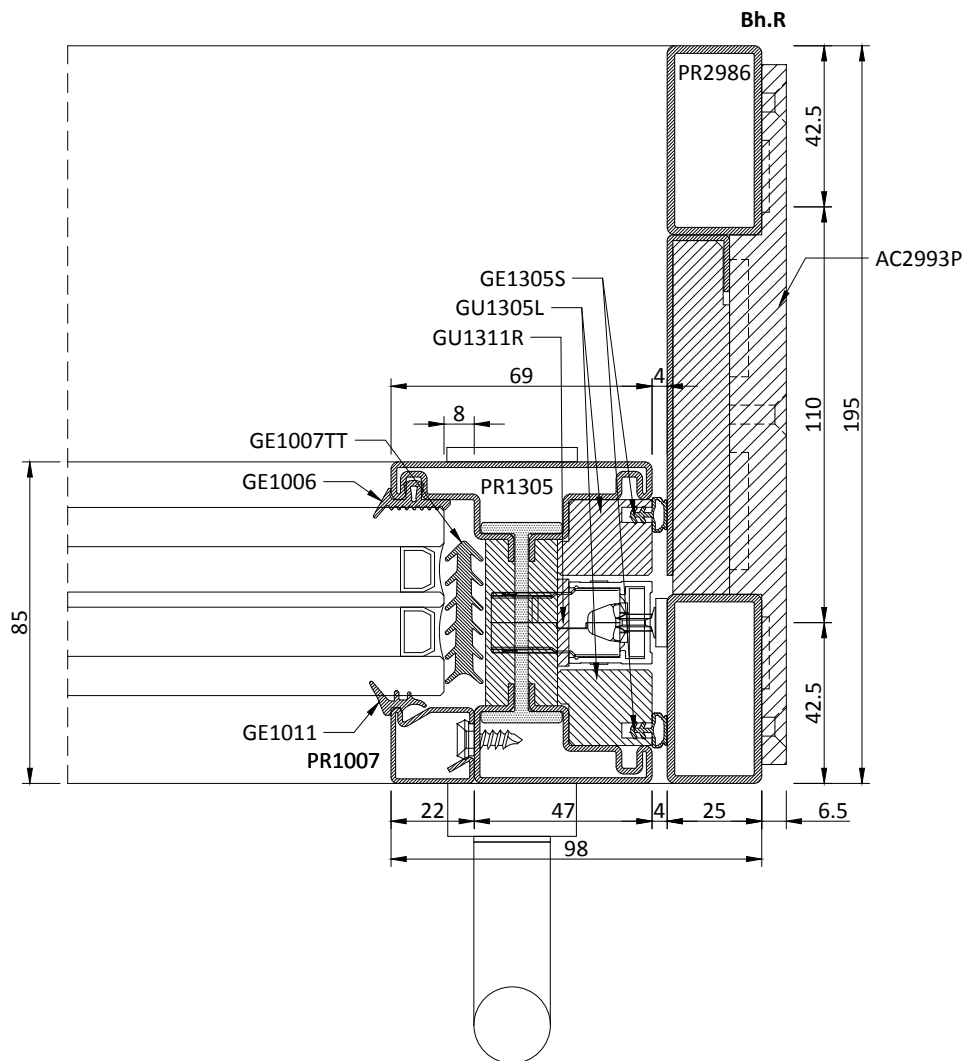
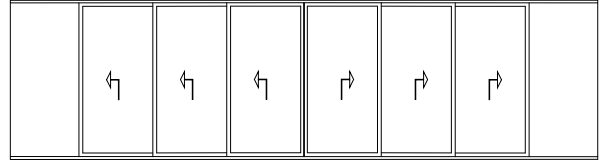

Schema | Type S1

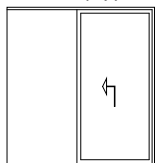

Schema | Type S2

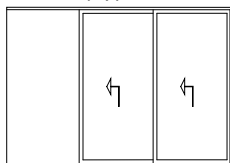

Schema | Type S3

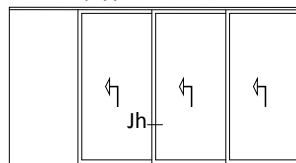

Schema | Type T1

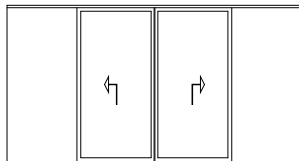

Schema | Type T2

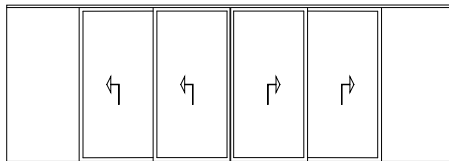

Schema | Type T3

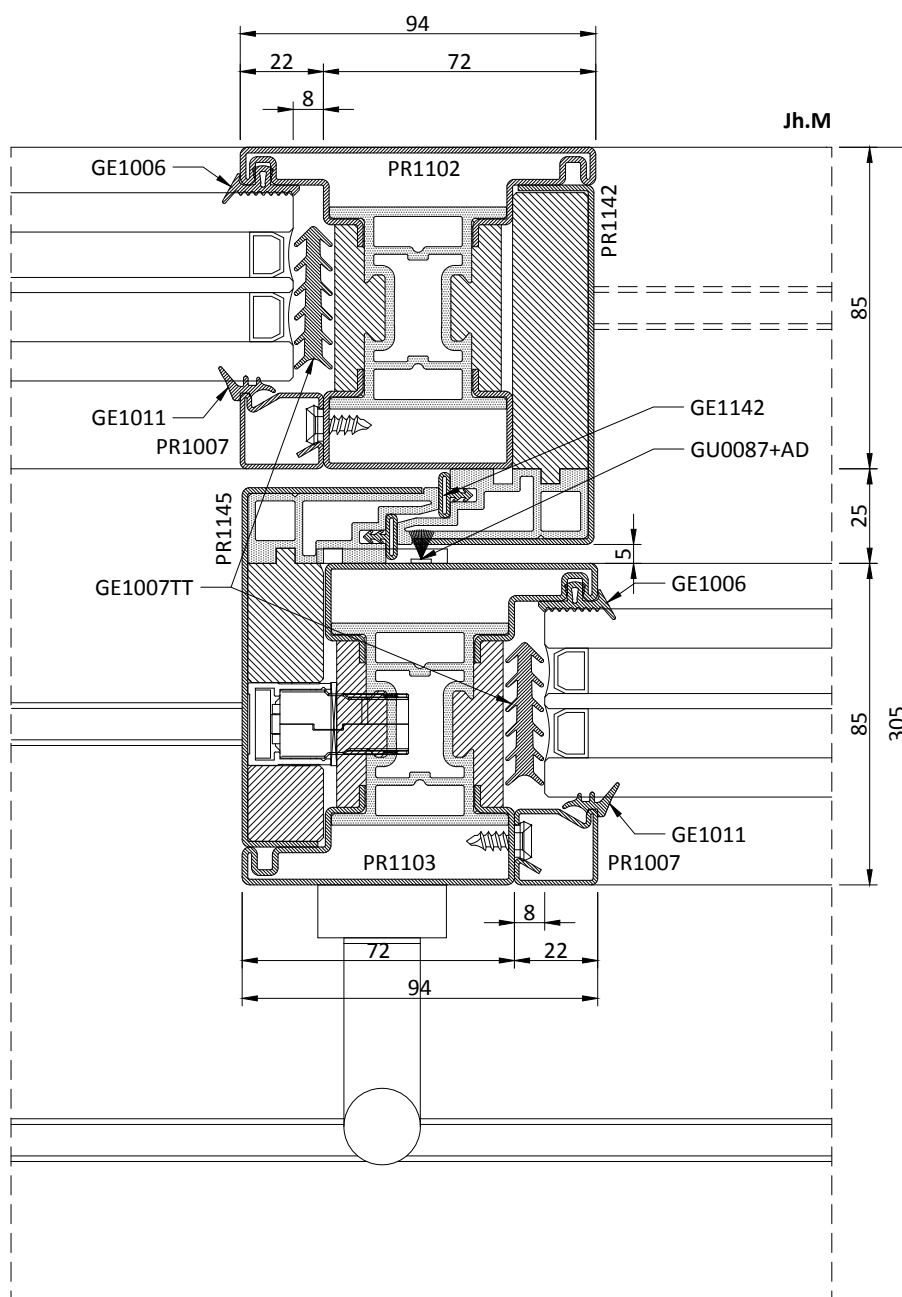
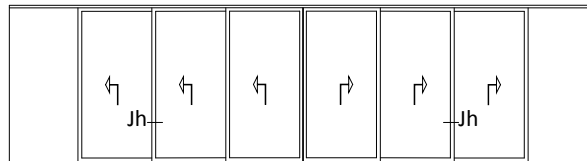

Schema | Type S1

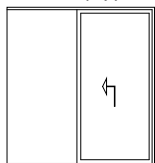

Schema | Type S2

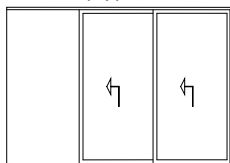

Schema | Type S3

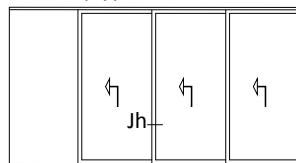

Schema | Type T1

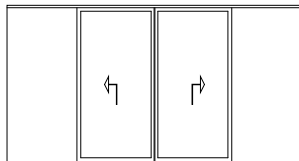

Schema | Type T2

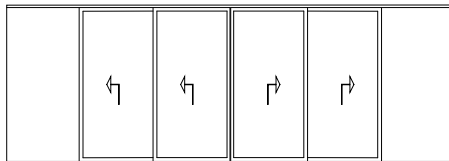

Schema | Type T3

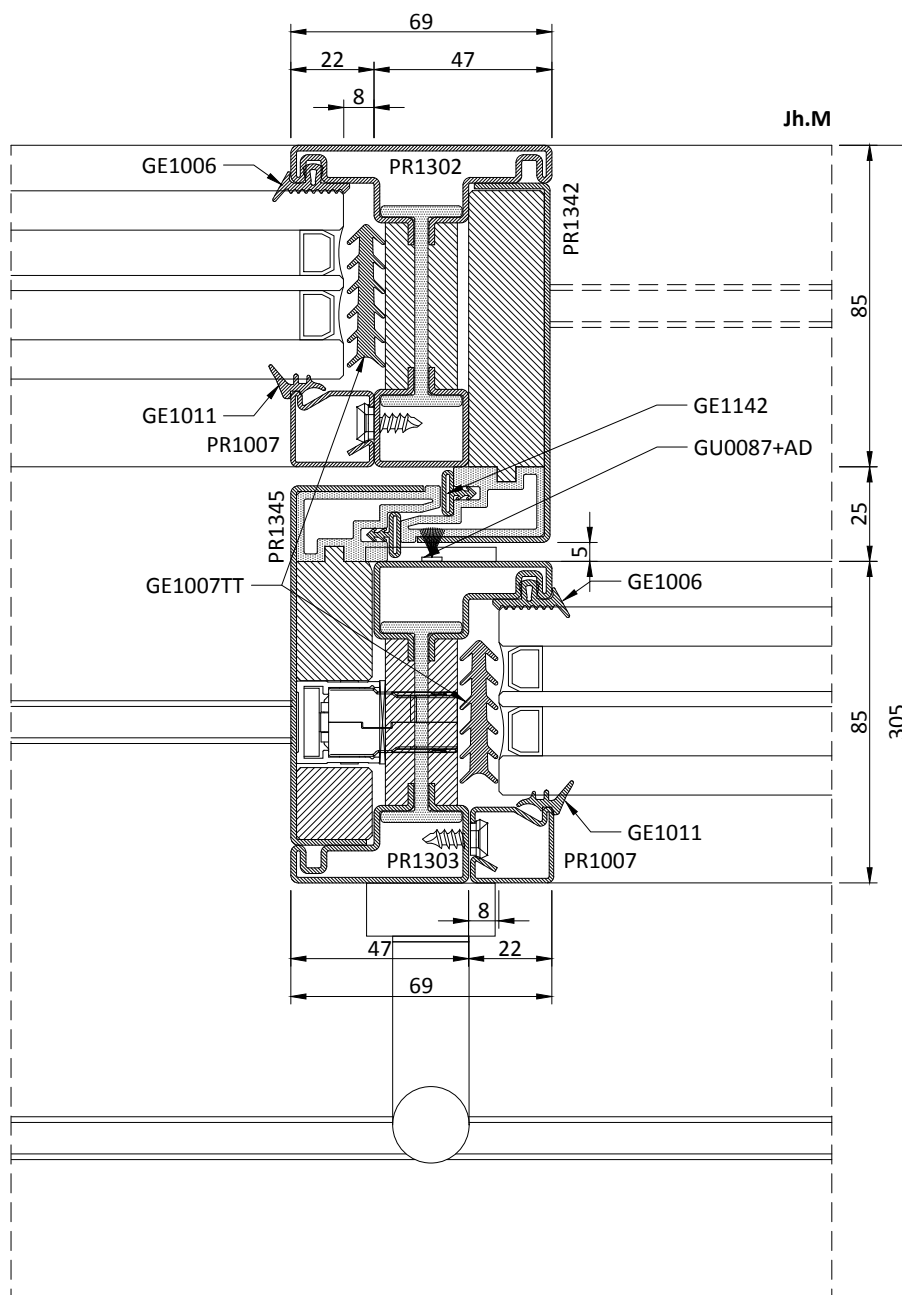
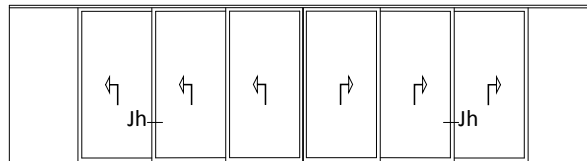

Schema | Type S1

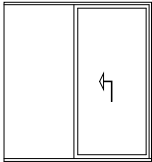

Schema | Type S2

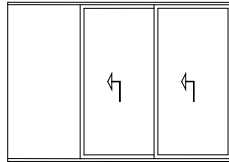

Schema | Type S3

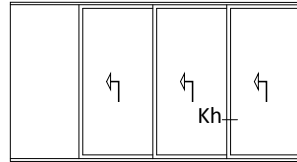

Schema | Type T1

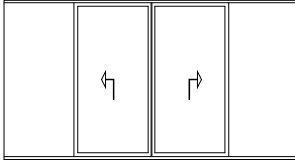

Schema | Type T2

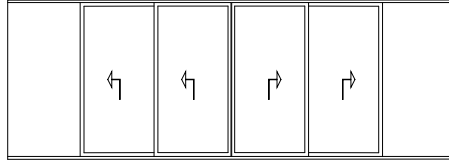

Schema | Type T3

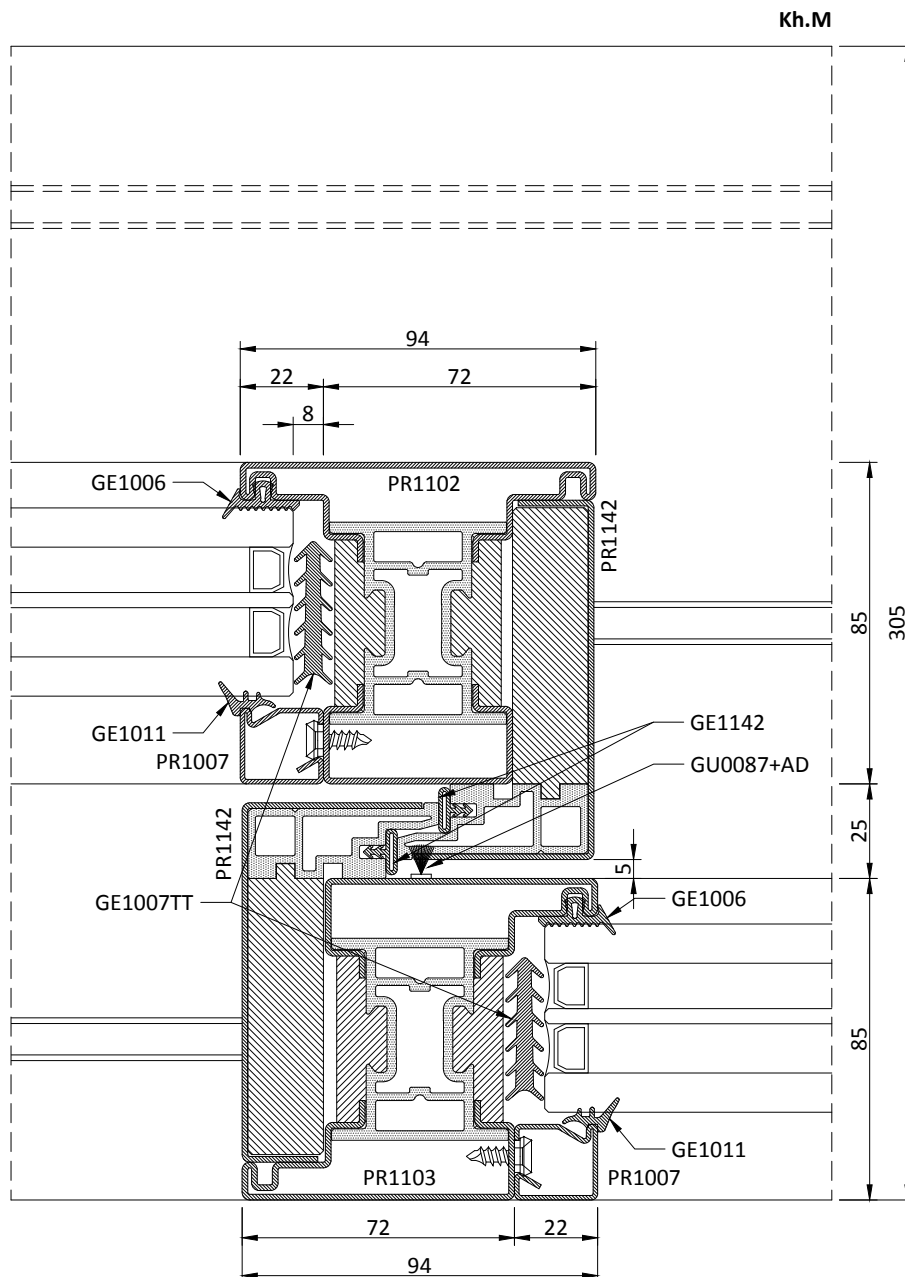
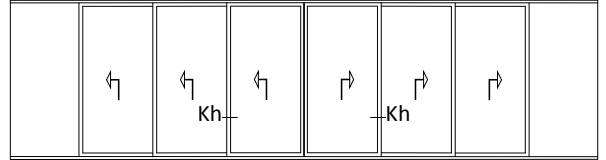

Schema | Type S1

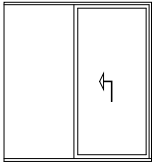

Schema | Type S2

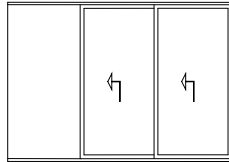

Schema | Type S3

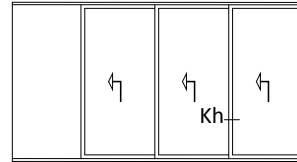

Schema | Type T1

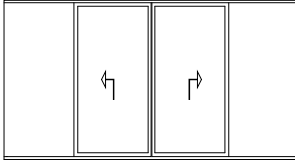

Schema | Type T2

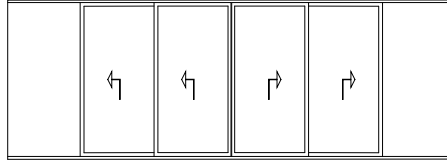

Schema | Type T3

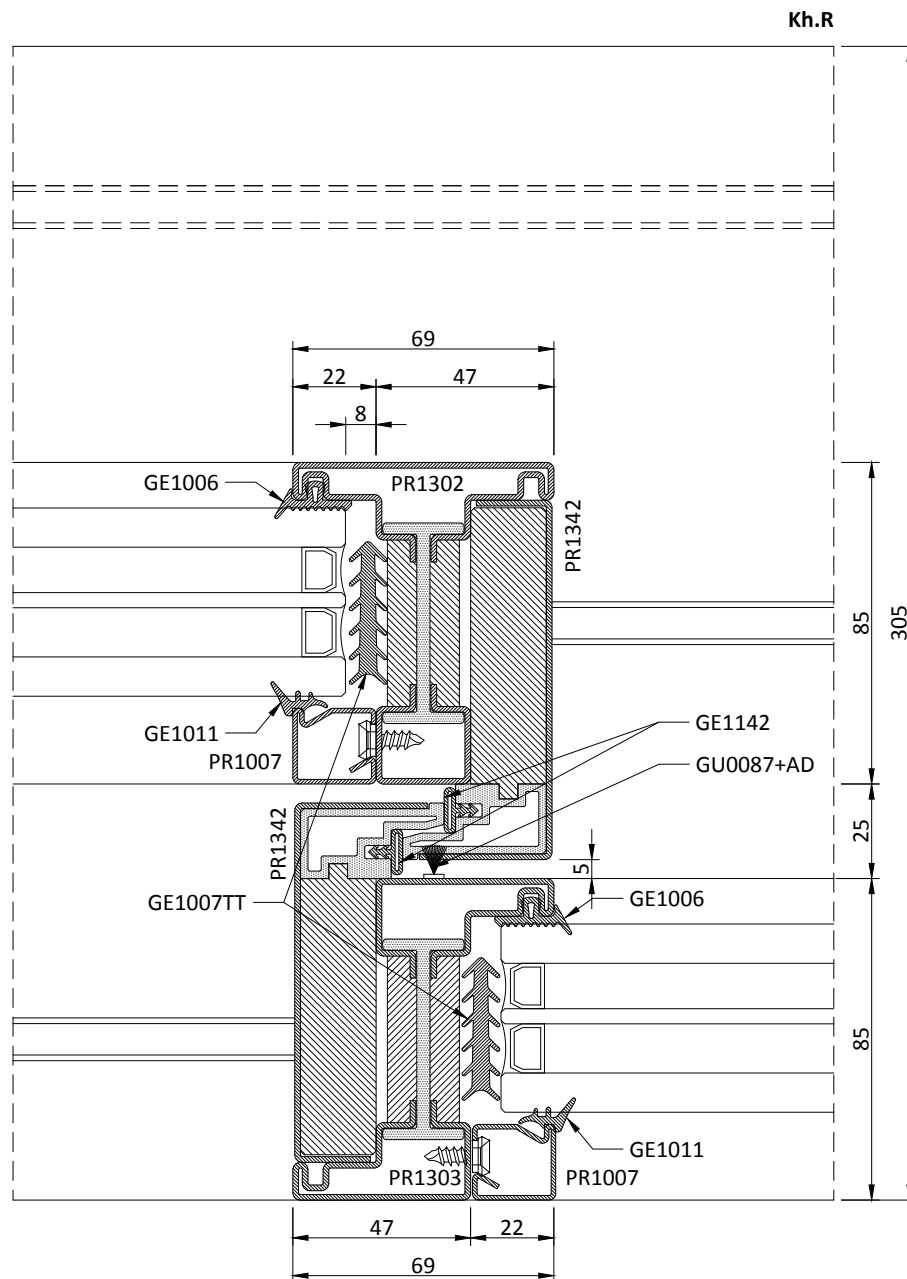
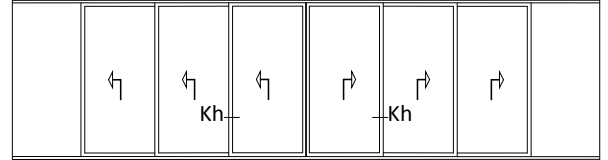



Schema | Type S1

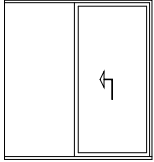

Schema | Type S2

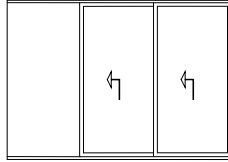

Schema | Type S3

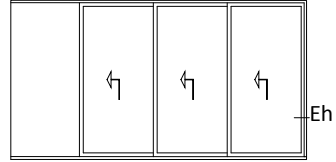

Schema | Type T1

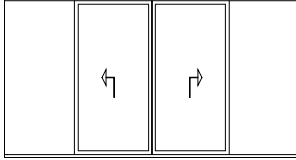

Schema | Type T2

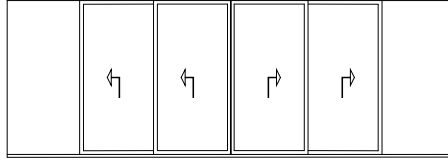

Schema | Type T3

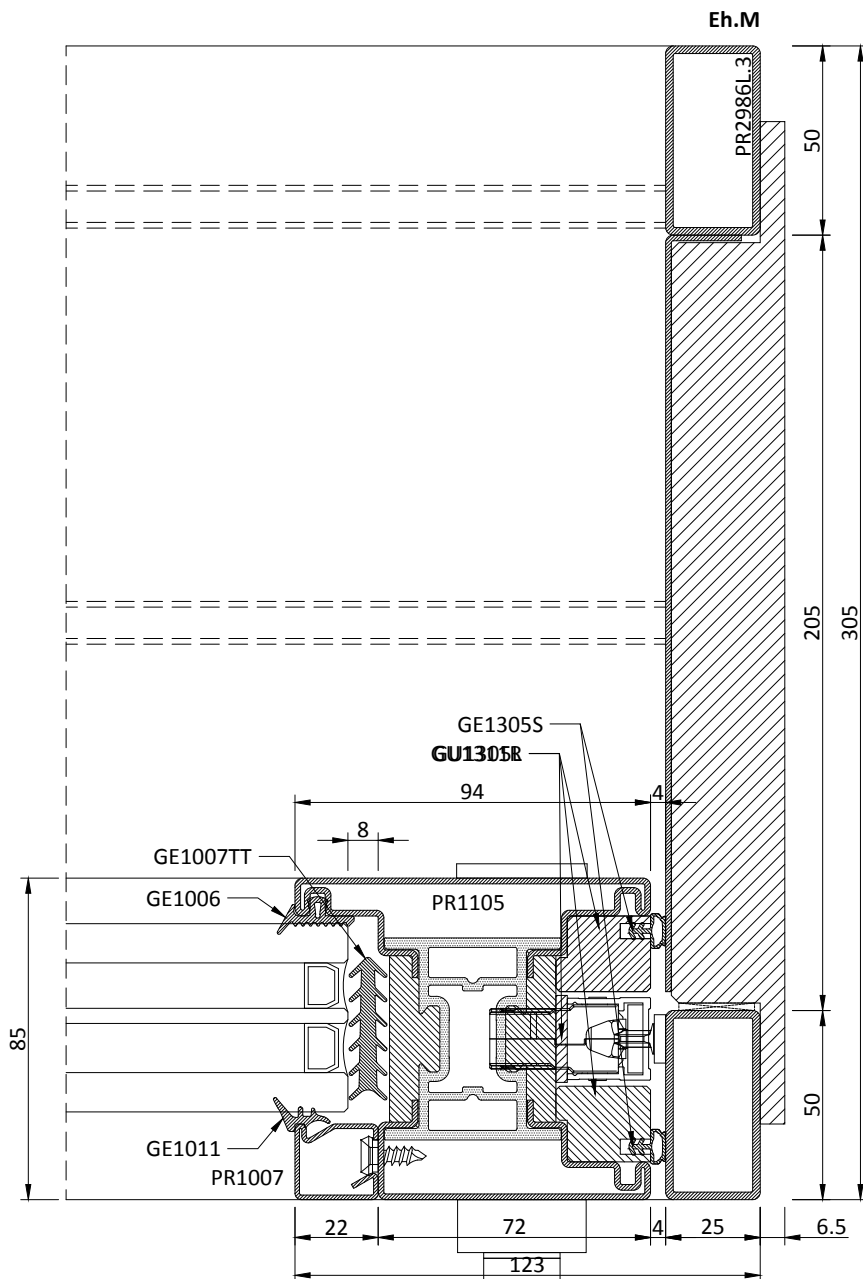
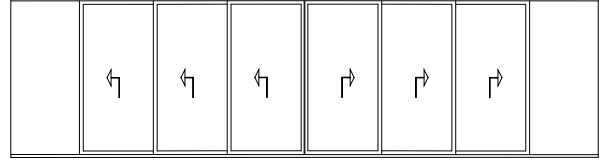

Schema | Type S1

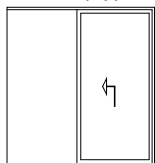

Schema | Type S2

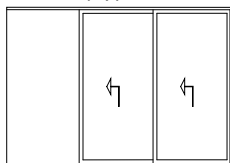

Schema | Type S3

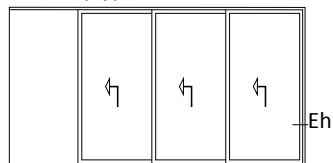

Schema | Type T1

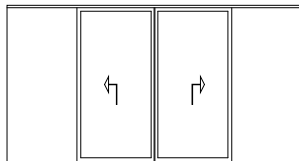

Schema | Type T2

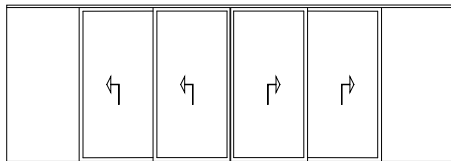

Schema | Type T3

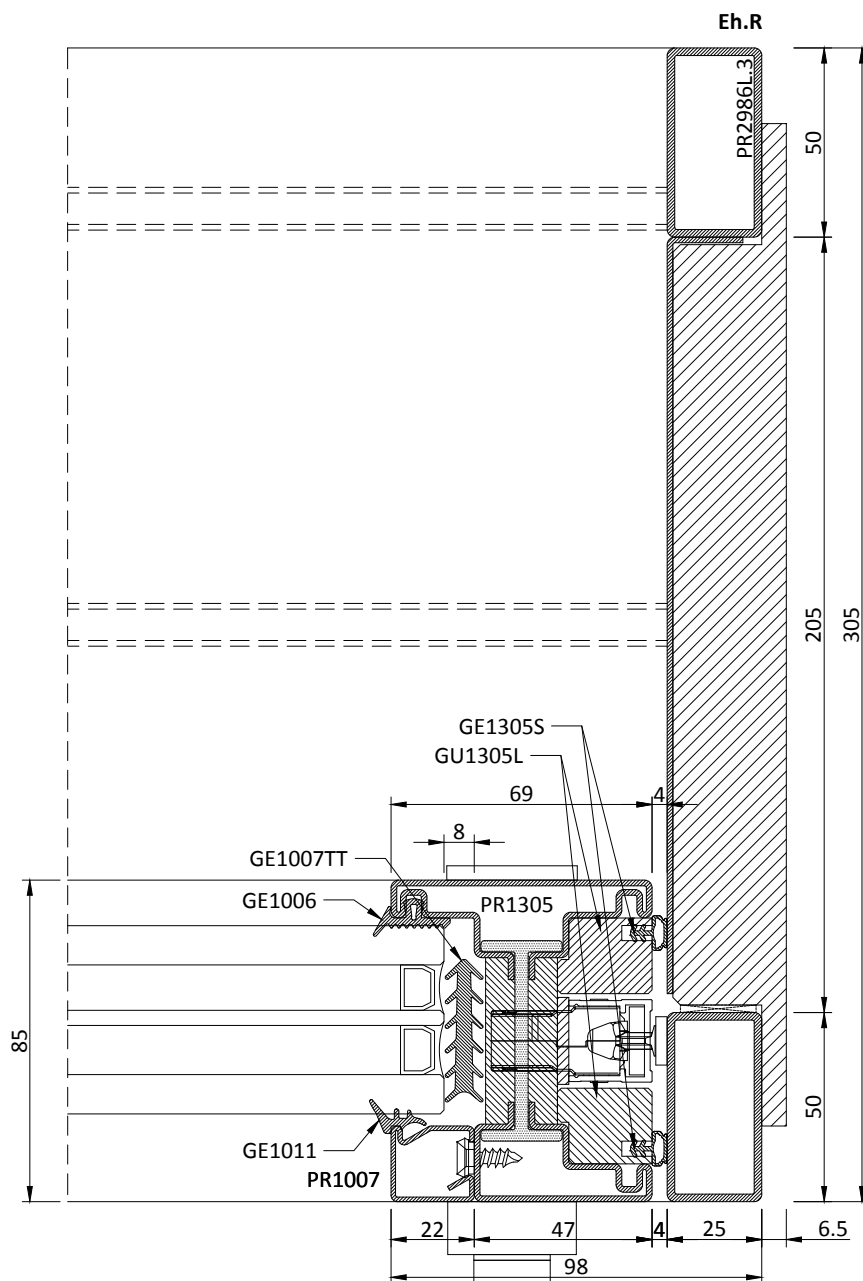
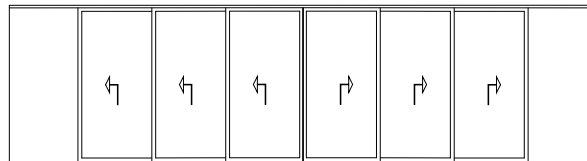

Schema | Type S1

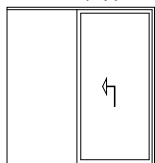

Schema | Type S2

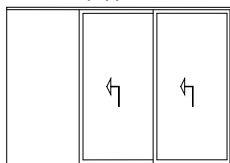

Schema | Type S3

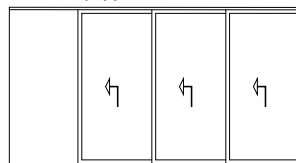

Schema | Type T1

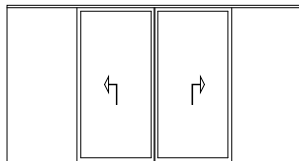

Schema | Type T2

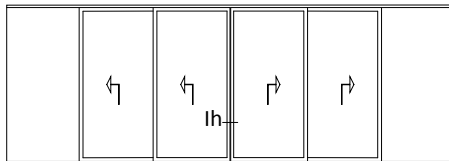

Schema | Type T3

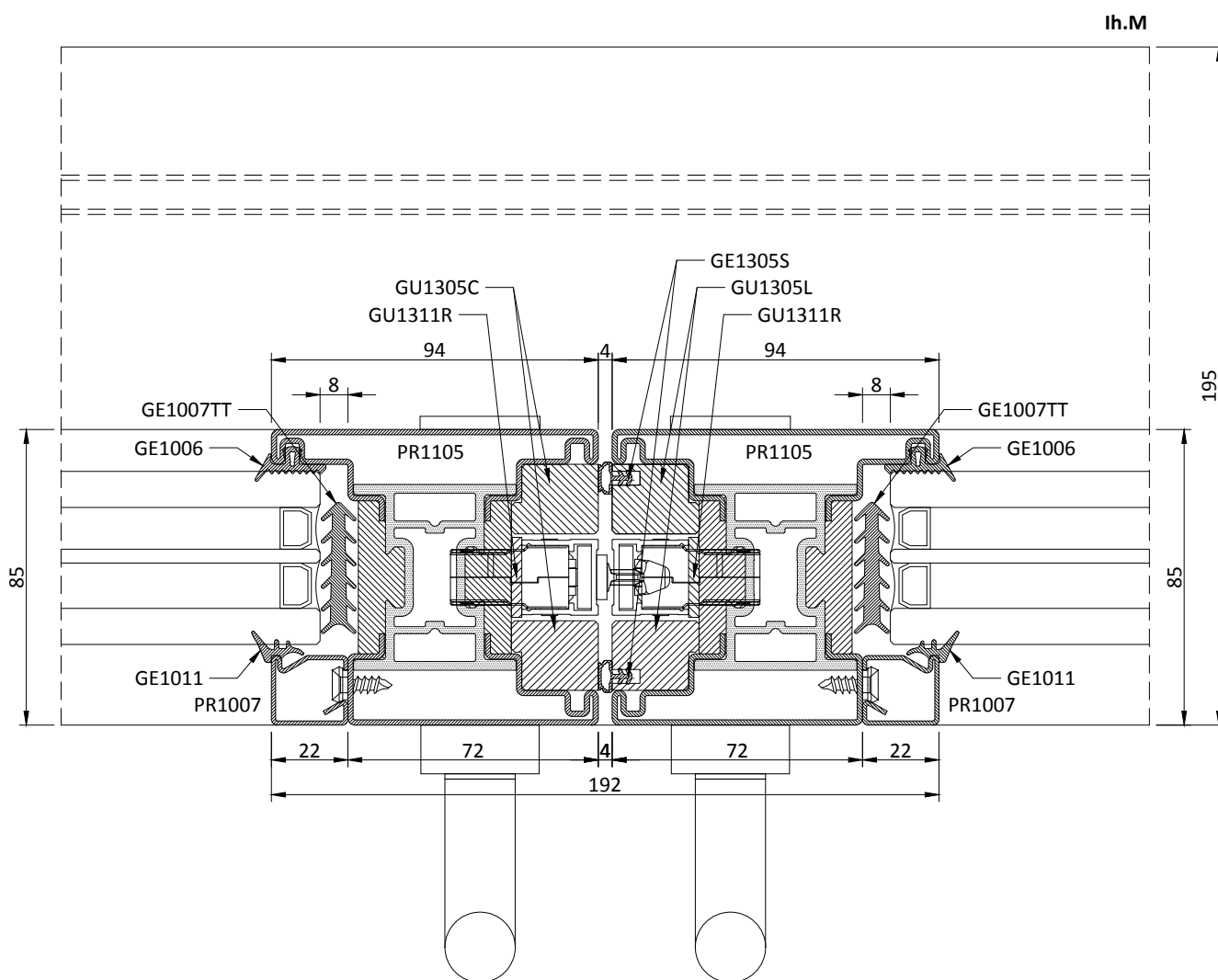
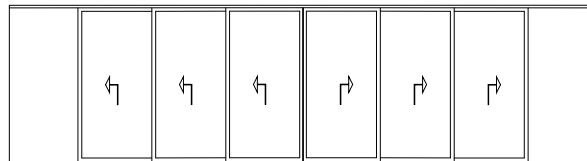

Schema | Type S1

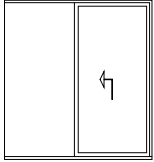

Schema | Type S2

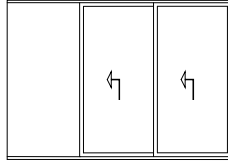

Schema | Type S3

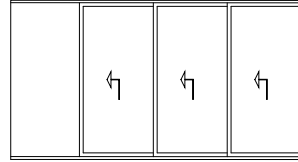

Schema | Type T1

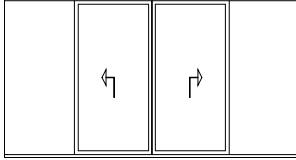

Schema | Type T2

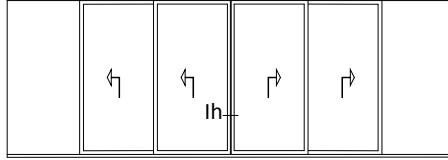

Schema | Type T3

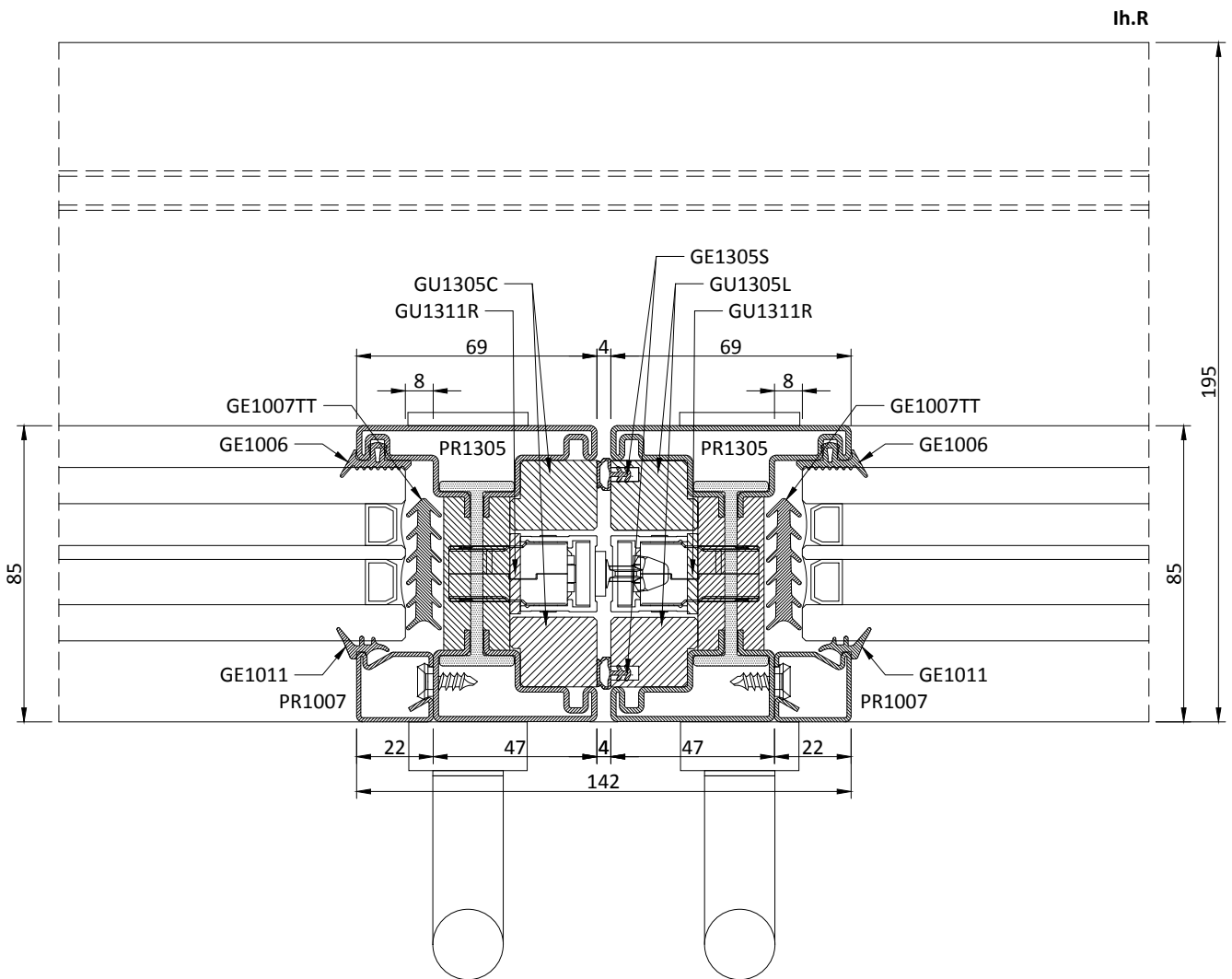
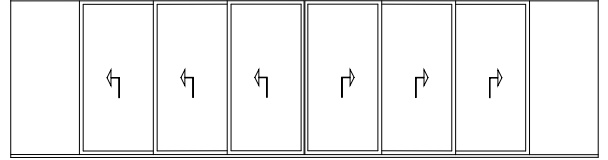

Schema | Type S1

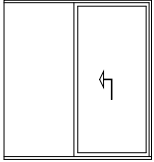

Schema | Type S2

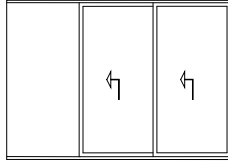

Schema | Type S3

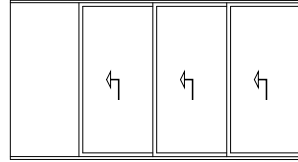

Schema | Type T1

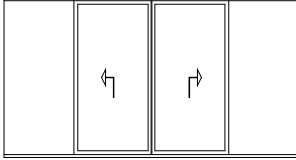

Schema | Type T2

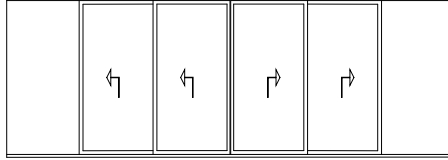

Schema | Type T3

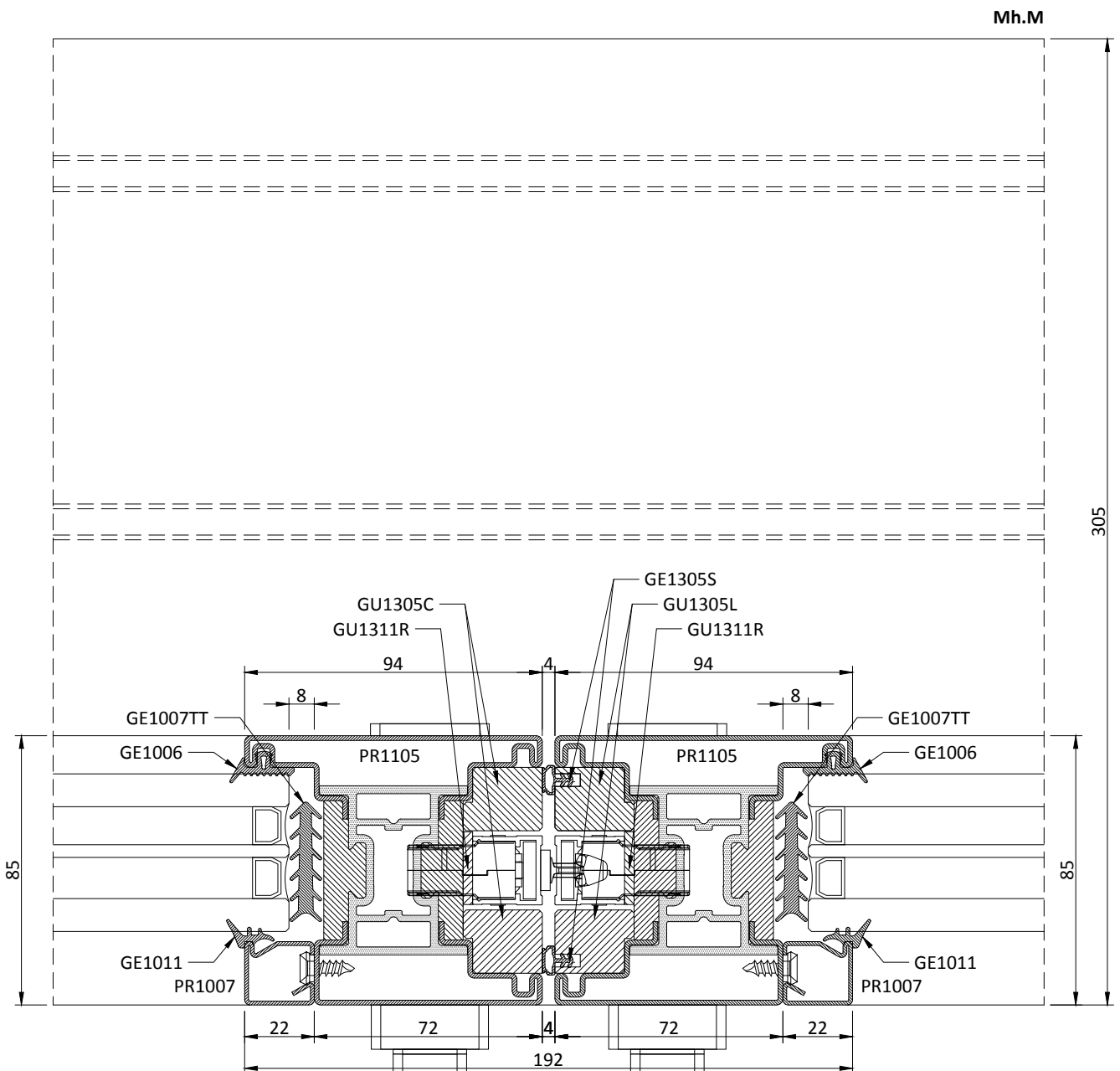
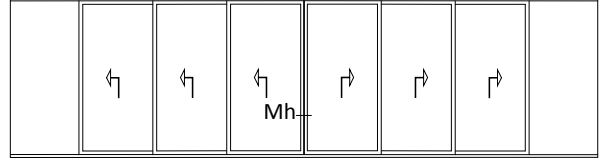

Schema | Type S1

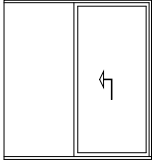

Schema | Type S2

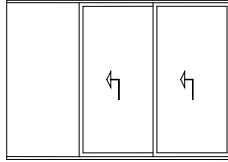

Schema | Type S3

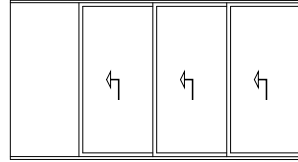

Schema | Type T1

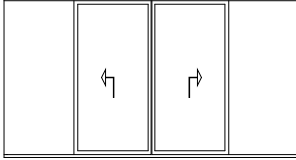

Schema | Type T2

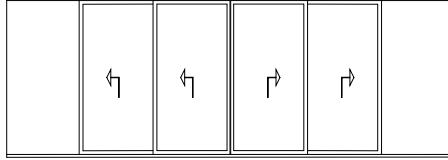

Schema | Type T3

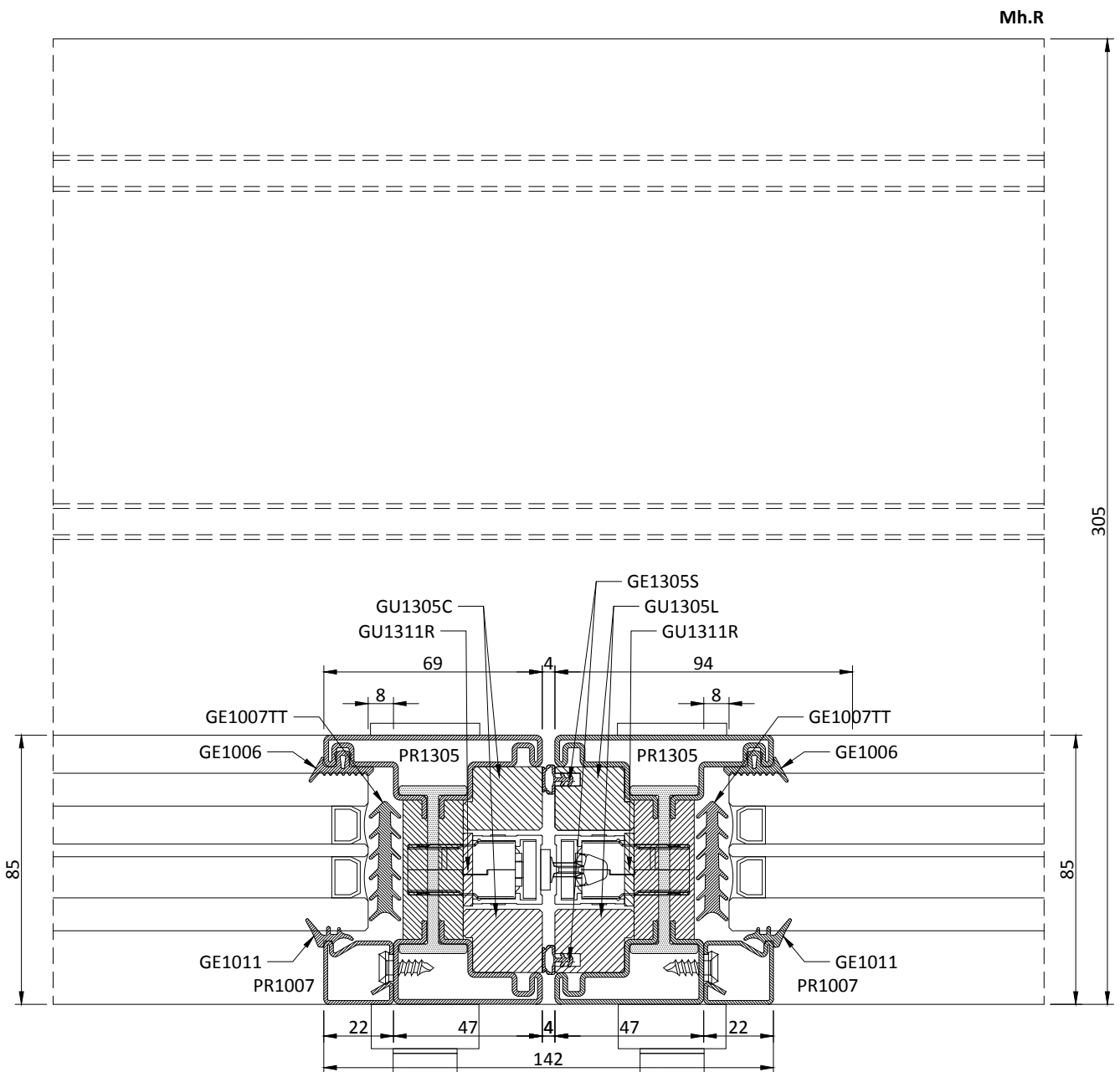
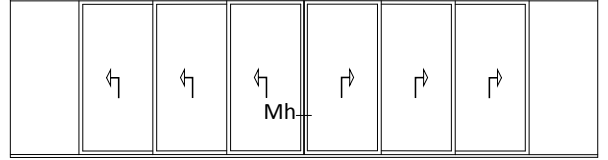

Schema | Type S1

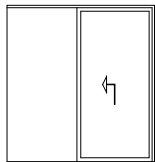

Schema | Type S2

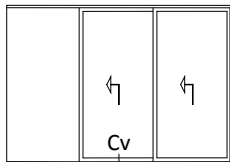

Schema | Type S3

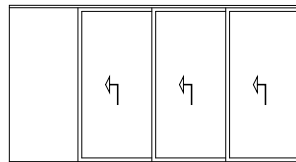

Schema | Type T1

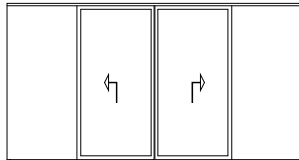

Schema | Type T2

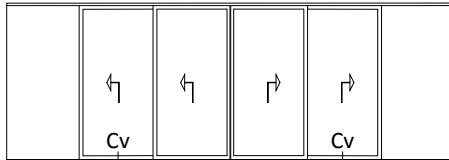

Schema | Type T3

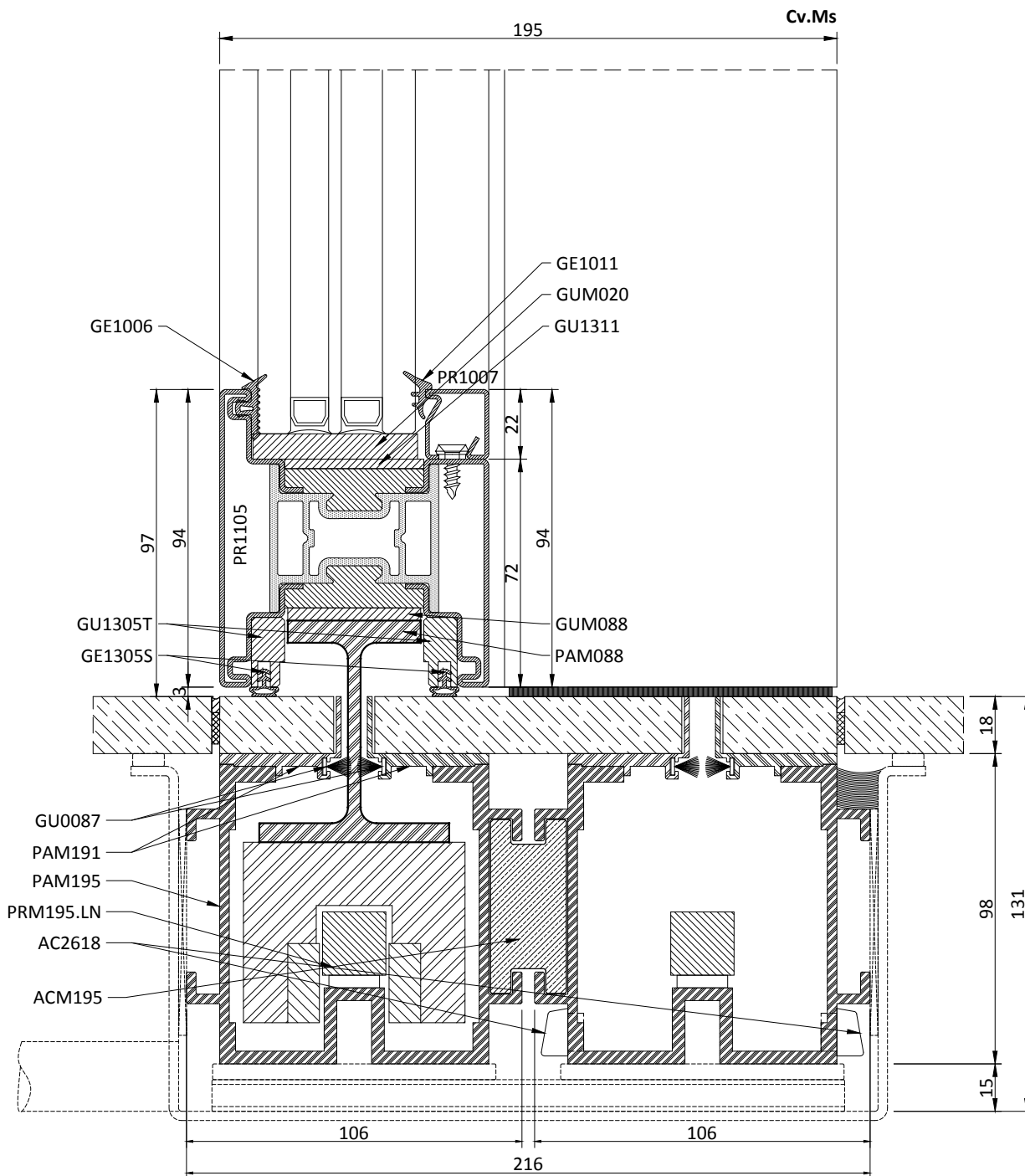
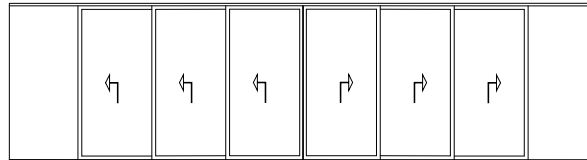

Schema | Type S1

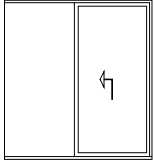

Schema | Type S2

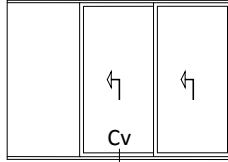

Schema | Type S3

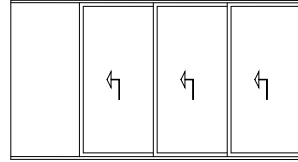

Schema | Type T1

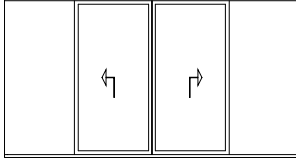

Schema | Type T2

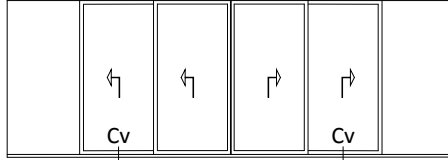

Schema | Type T3

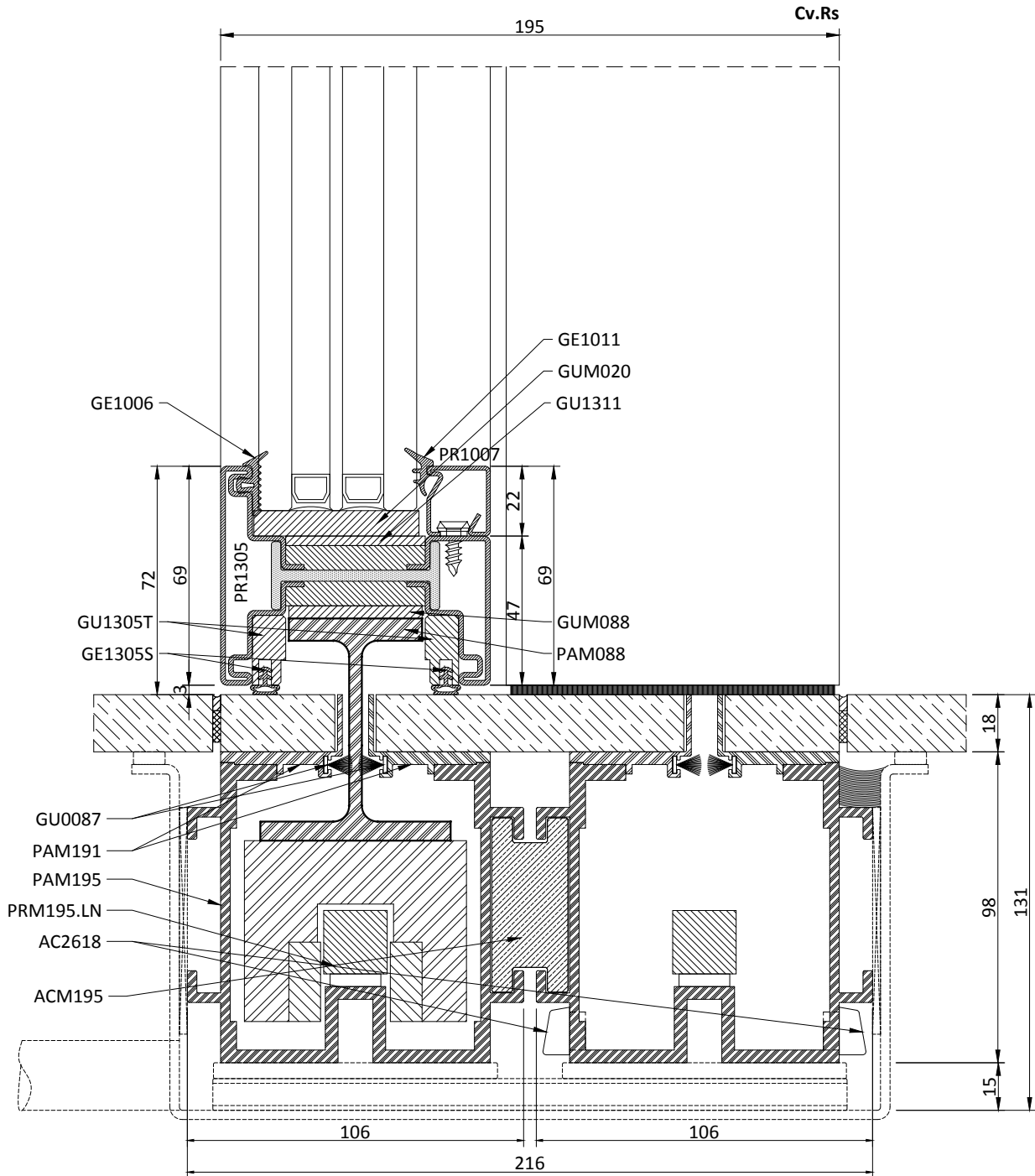
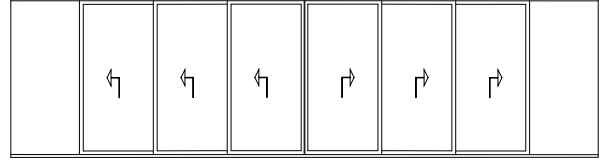



Schema | Type S1

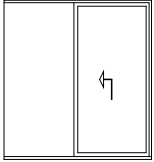

Schema | Type S2

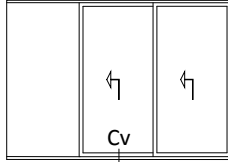

Schema | Type S3

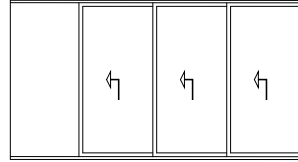

Schema | Type T1

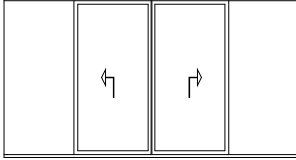

Schema | Type T2

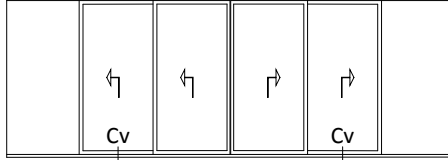

Schema | Type T3

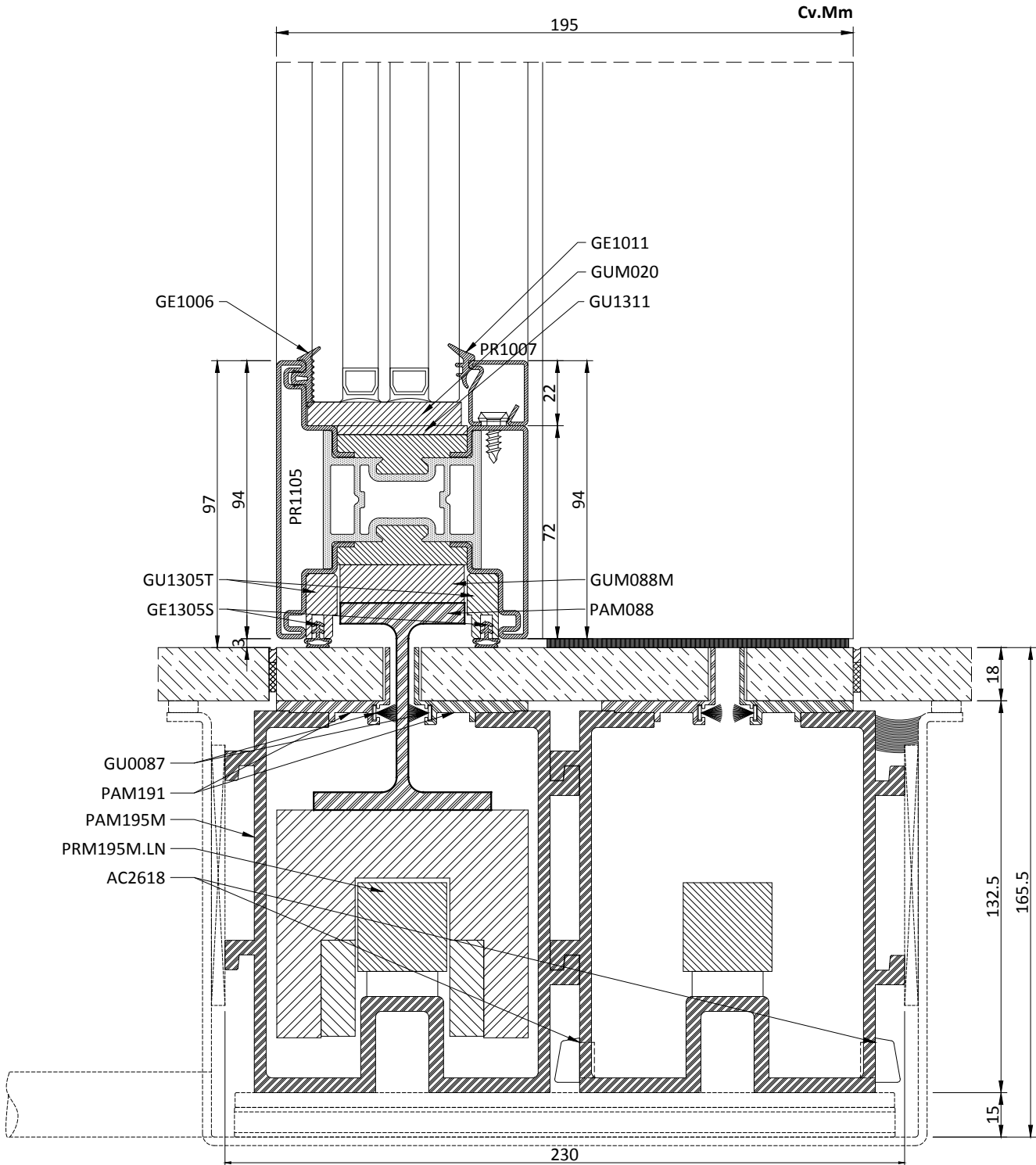
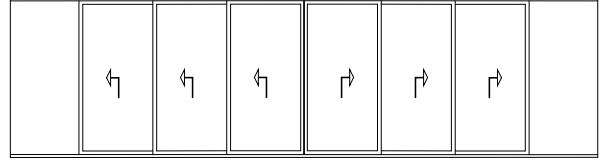

Schema | Type S1

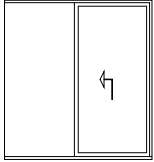

Schema | Type S2

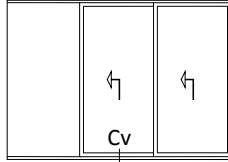

Schema | Type S3

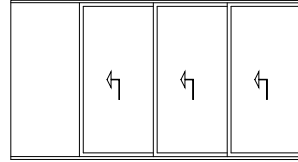

Schema | Type T1

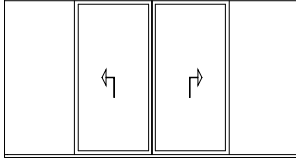

Schema | Type T2

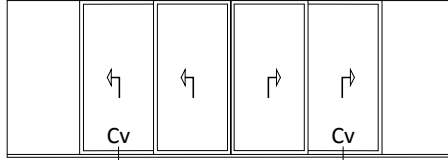

Schema | Type T3

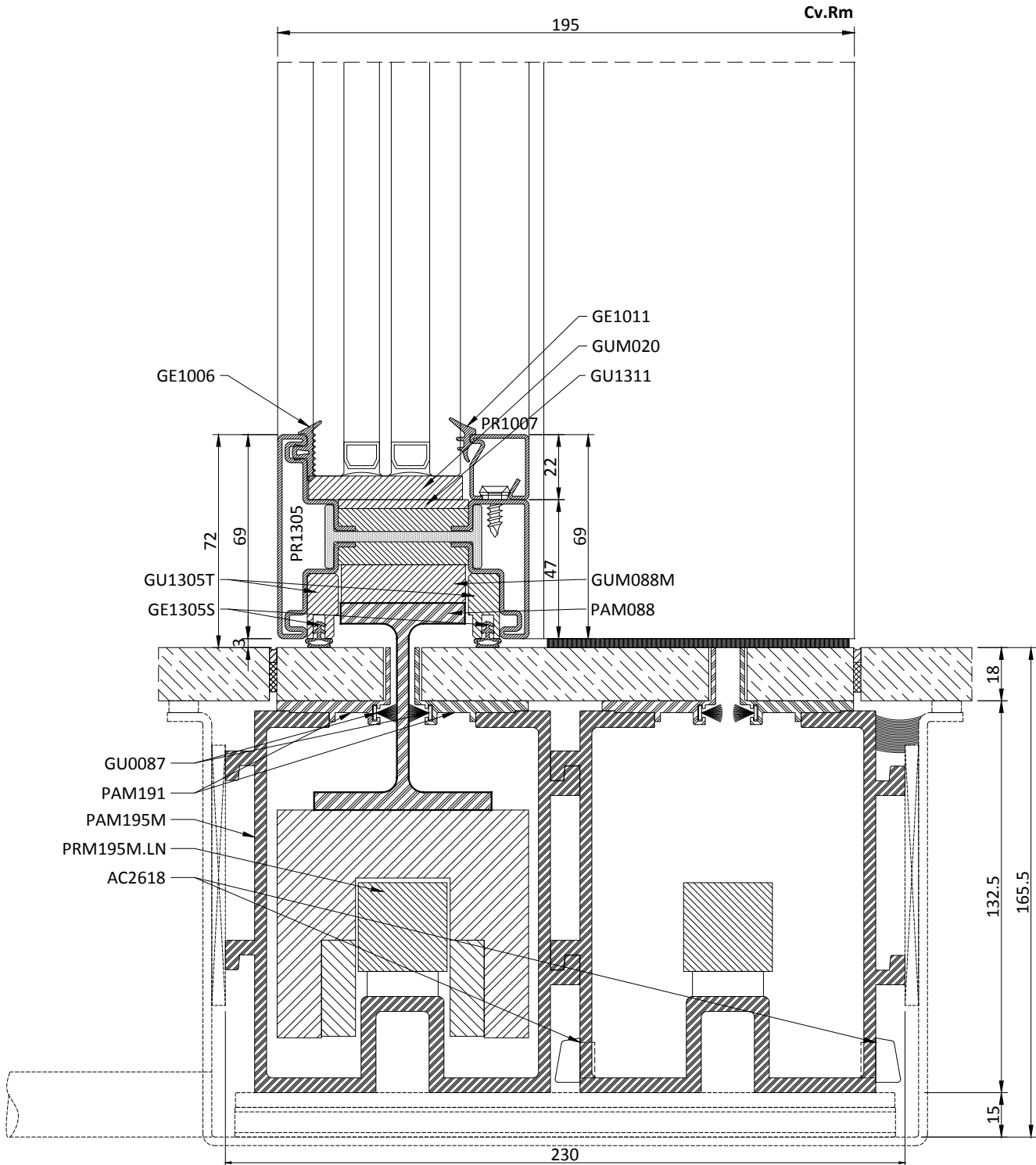
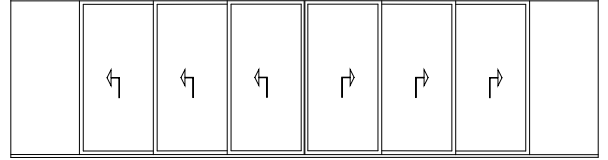

Schema | Type S1

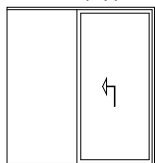

Schema | Type S2

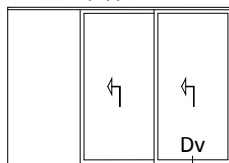

Schema | Type S3

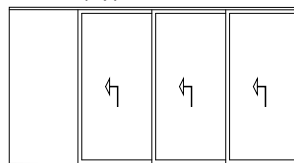

Schema | Type T1

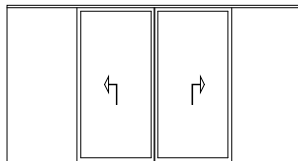

Schema | Type T2

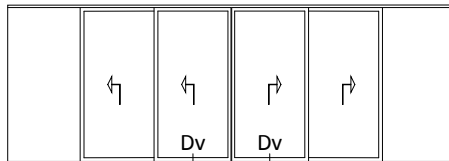

Schema | Type T3

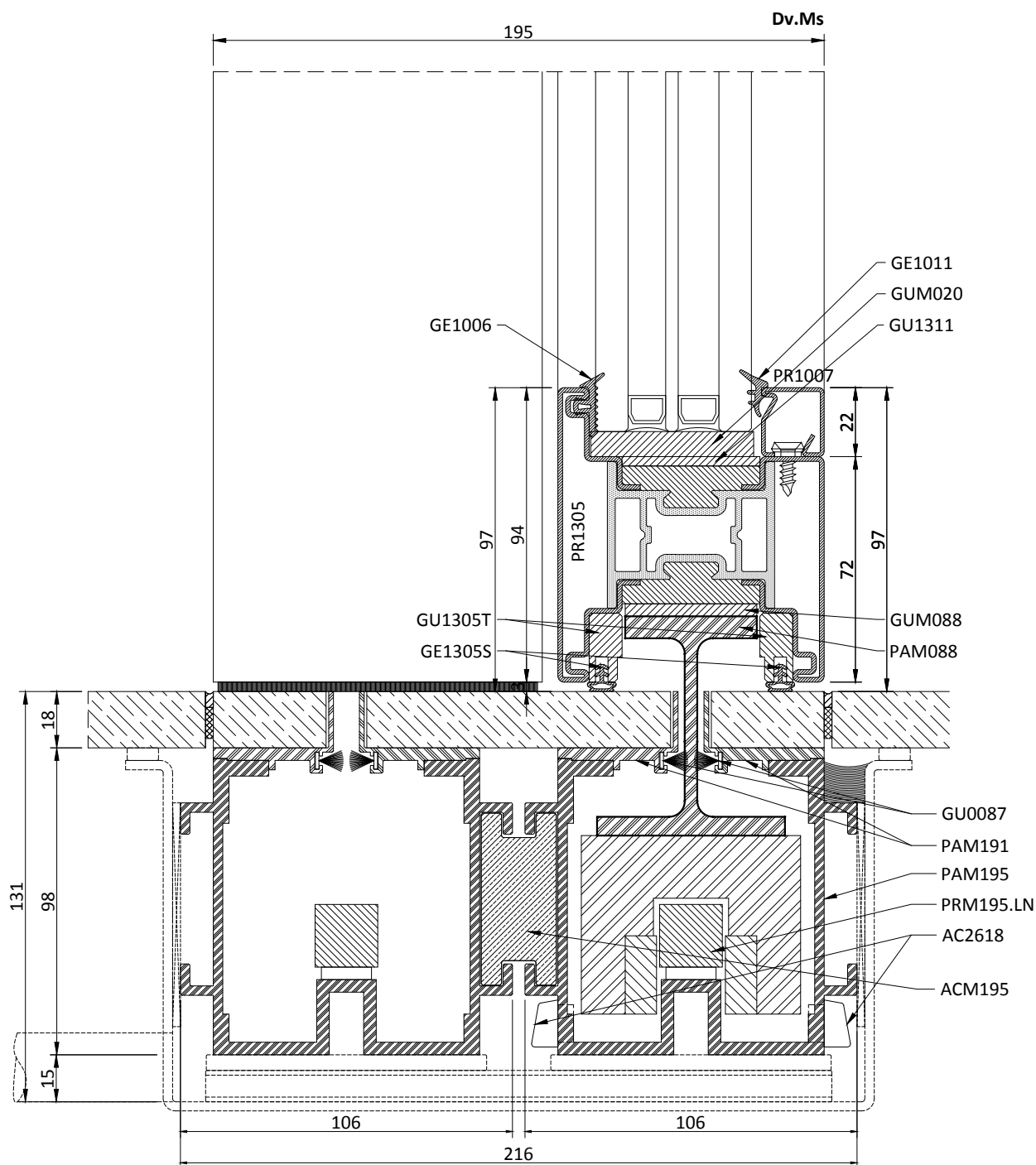
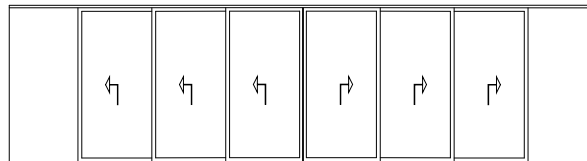

Schema | Type S1

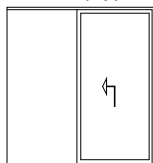

Schema | Type S2

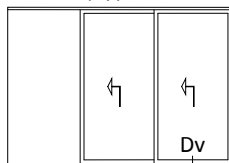

Schema | Type S3

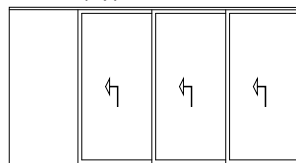

Schema | Type T1

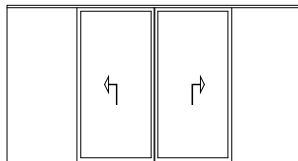

Schema | Type T2

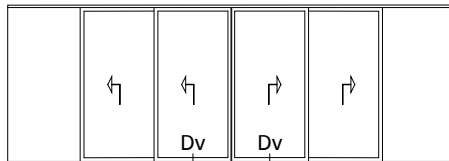

Schema | Type T3

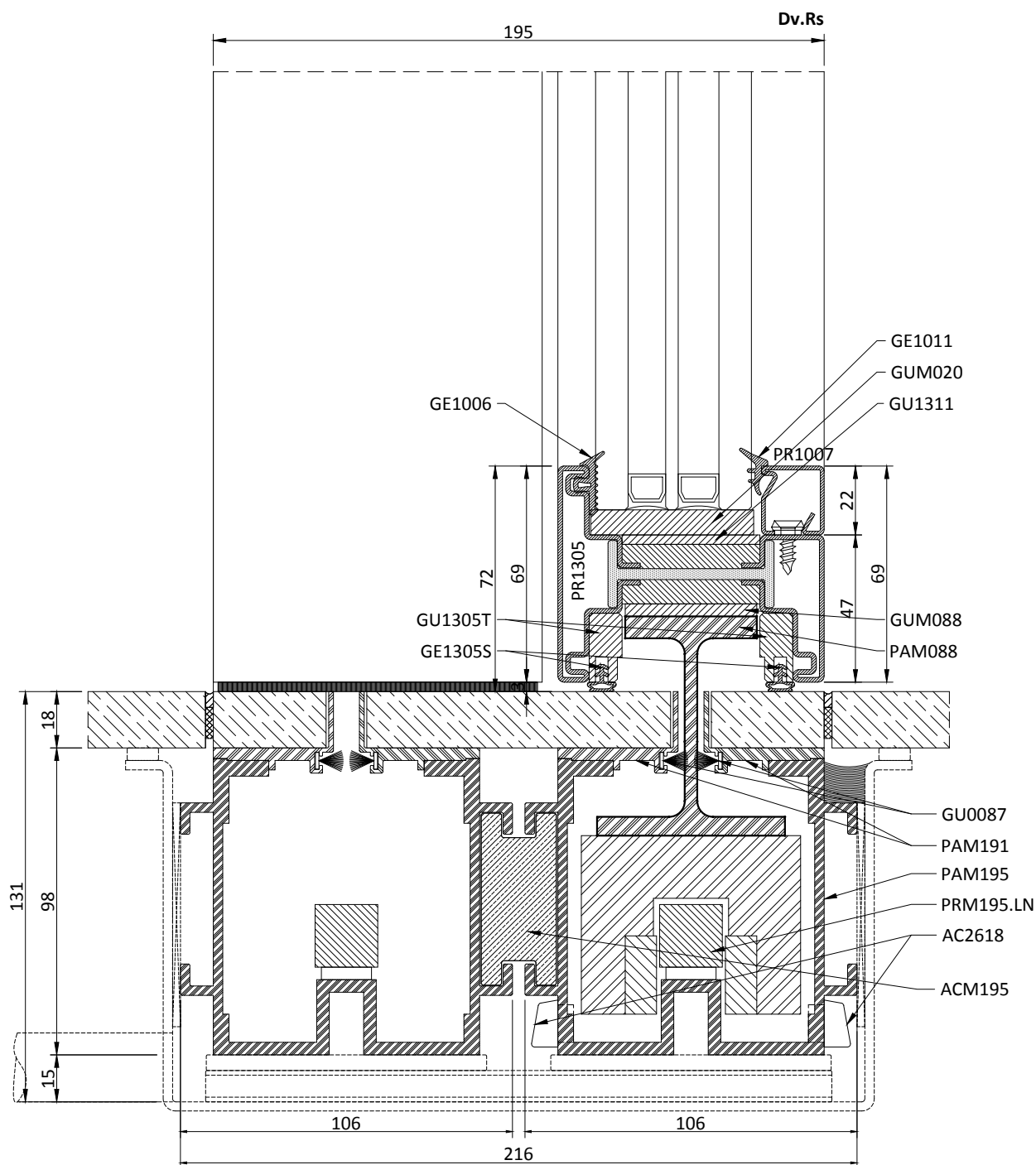
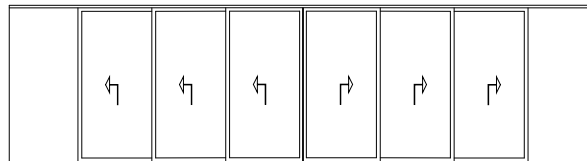

Schema | Type S1

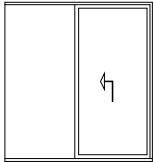

Schema | Type S2

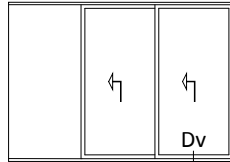

Schema | Type S3

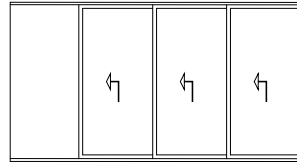

Schema | Type T1

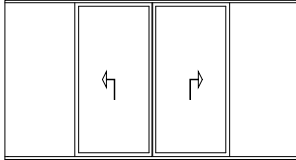

Schema | Type T2

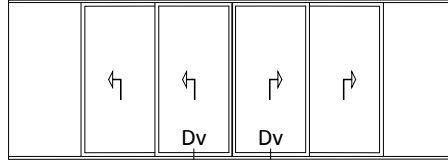

Schema | Type T3

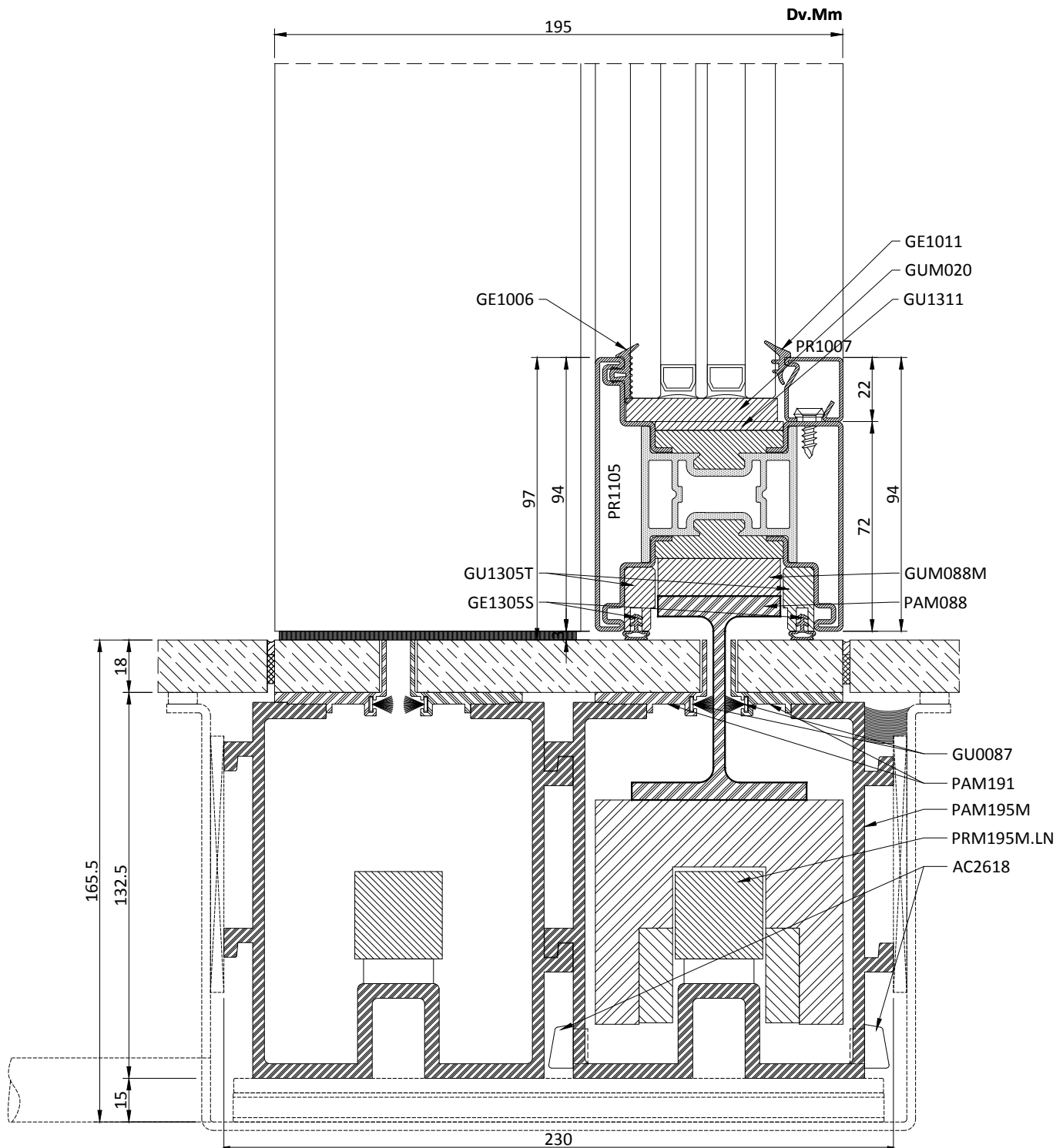
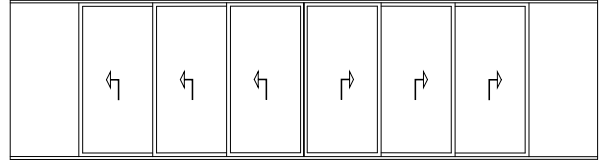

Schema | Type S1

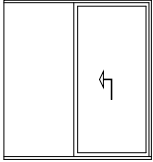

Schema | Type S2

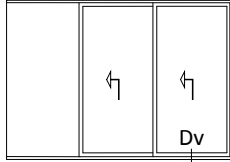

Schema | Type S3

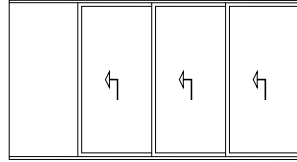

Schema | Type T1

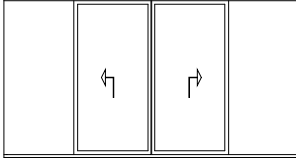

Schema | Type T2

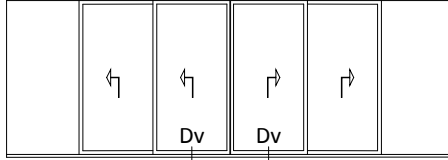

Schema | Type T3

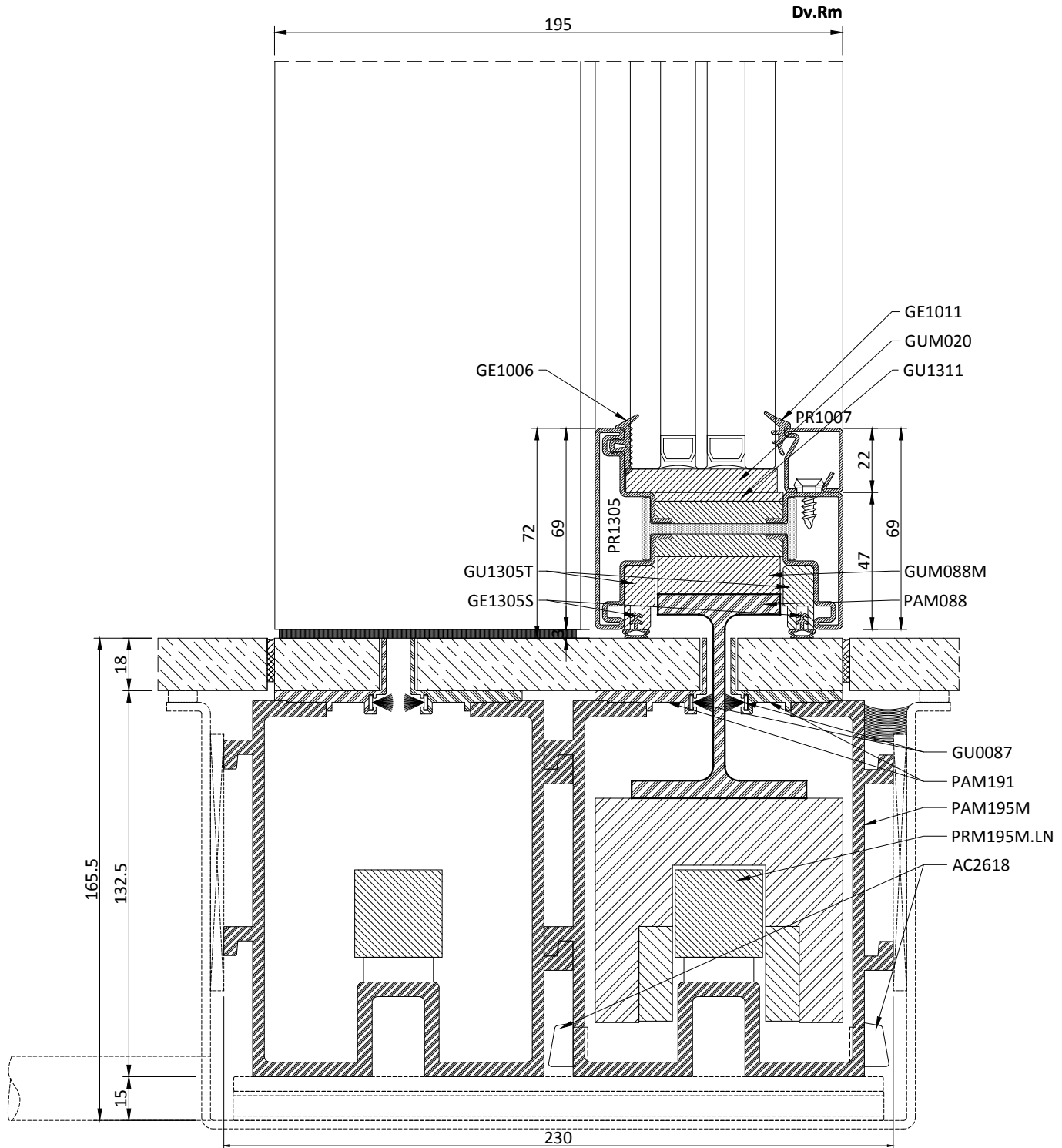
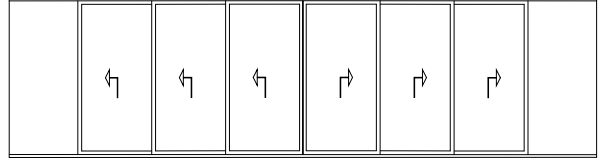

Schema | Type S1

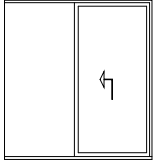

Schema | Type S2

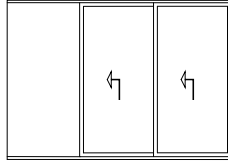

Schema | Type S3

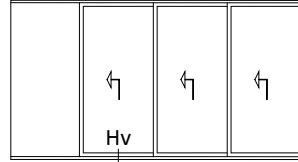

Schema | Type T1

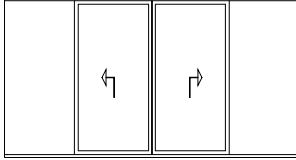

Schema | Type T2

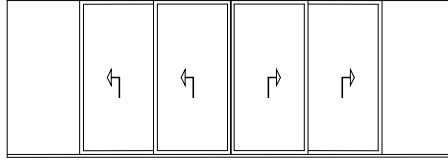

Schema | Type T3

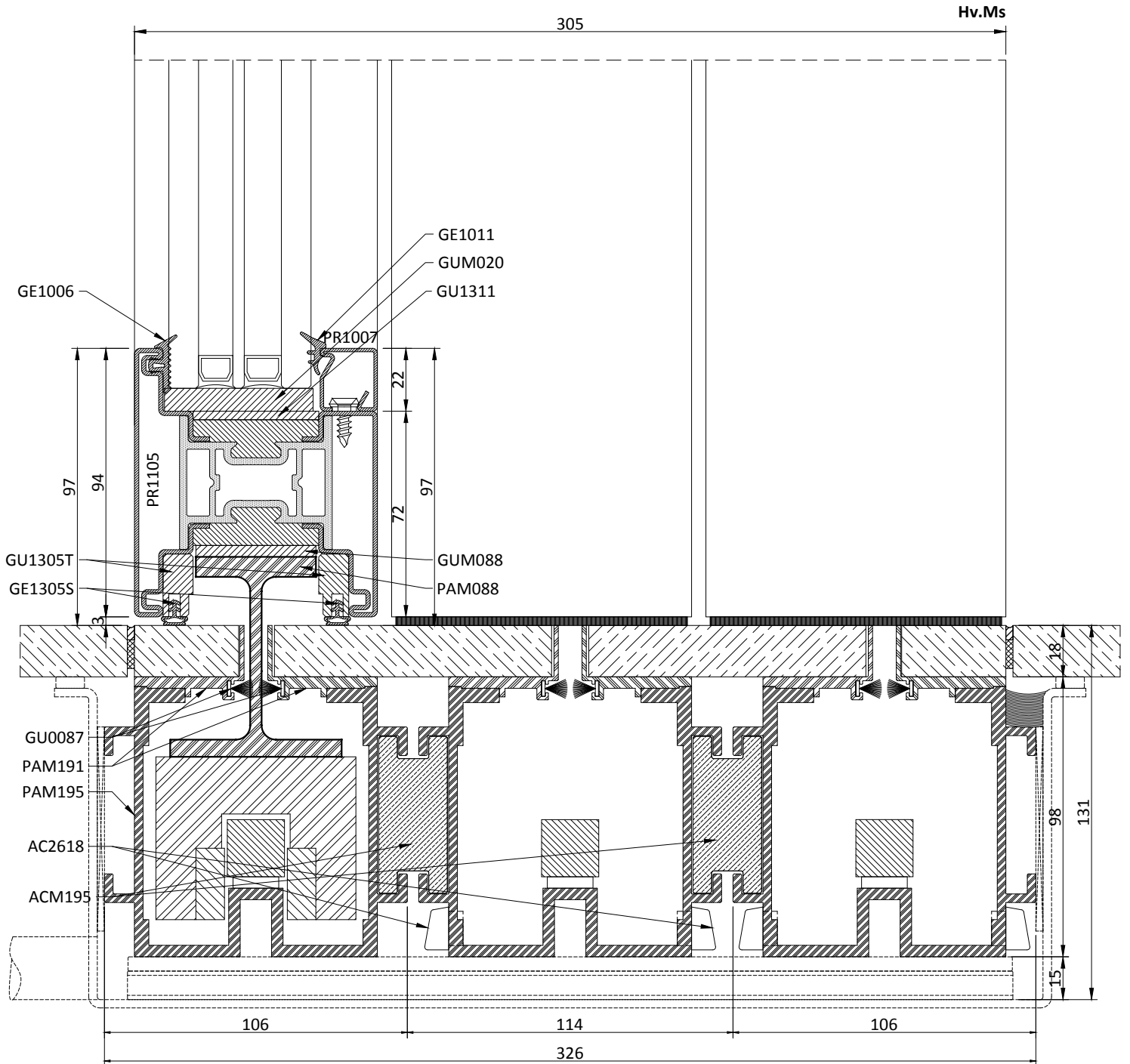
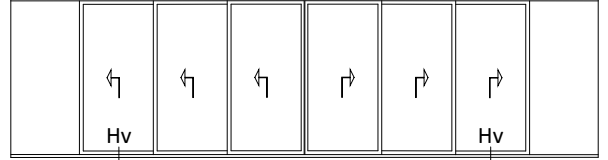

Schema | Type S1

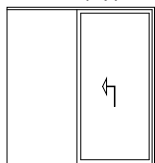

Schema | Type S2

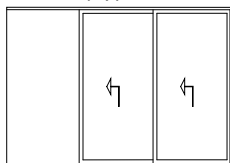

Schema | Type S3

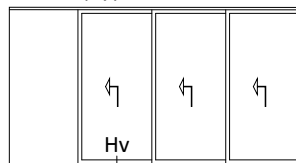

Schema | Type T1

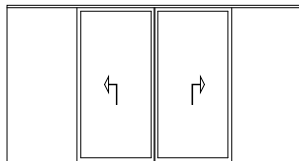

Schema | Type T2

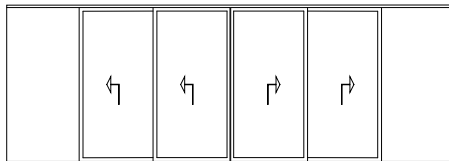

Schema | Type T3

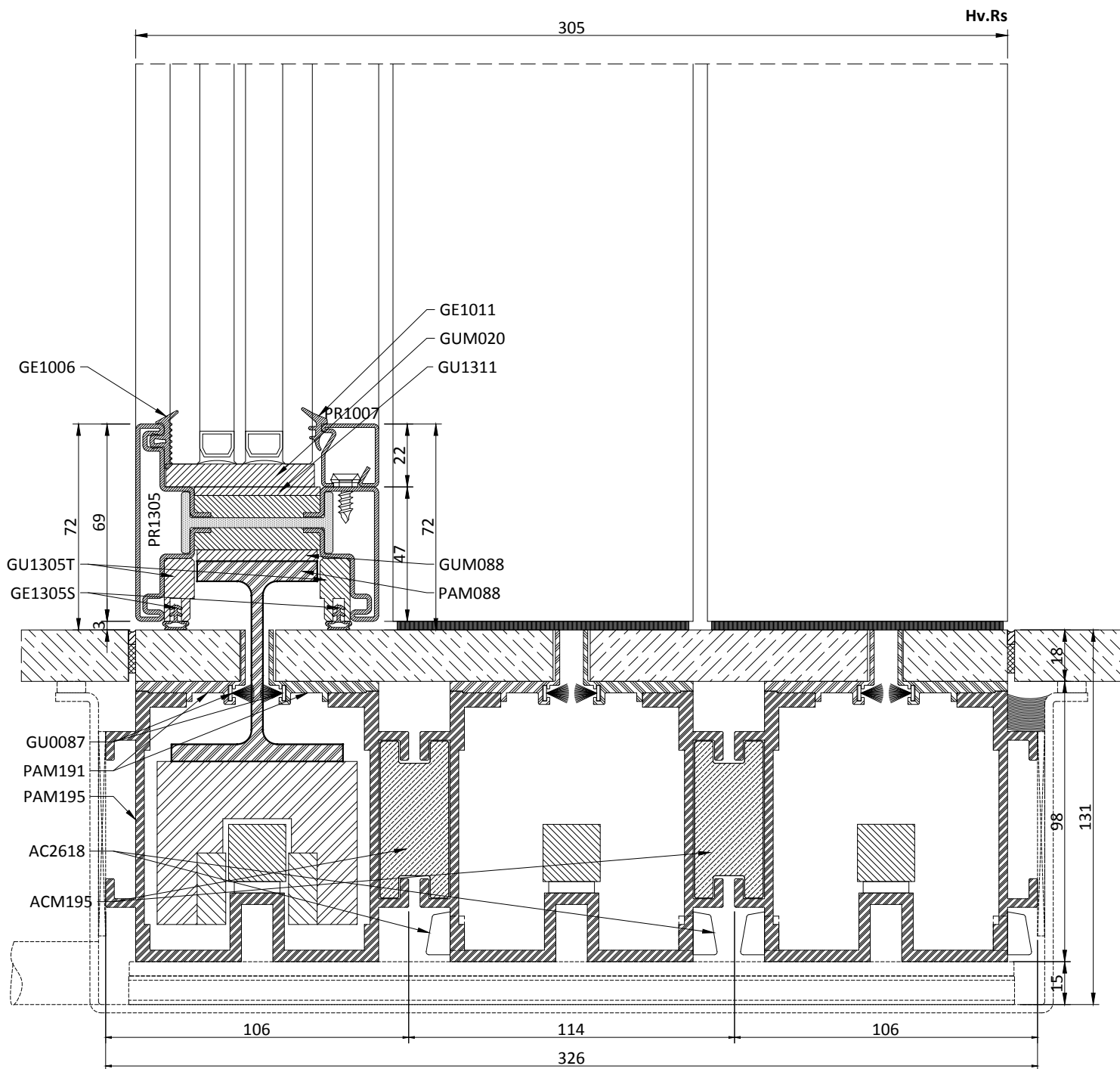
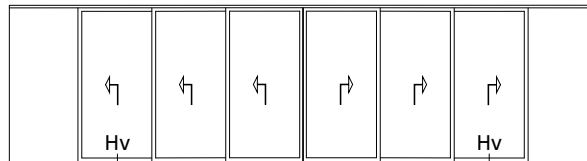



Schema | Type S1

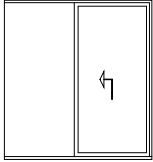

Schema | Type S2

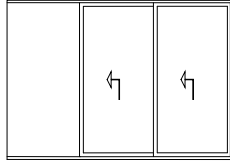

Schema | Type S3

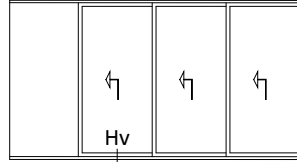

Schema | Type T1

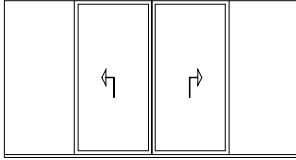

Schema | Type T2

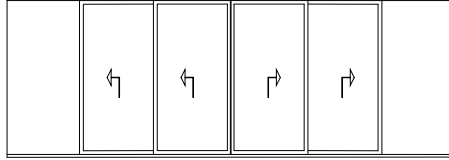

Schema | Type T3

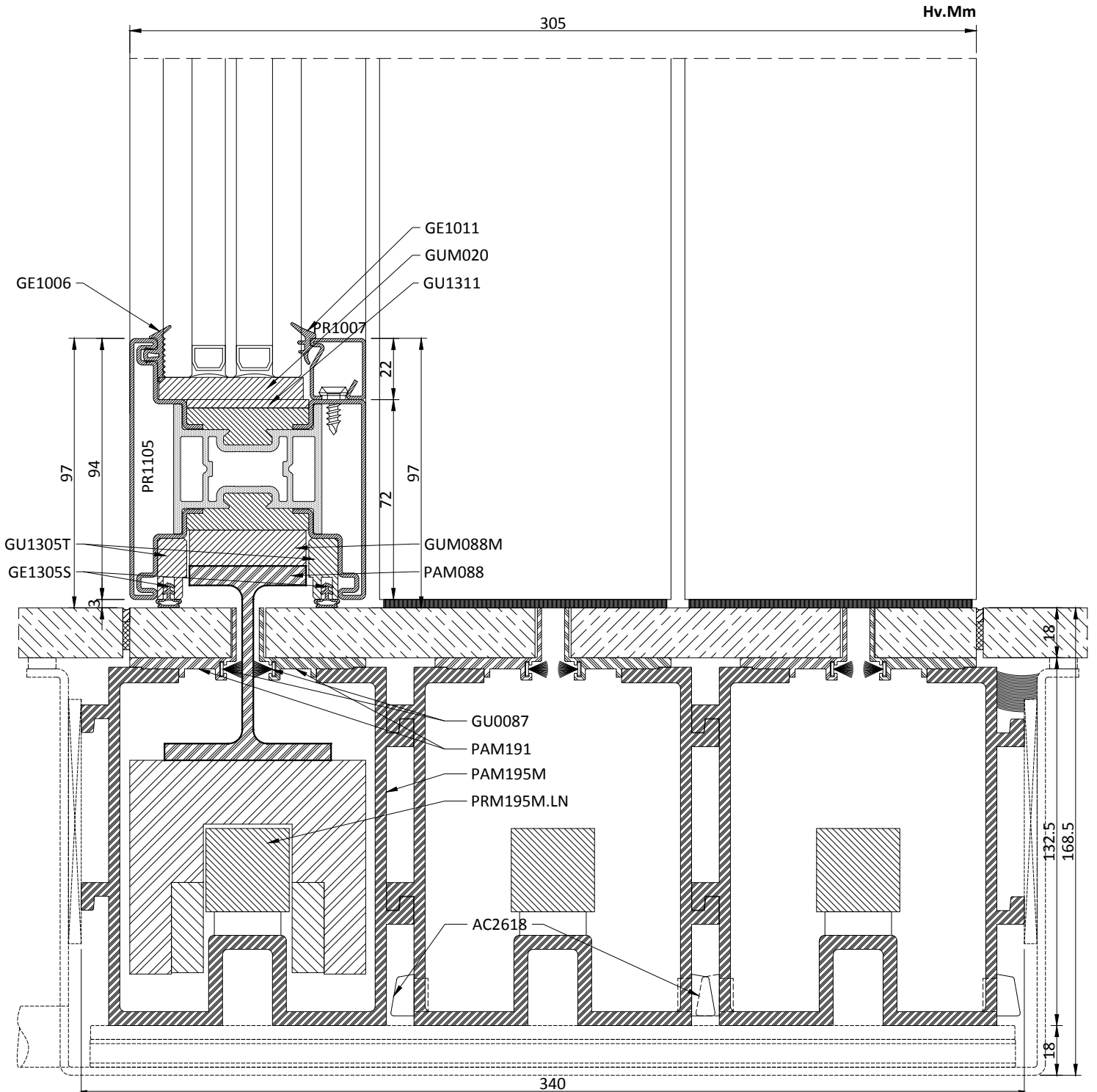
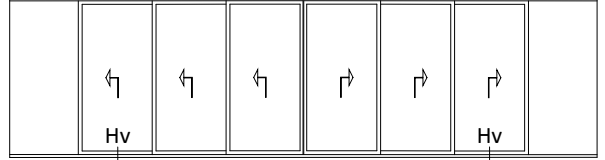

Schema | Type S1

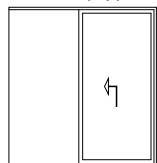

Schema | Type S2

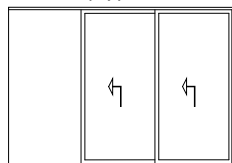

Schema | Type S3

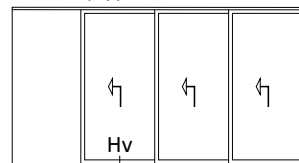

Schema | Type T1

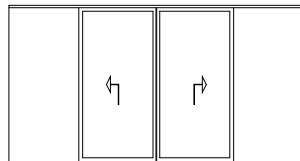

Schema | Type T2

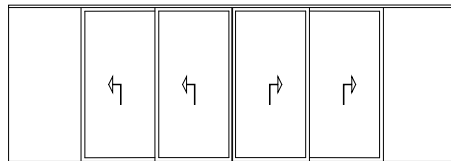

Schema | Type T3

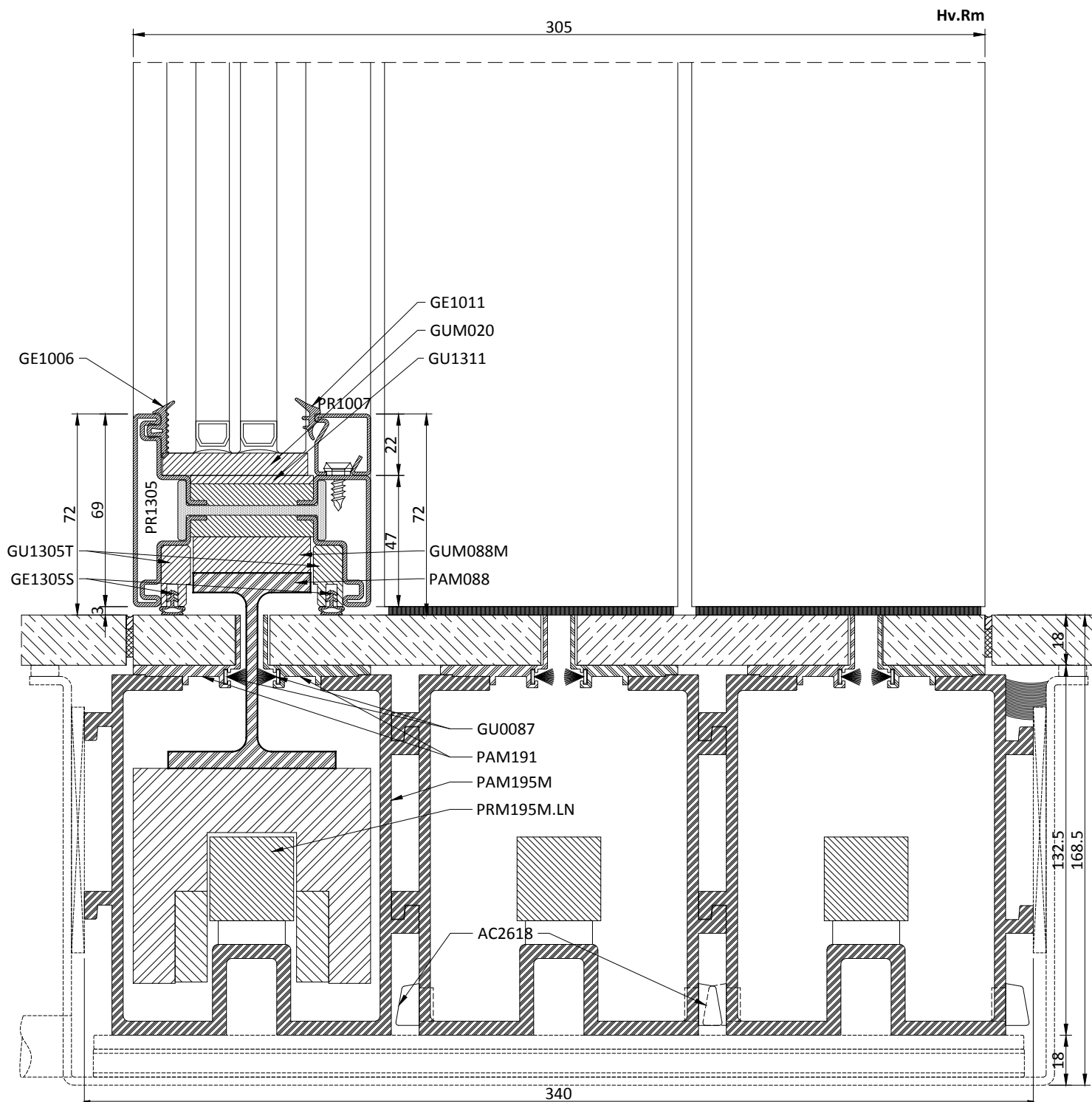
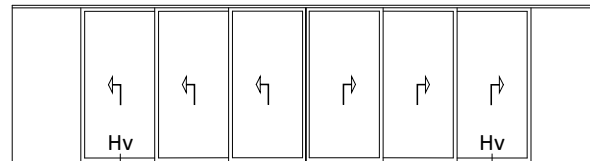

Schema | Type S1

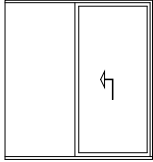

Schema | Type S2

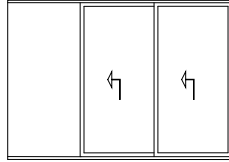

Schema | Type S3

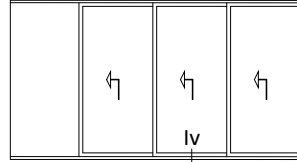

Schema | Type T1

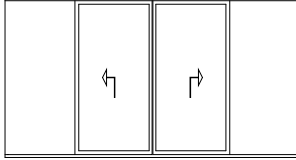

Schema | Type T2

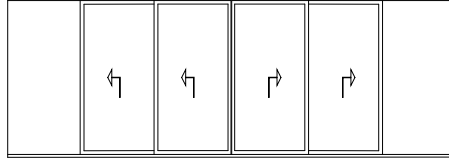

Schema | Type T3

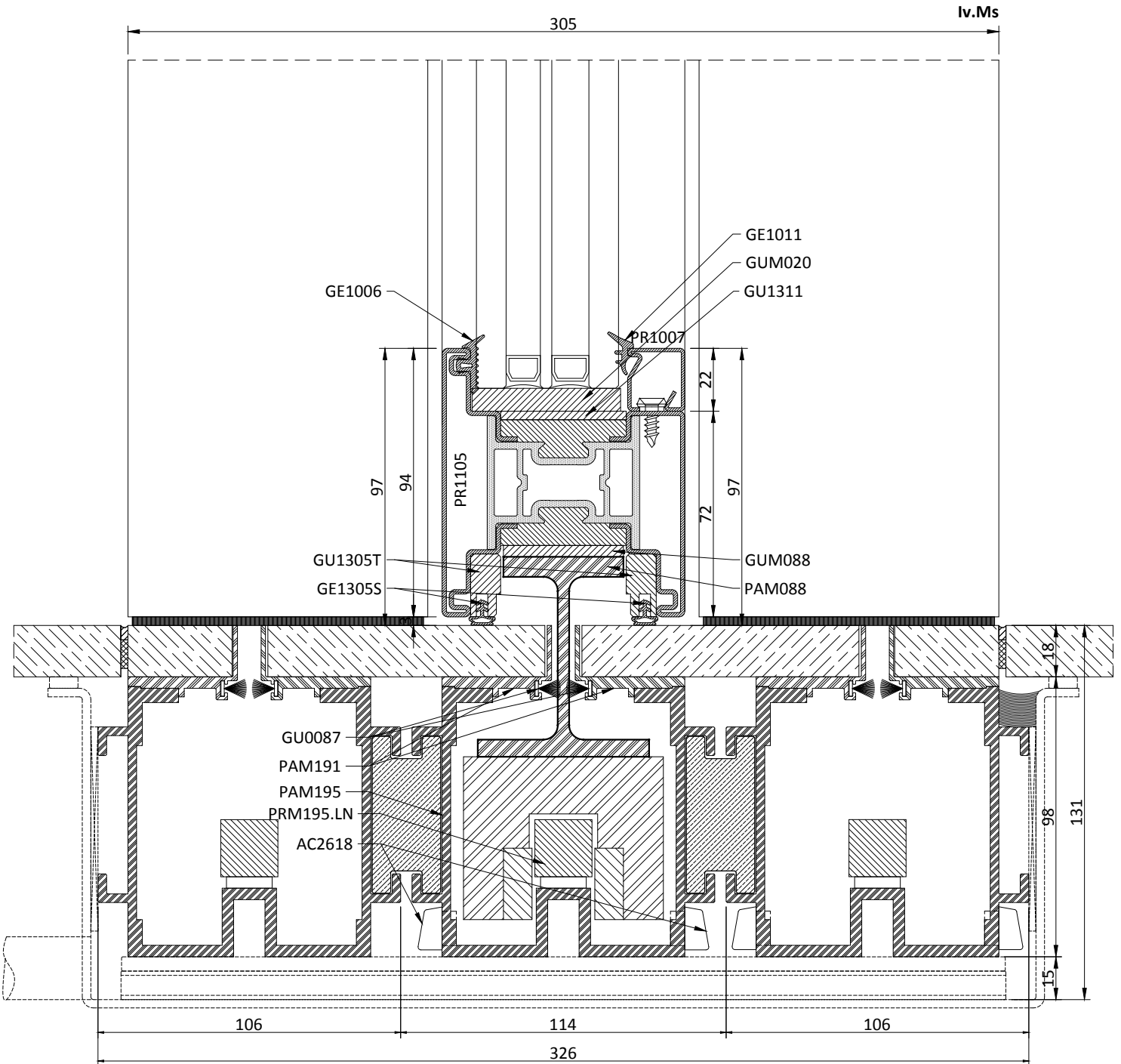
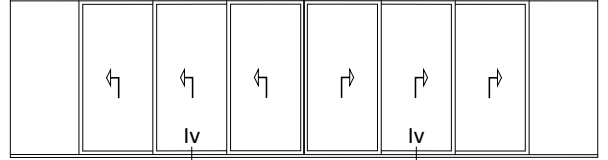

Schema | Type S1

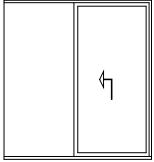

Schema | Type S2

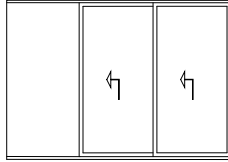

Schema | Type S3

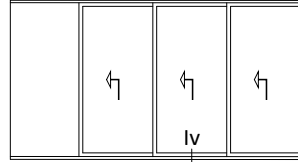

Schema | Type T1

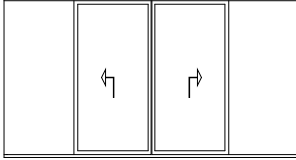

Schema | Type T2

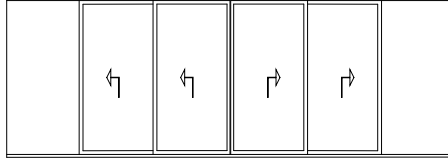

Schema | Type T3

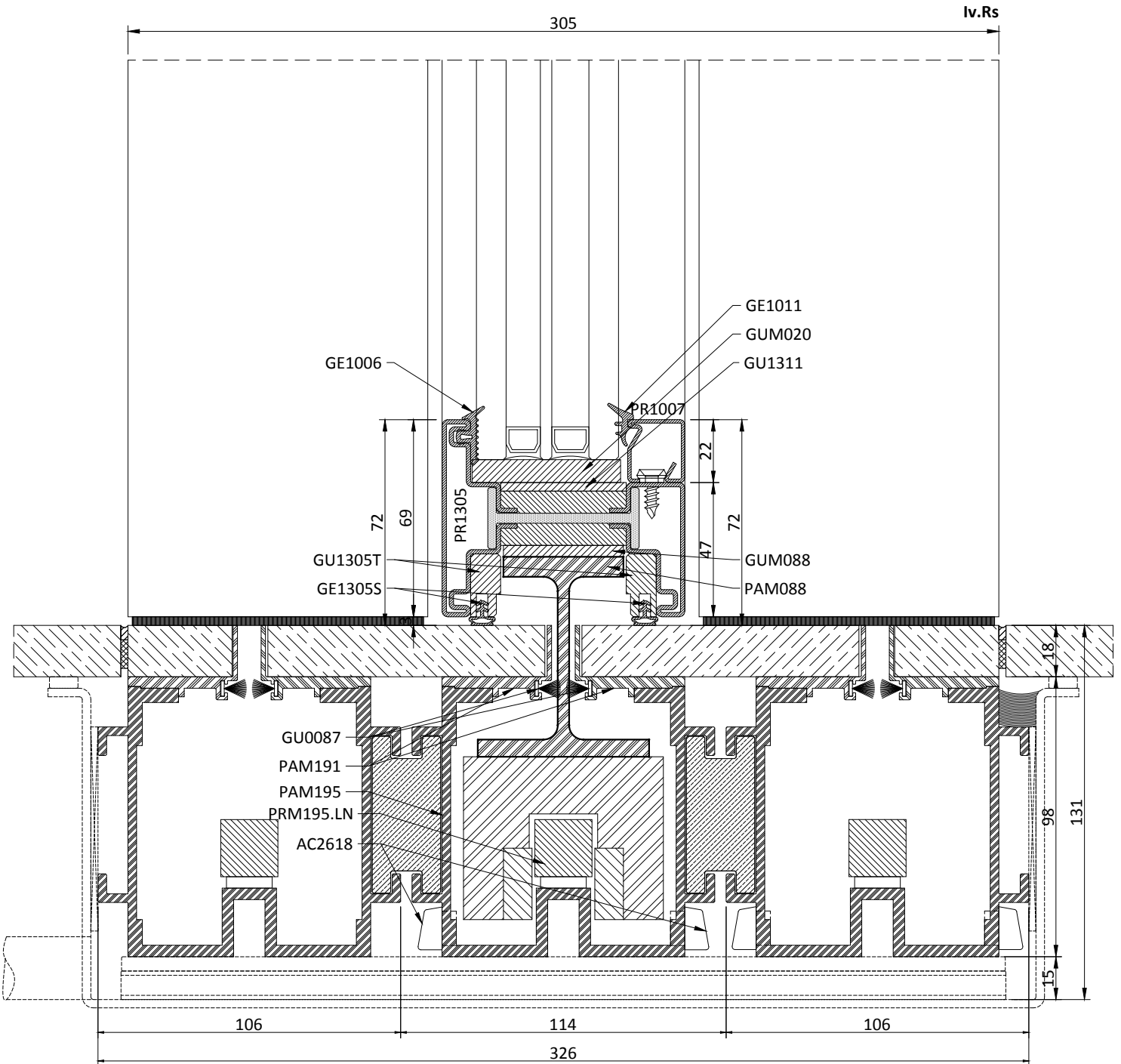
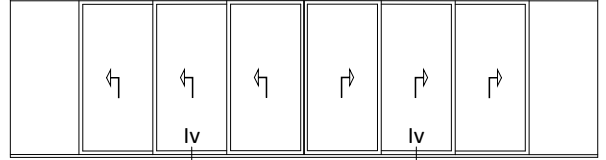

Schema | Type S1

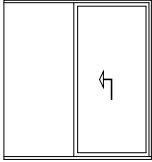

Schema | Type S2

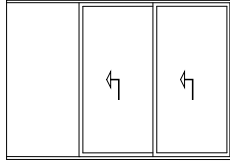

Schema | Type S3

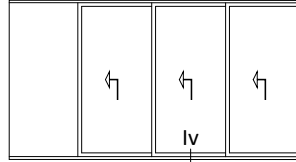

Schema | Type T1

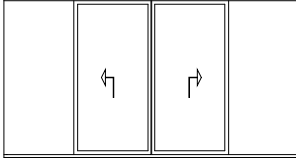

Schema | Type T2

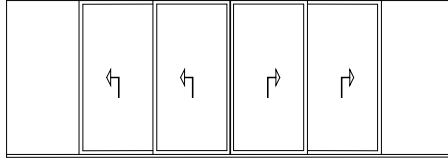

Schema | Type T3

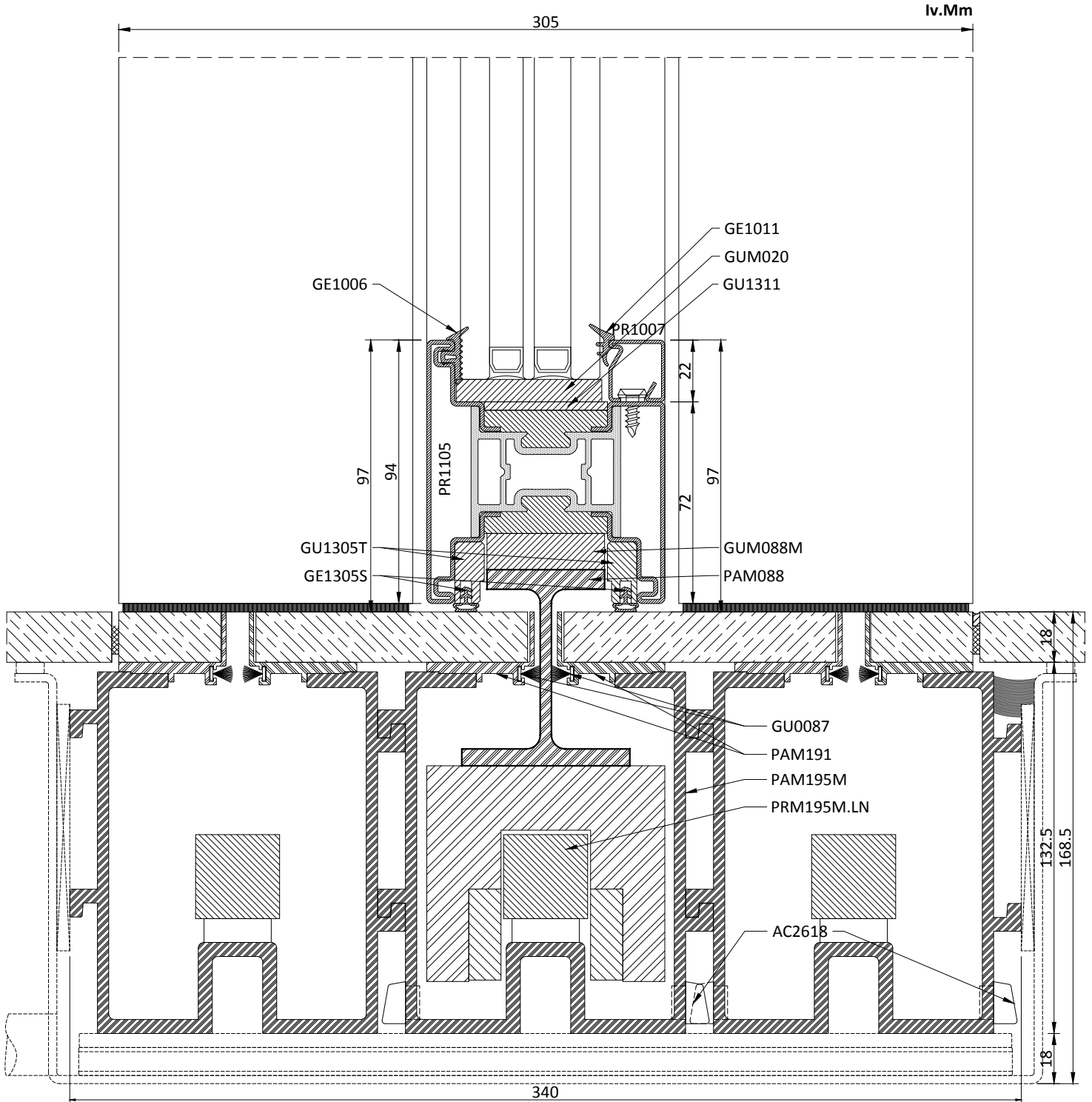
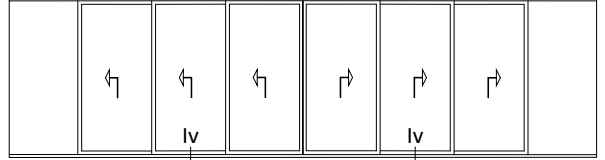

Schema | Type S1

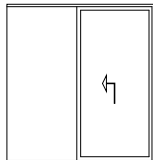

Schema | Type S2

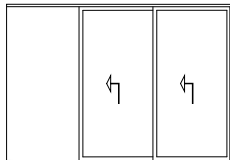

Schema | Type S3

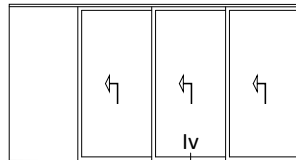

Schema | Type T1

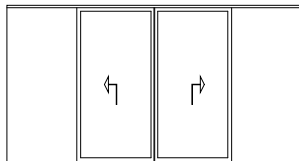

Schema | Type T2

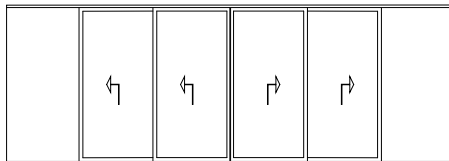

Schema | Type T3

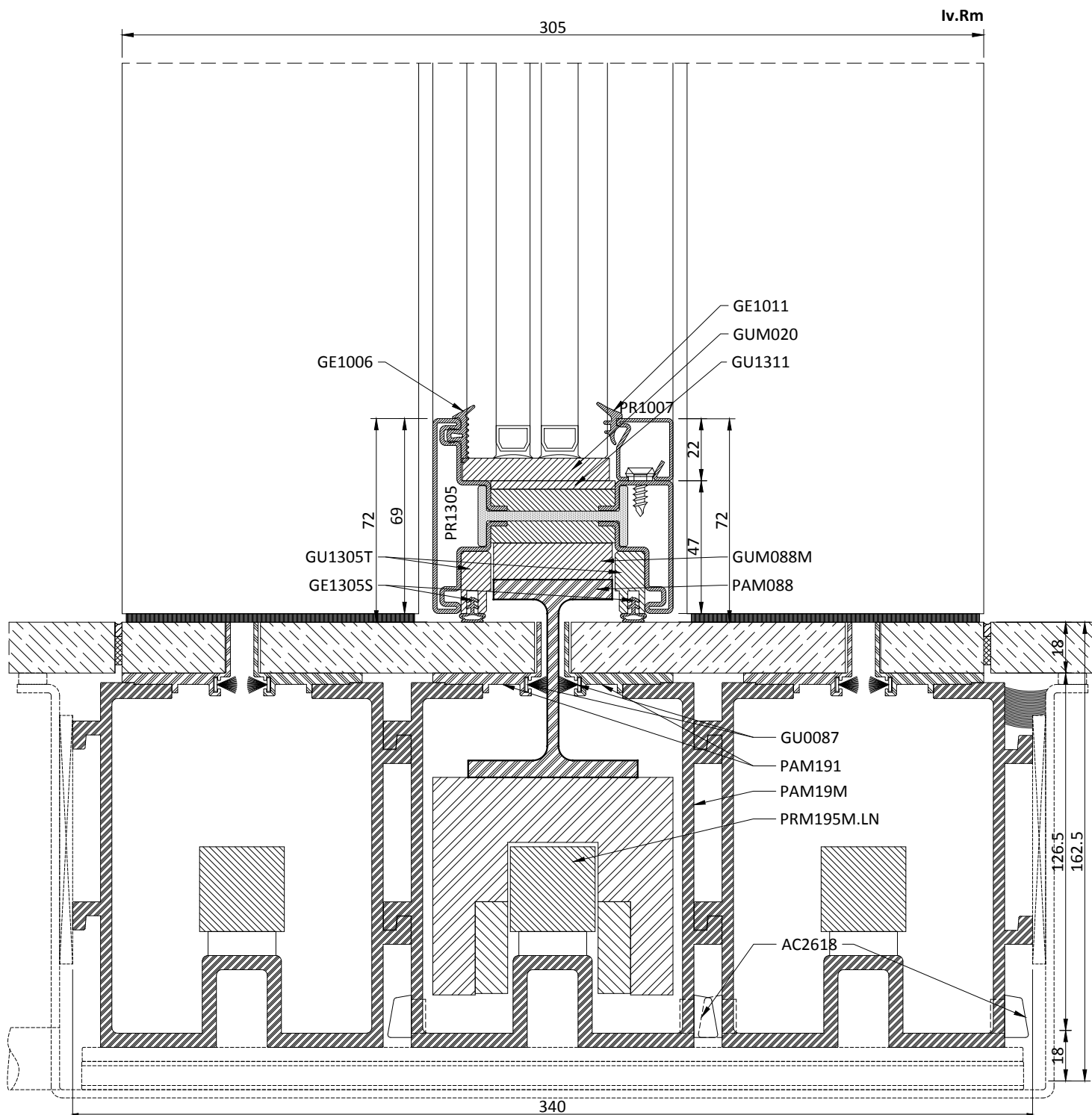
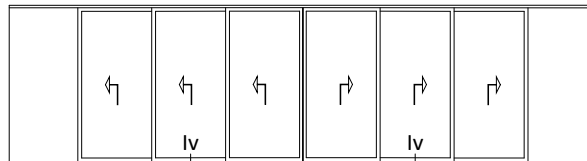

Schema | Type S1

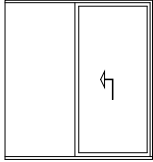

Schema | Type S2

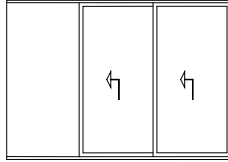

Schema | Type S3

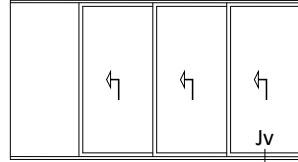

Schema | Type T1

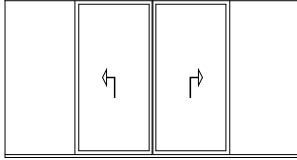

Schema | Type T2

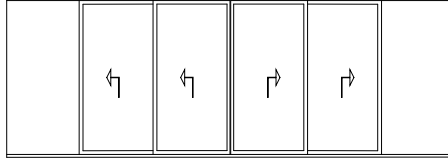

Schema | Type T3

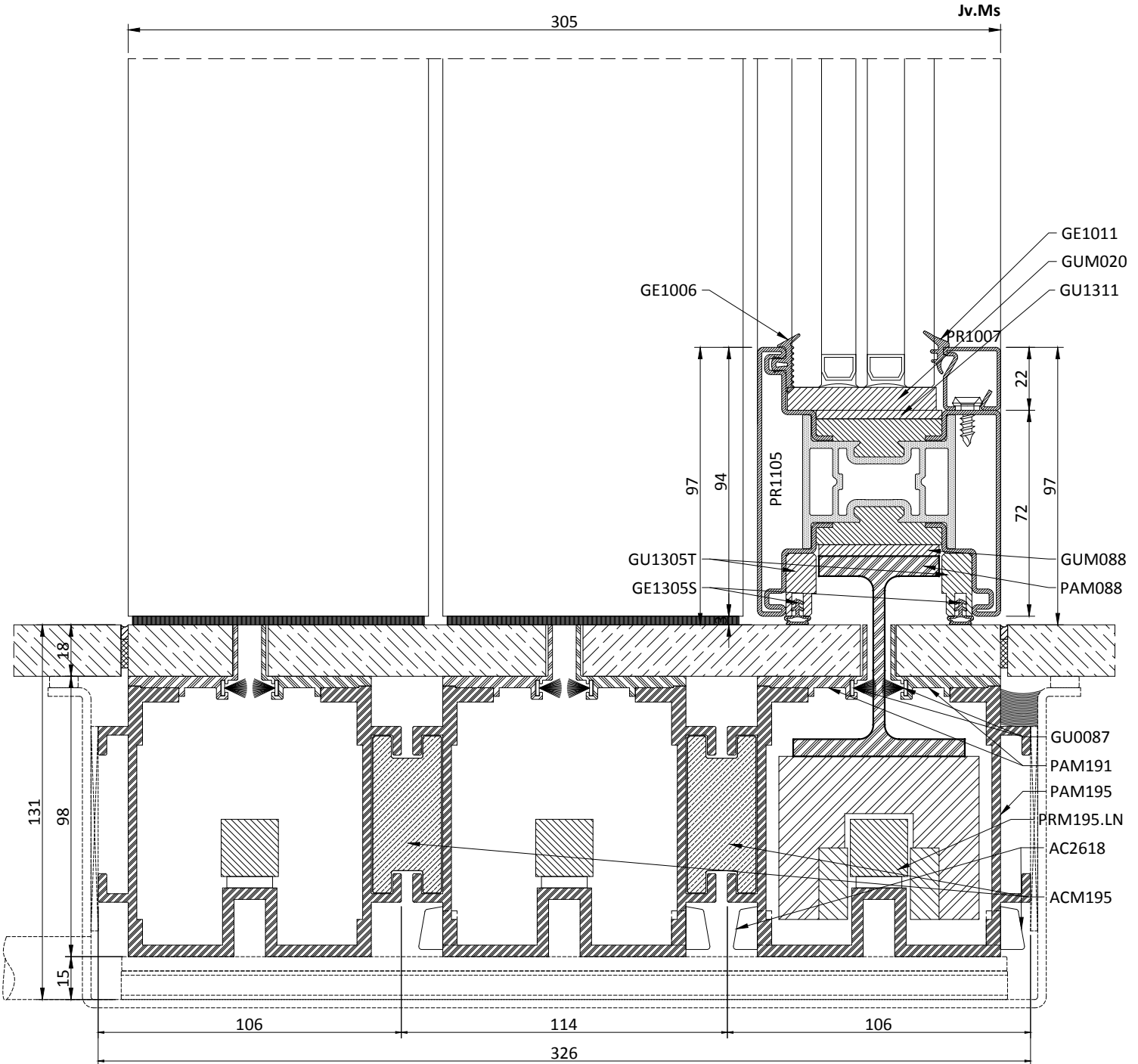
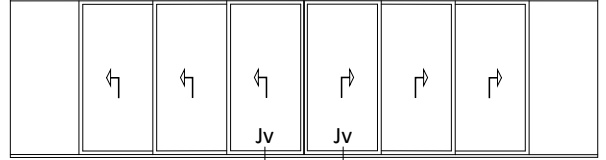

Schema | Type S1

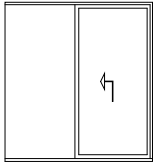

Schema | Type S2

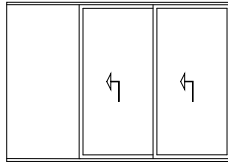

Schema | Type S3

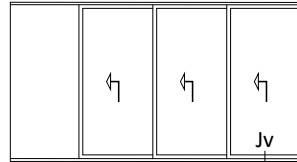

Schema | Type T1

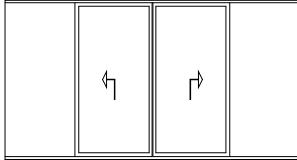

Schema | Type T2

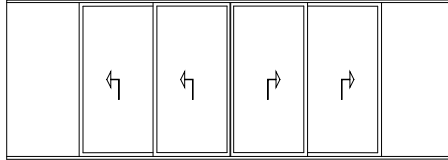

Schema | Type T3

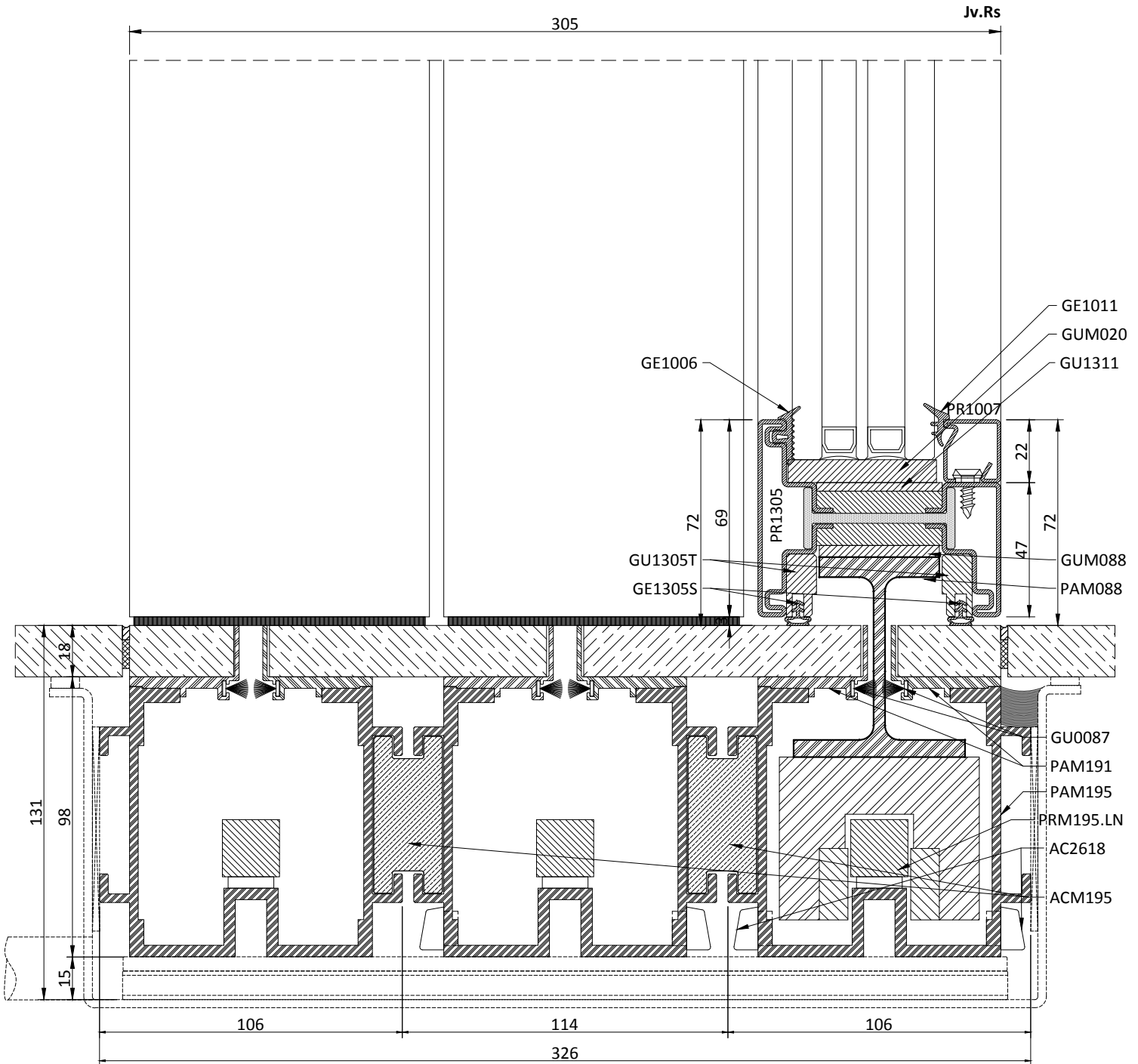
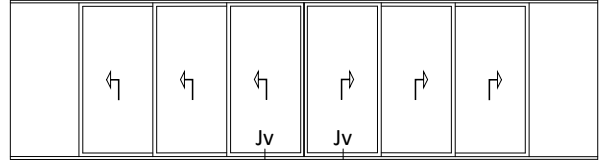



Schema | Type S1

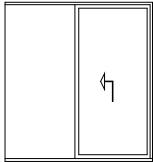

Schema | Type S2

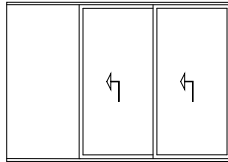

Schema | Type S3

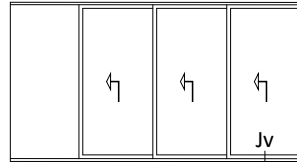

Schema | Type T1

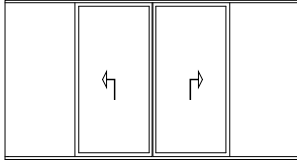

Schema | Type T2

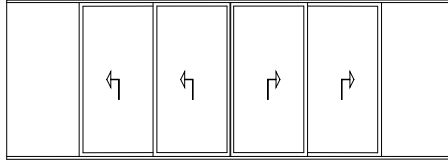

Schema | Type T3

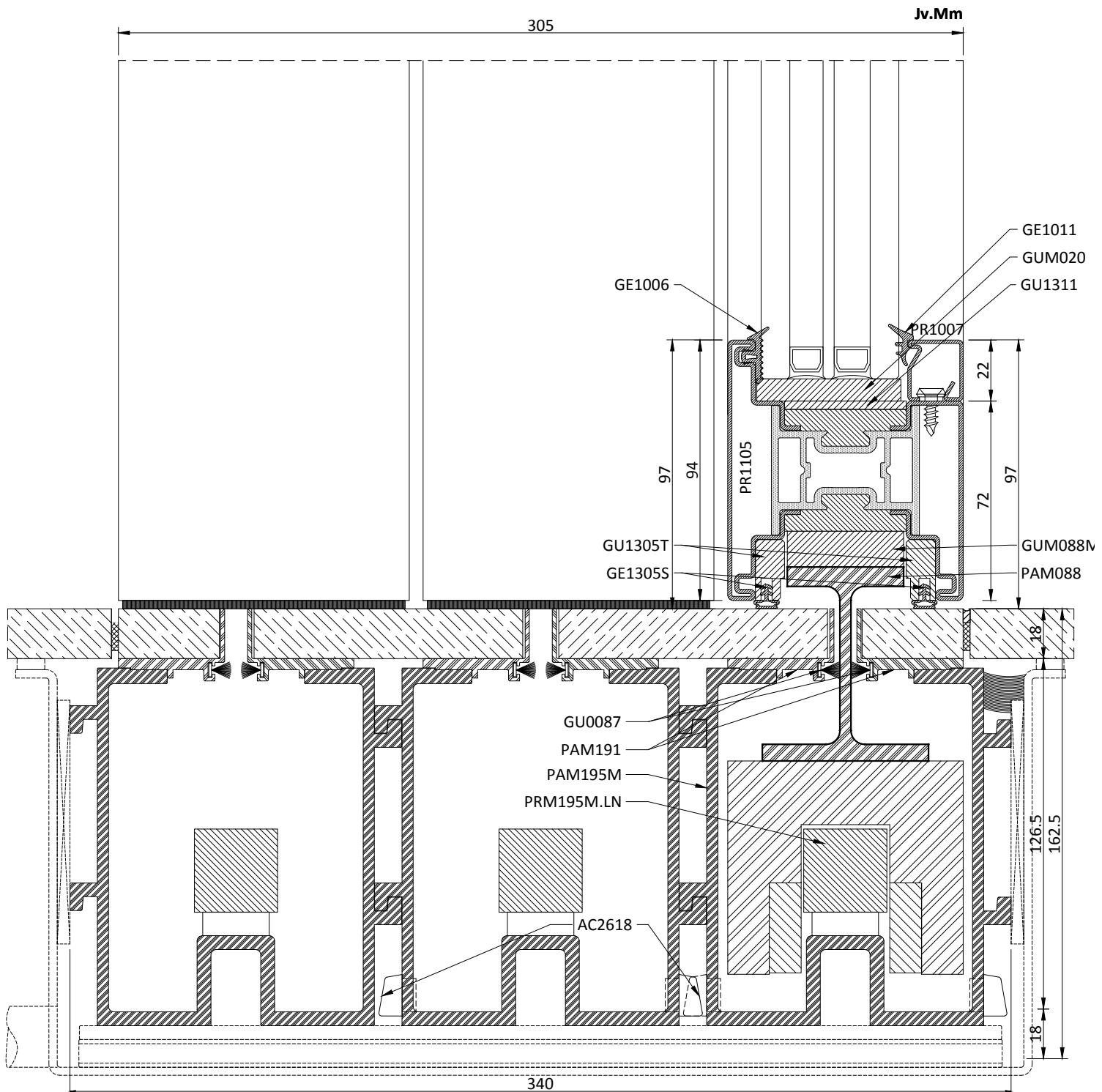
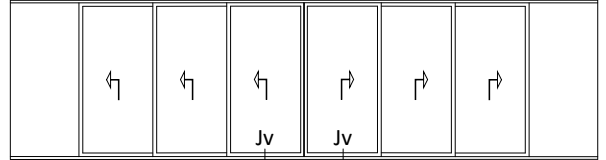

Schema | Type S1

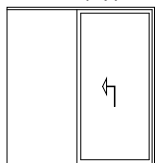

Schema | Type S2

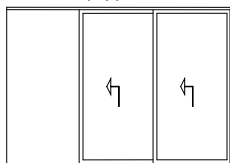

Schema | Type S3

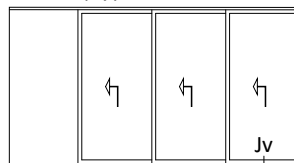

Schema | Type T1

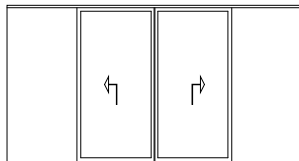

Schema | Type T2

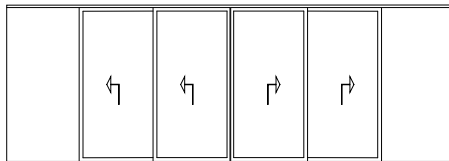

Schema | Type T3

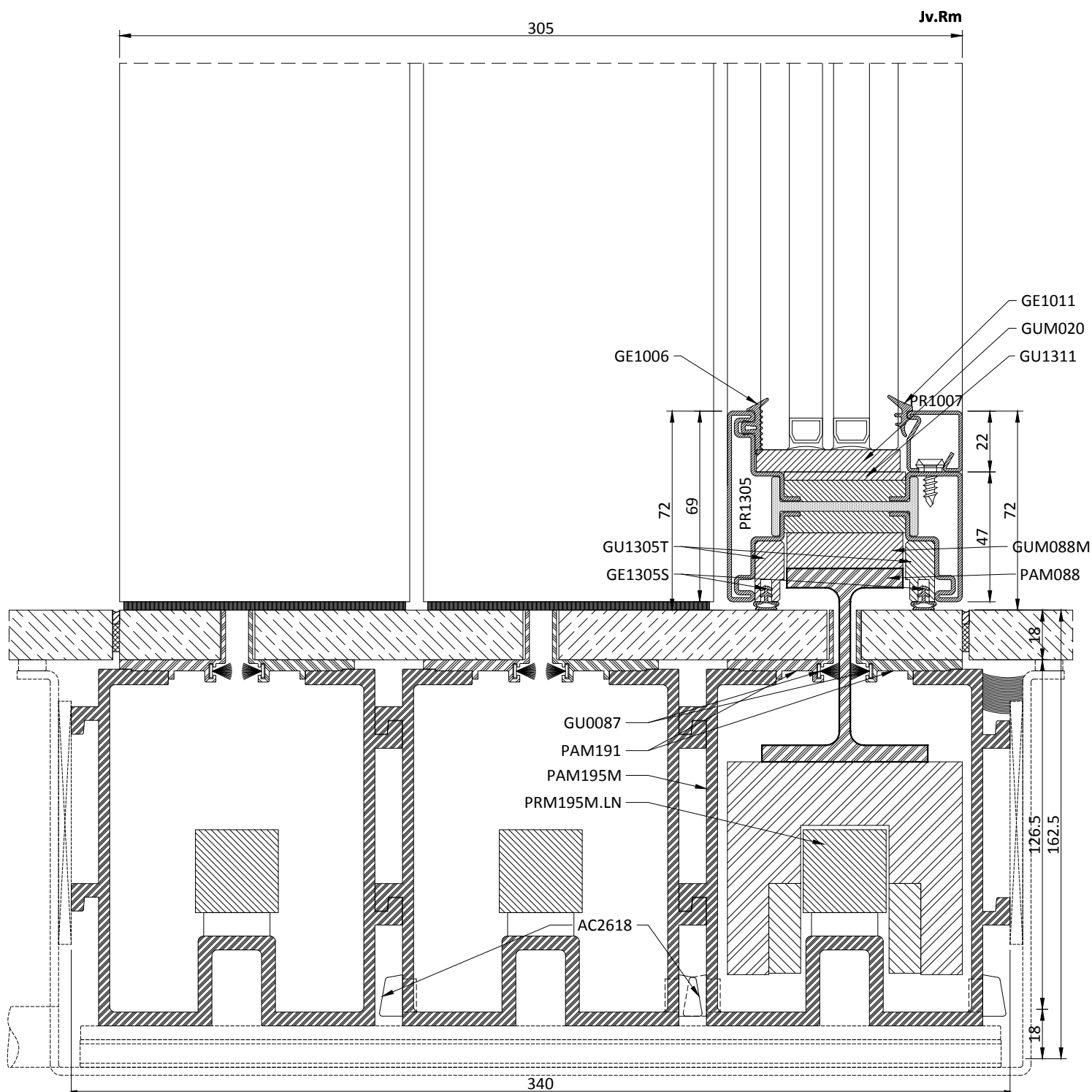
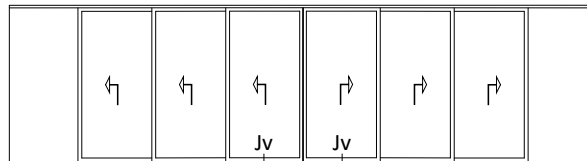

Schema | Type S1

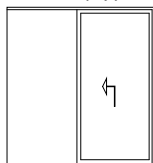

Schema | Type S2

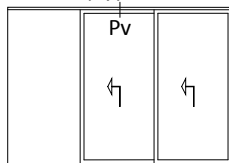

Schema | Type S3

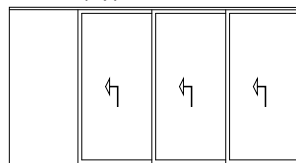

Schema | Type T1

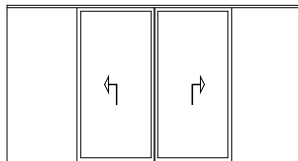

Schema | Type T2

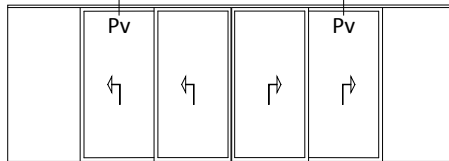

Schema | Type T3

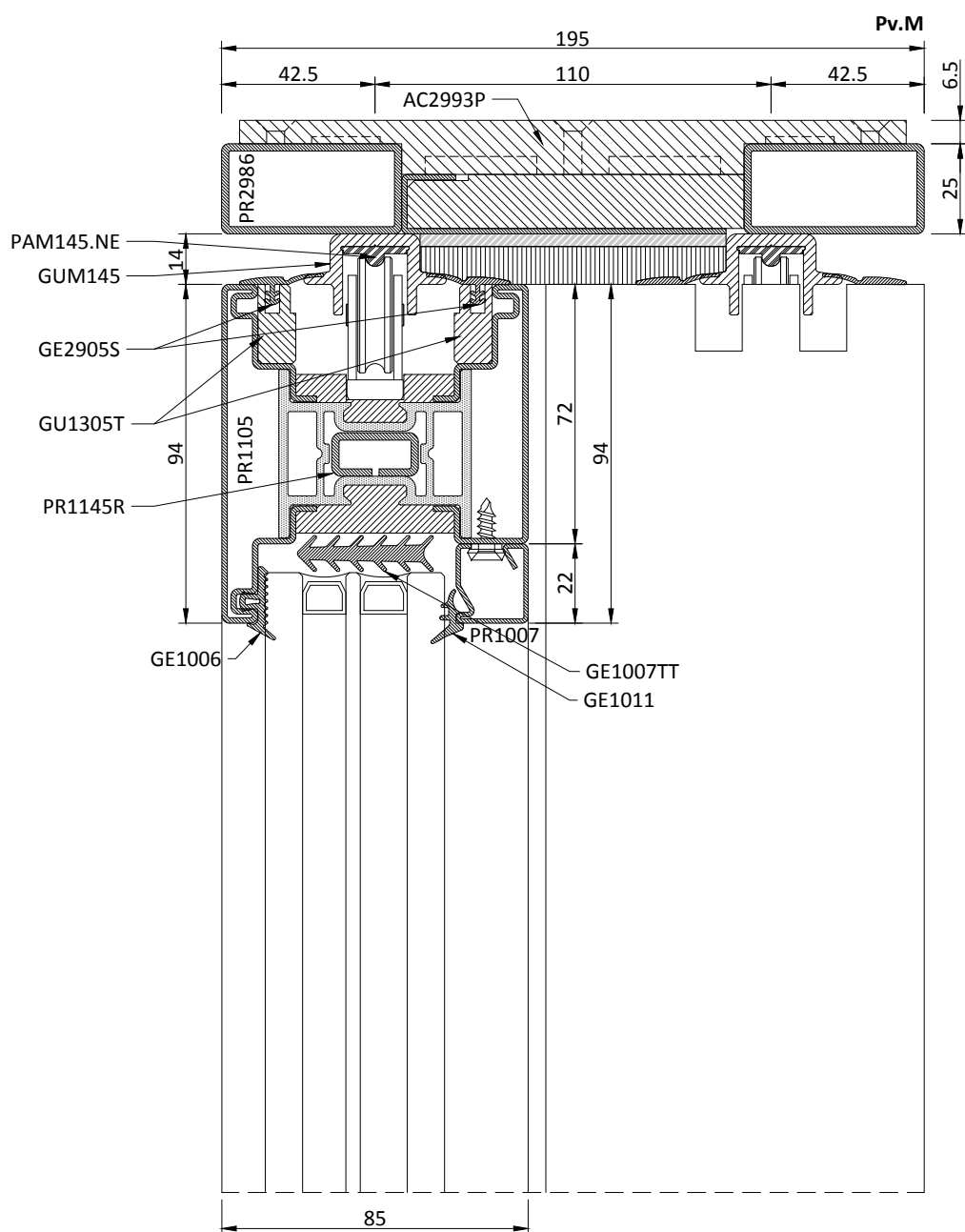
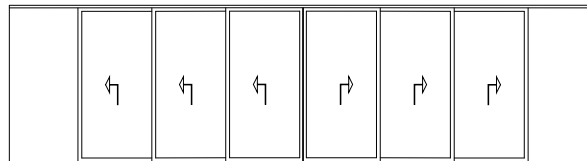

Schema | Type S1

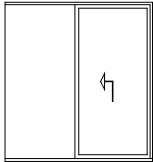

Schema | Type S2

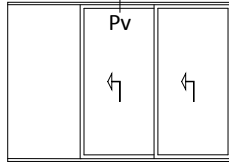

Schema | Type S3

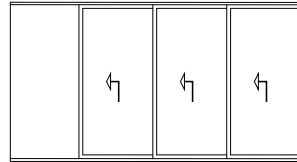

Schema | Type T1

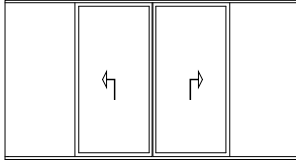

Schema | Type T2

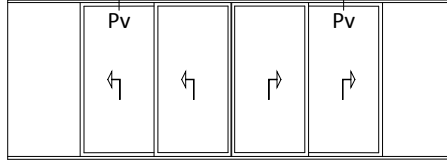

Schema | Type T3

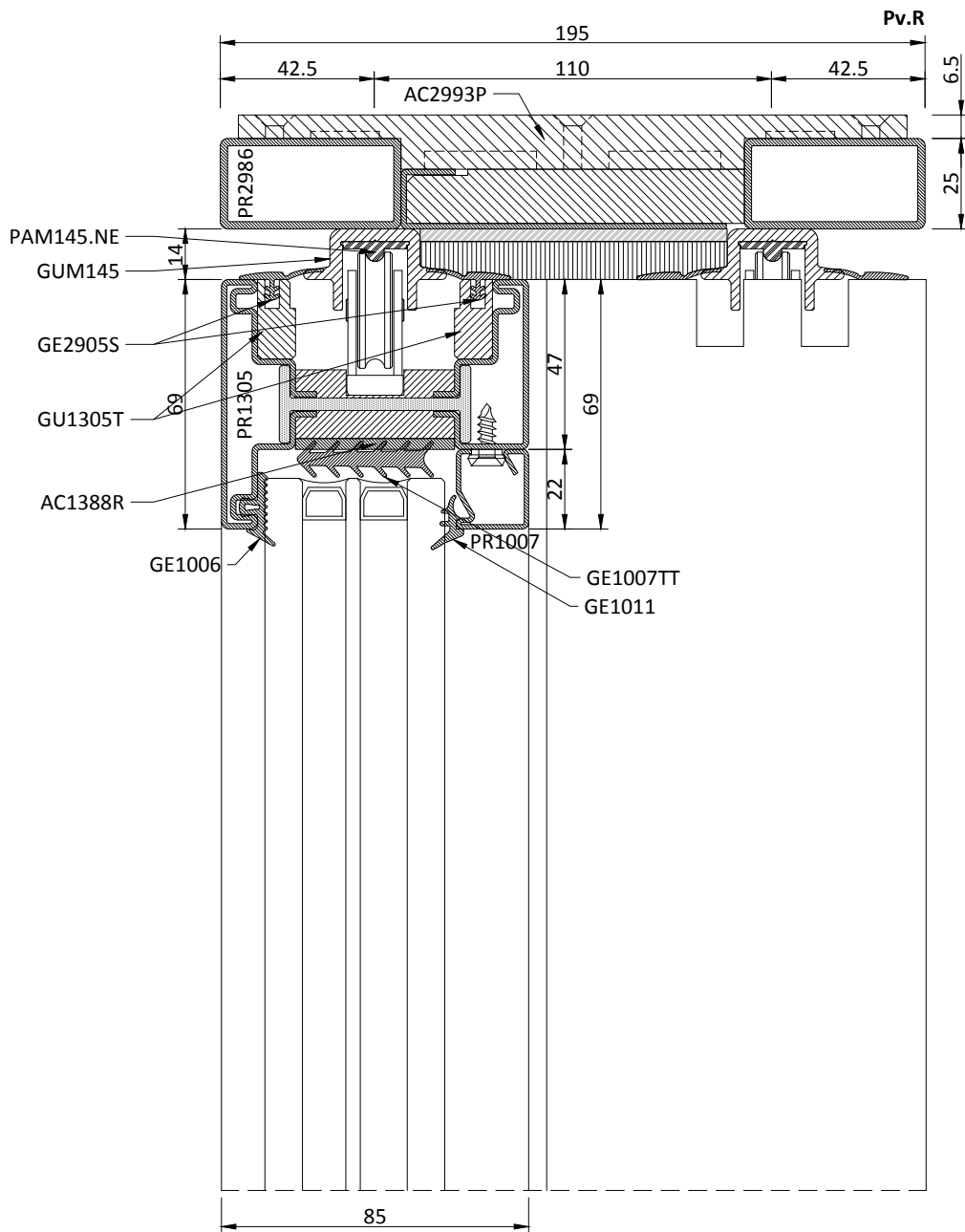
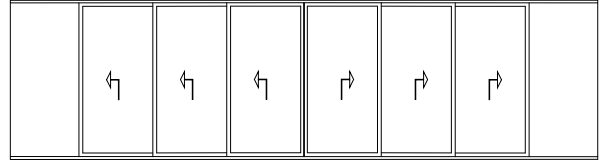

Schema | Type S1

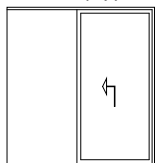

Schema | Type S2

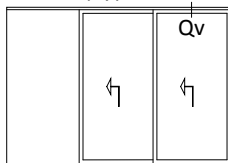

Schema | Type S3

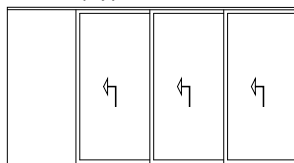

Schema | Type T1

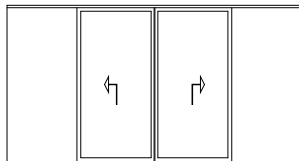

Schema | Type T2

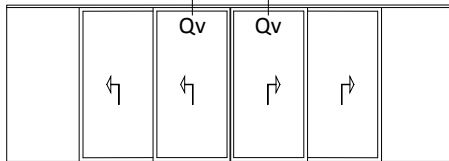

Schema | Type T3

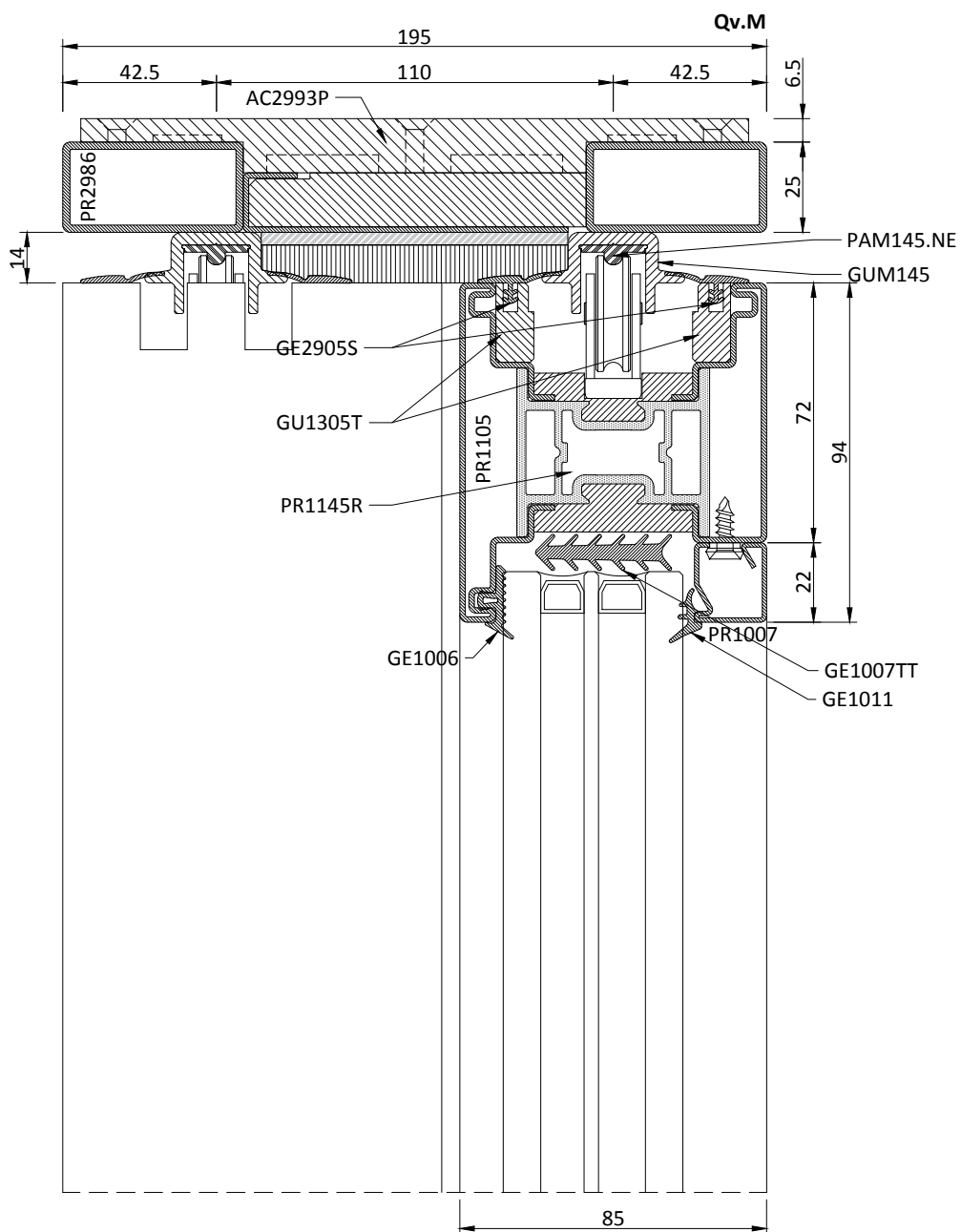
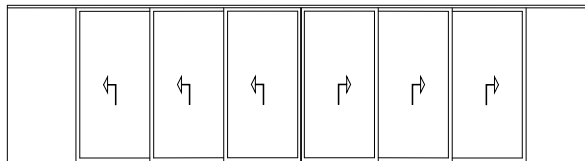

Schema | Type S1

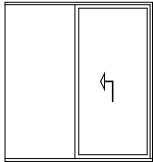

Schema | Type S2

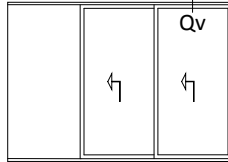

Schema | Type S3

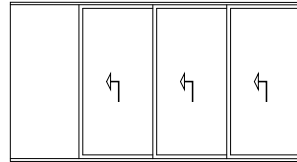

Schema | Type T1

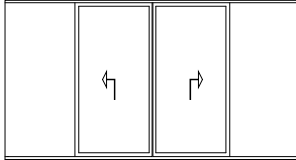

Schema | Type T2

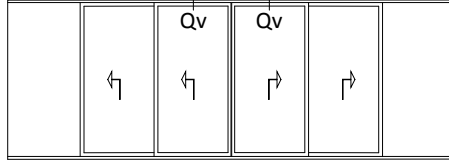

Schema | Type T3

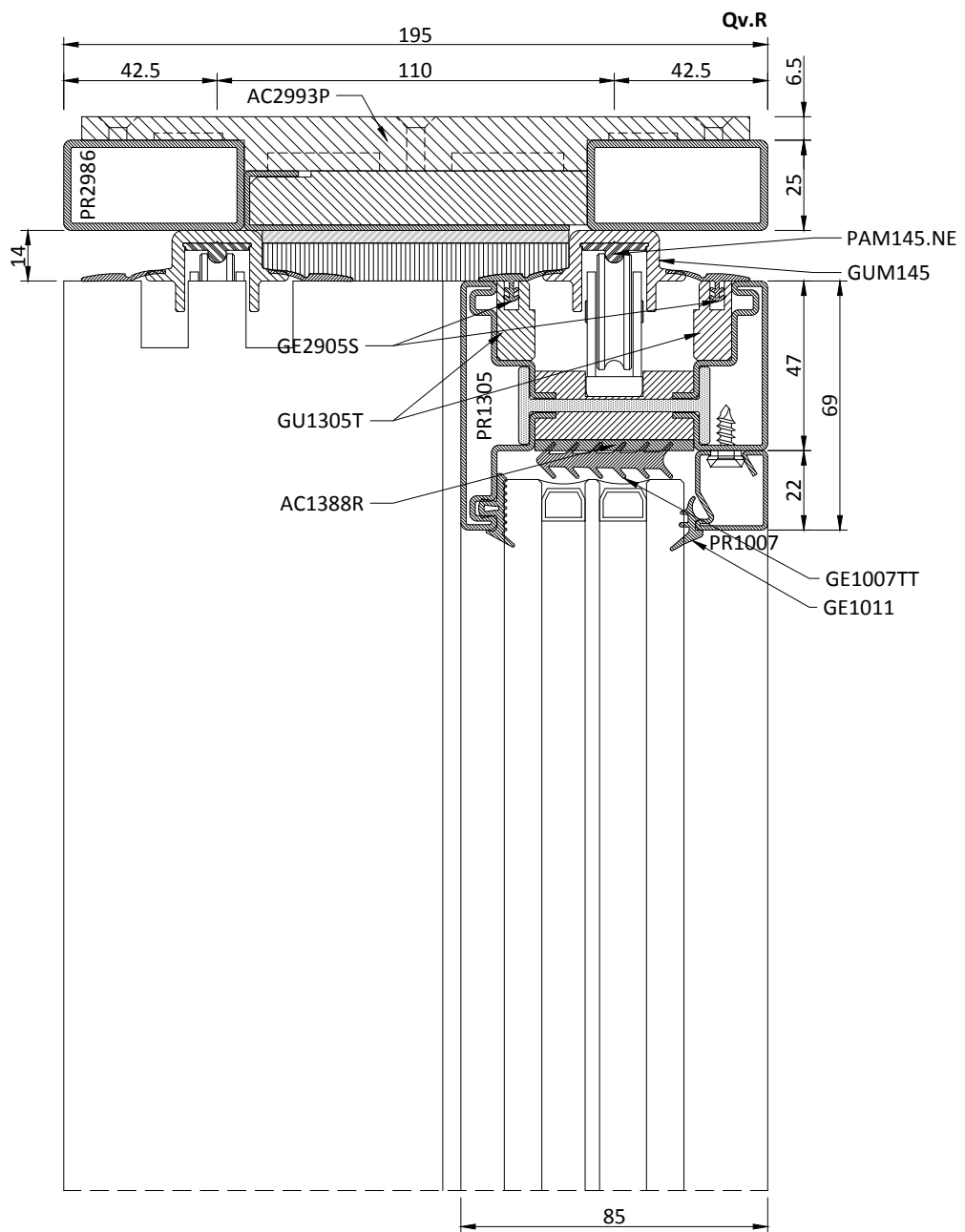
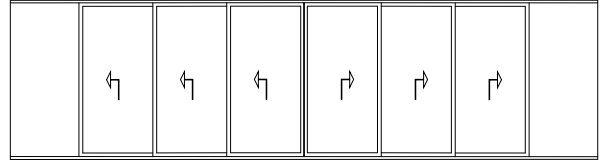

Schema | Type S1

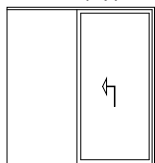

Schema | Type S2

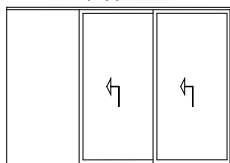

Schema | Type S3

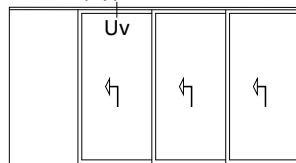

Schema | Type T1

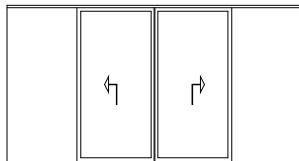

Schema | Type T2

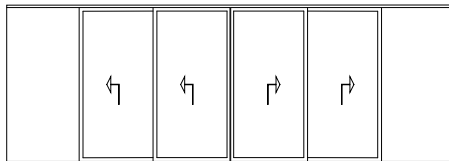

Schema | Type T3

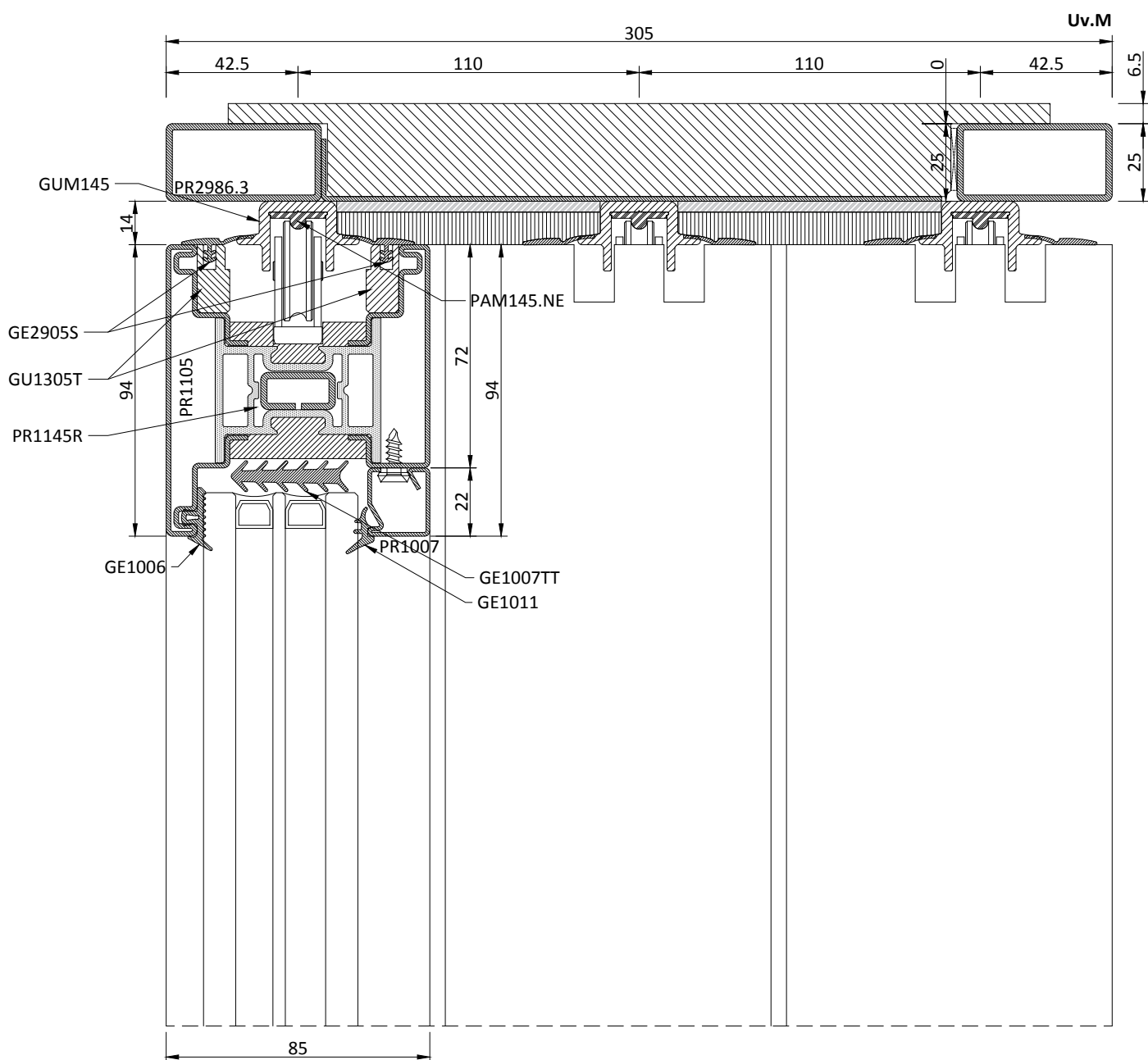
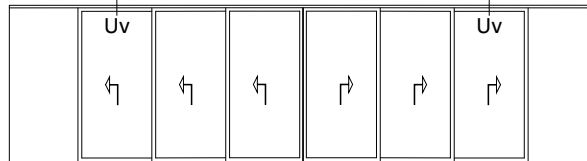

Schema | Type S1

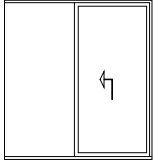

Schema | Type S2

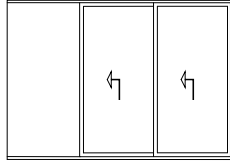

Schema | Type S3

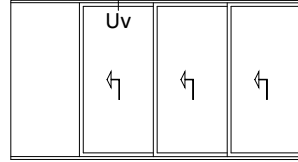

Schema | Type T1

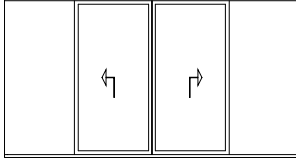

Schema | Type T2

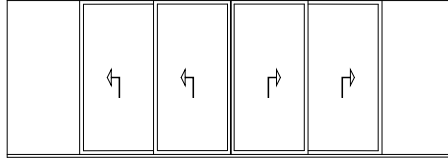

Schema | Type T3

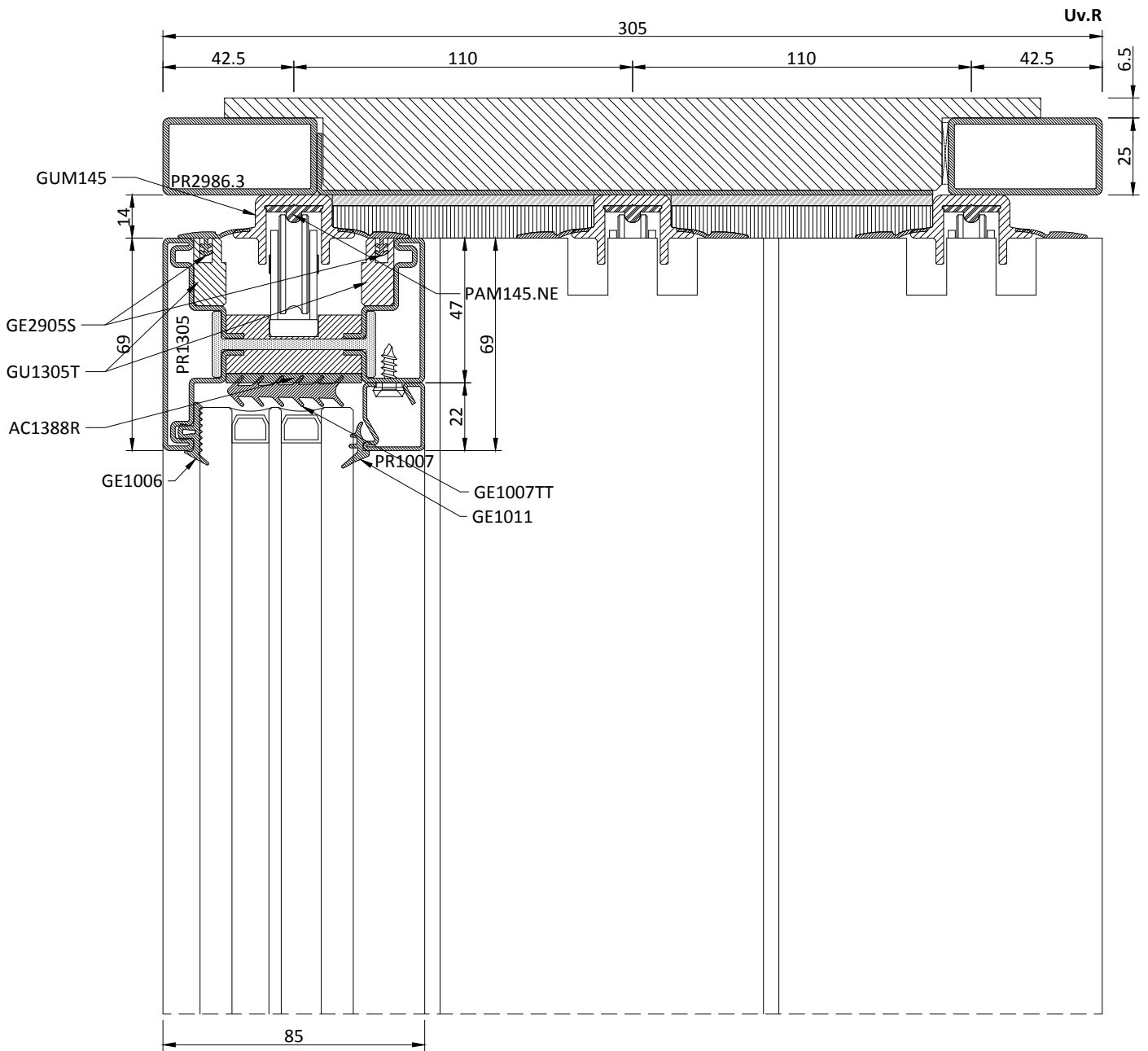
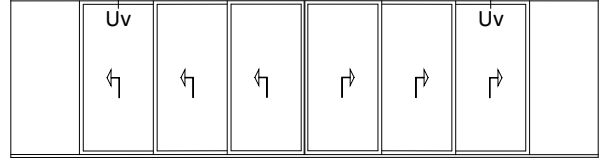



Schema | Type S1

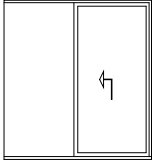

Schema | Type S2

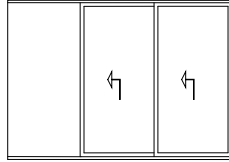

Schema | Type S3

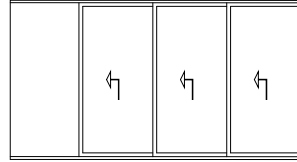

Schema | Type T1

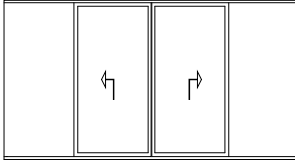

Schema | Type T2

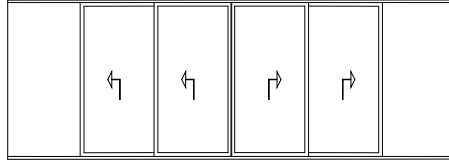

Schema | Type T3

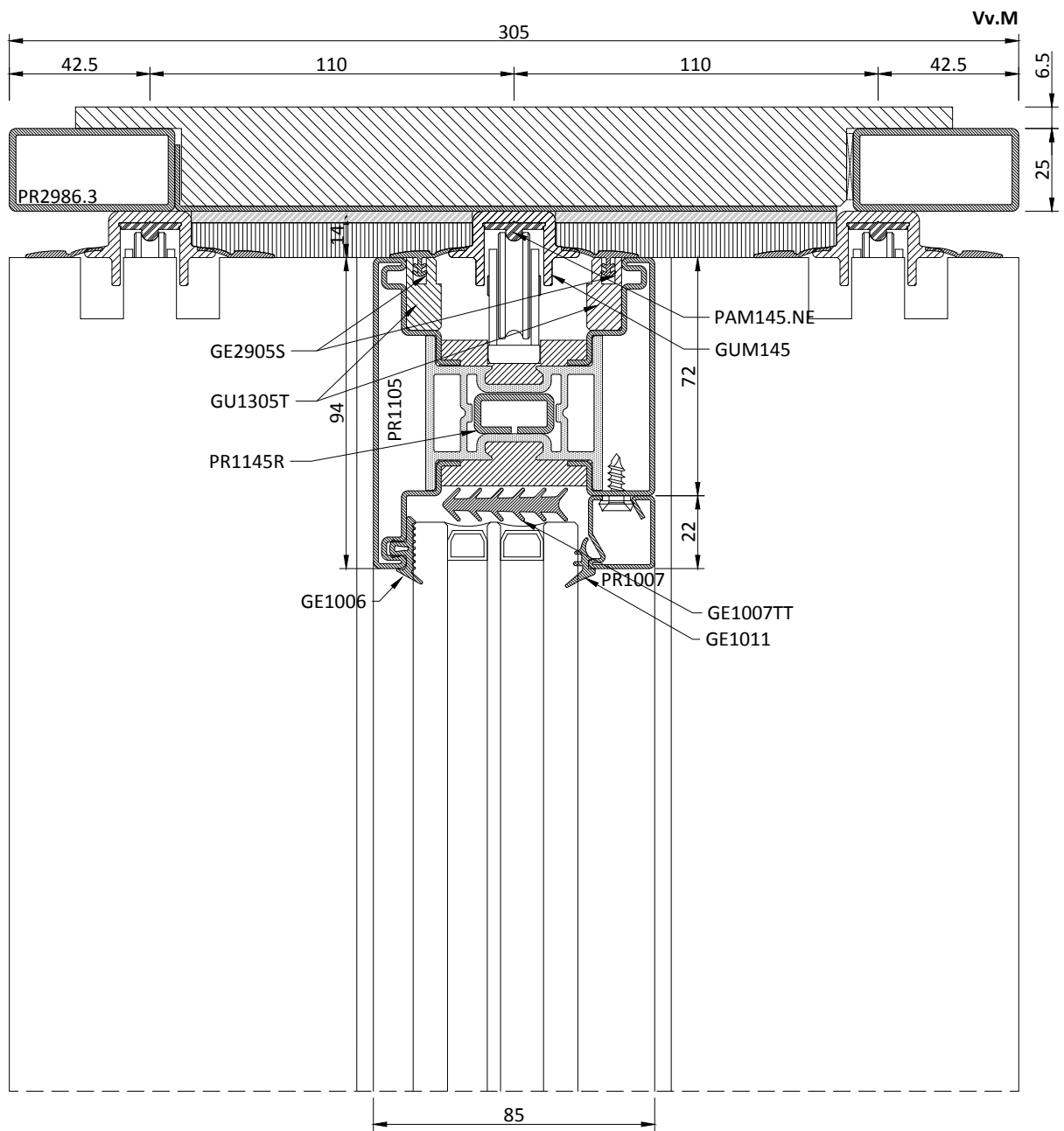
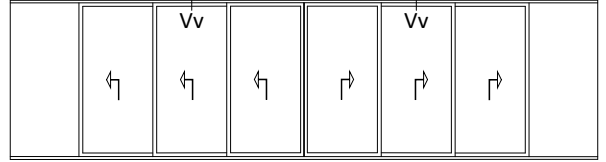

Schema | Type S1

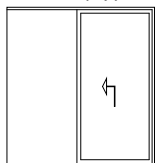

Schema | Type S2

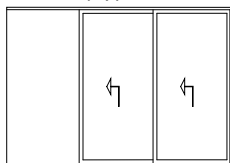

Schema | Type S3

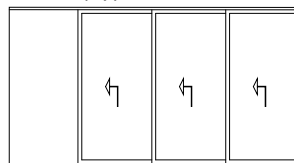

Schema | Type T1

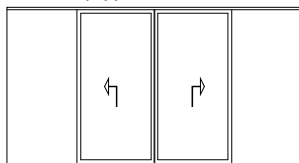

Schema | Type T2

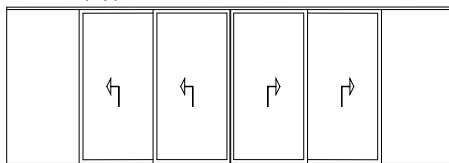

Schema | Type T3

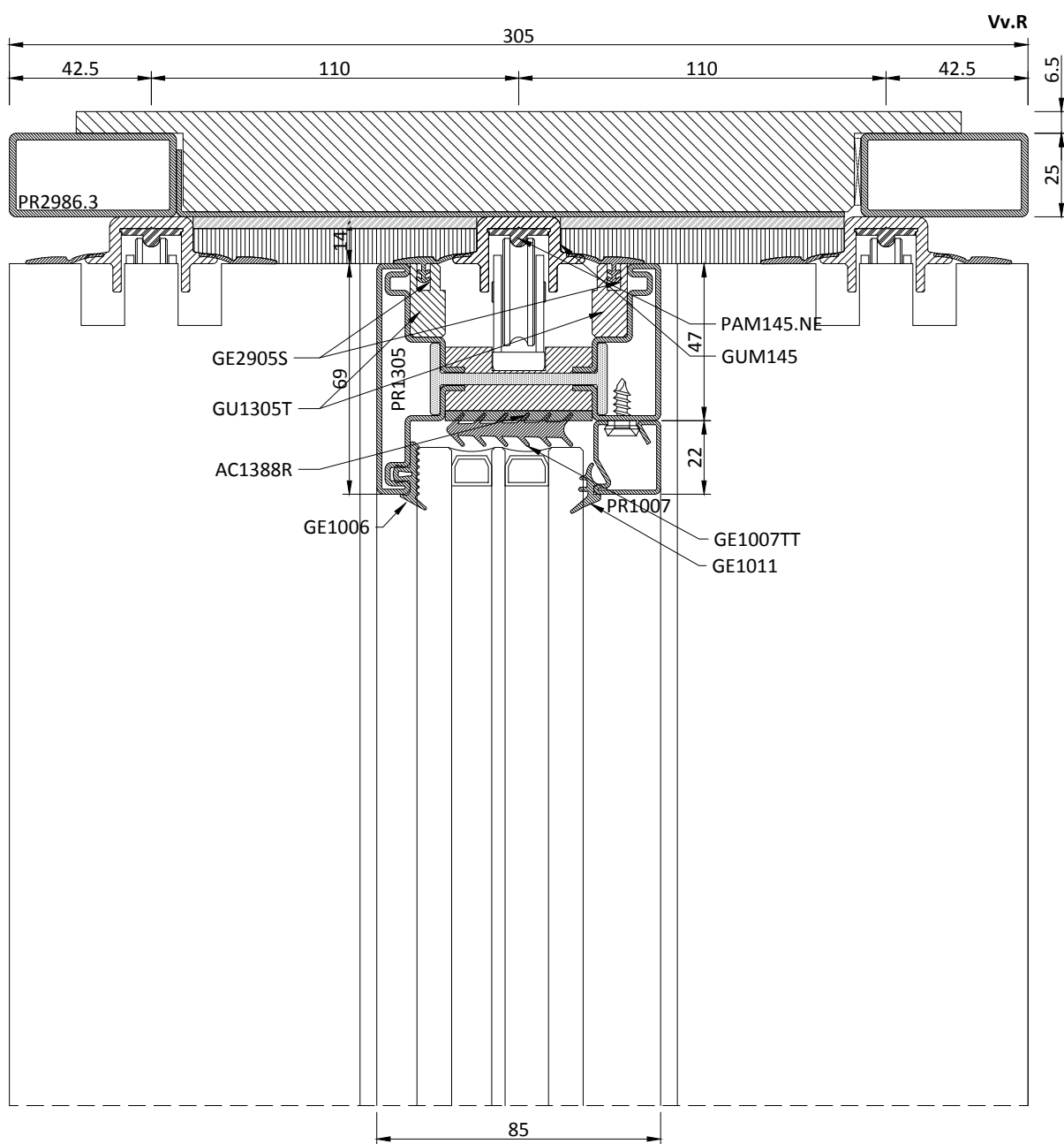
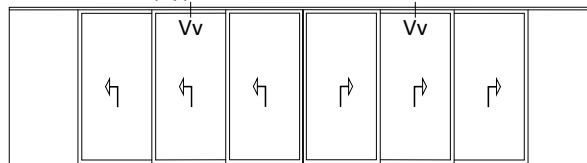

Schema | Type S1

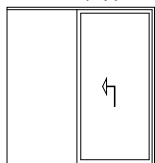

Schema | Type S2

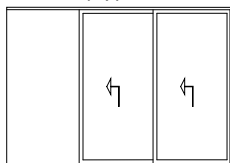

Schema | Type S3

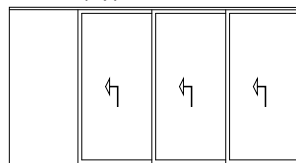

Schema | Type T1

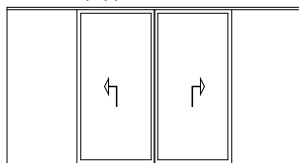

Schema | Type T2

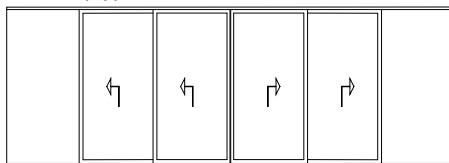

Schema | Type T3

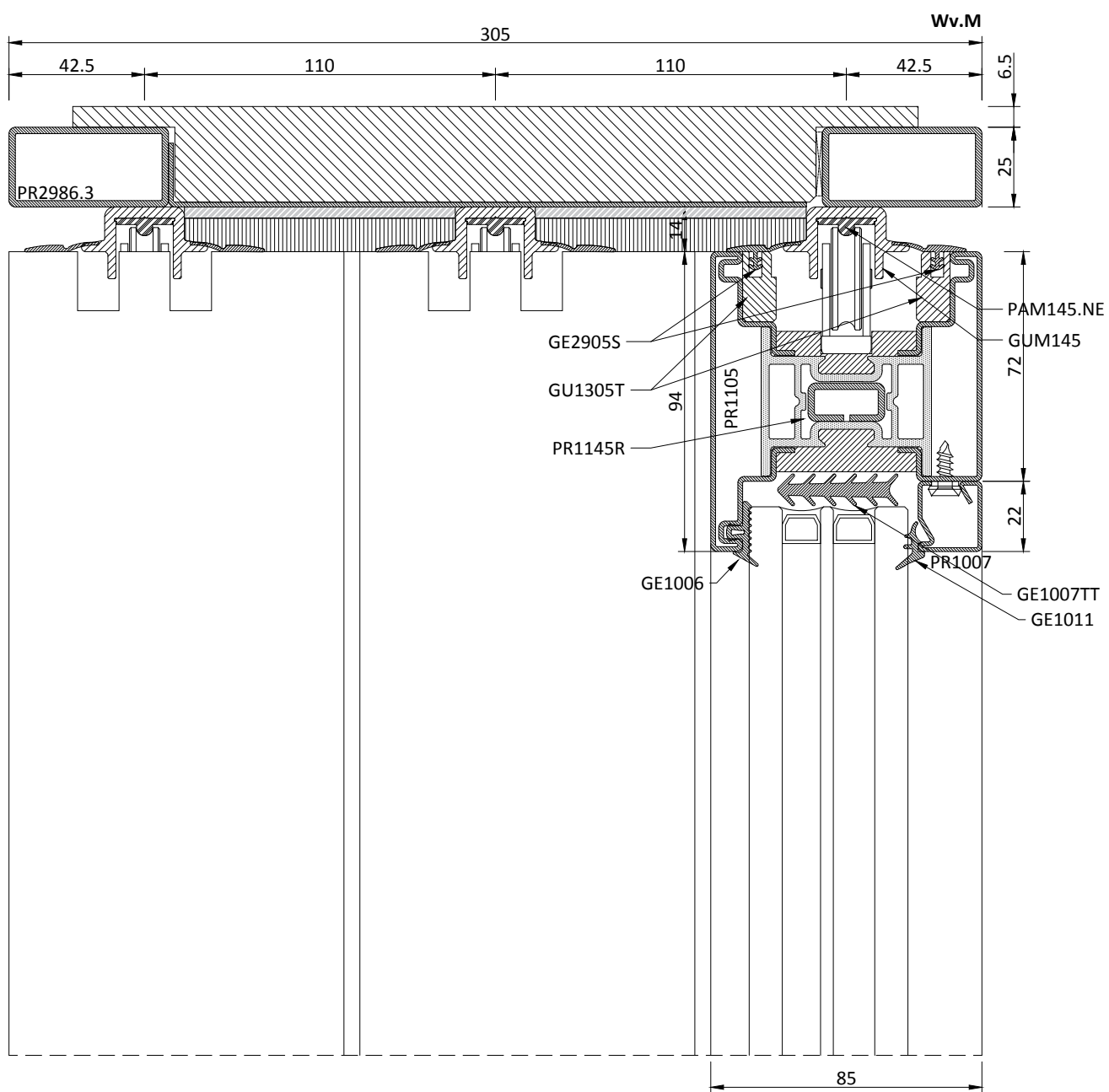
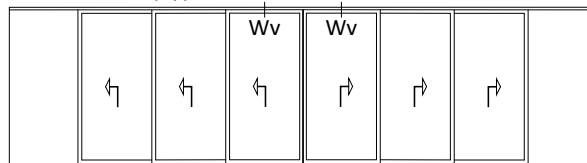

Schema | Type S1

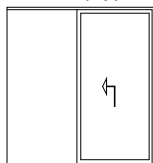

Schema | Type S2

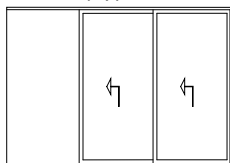

Schema | Type S3

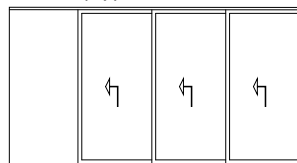

Schema | Type T1

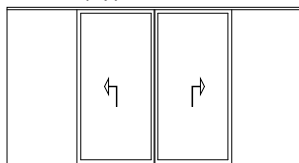

Schema | Type T2

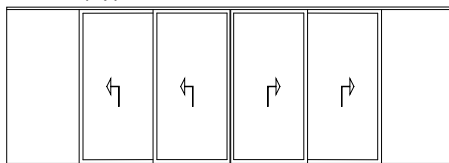

Schema | Type T3

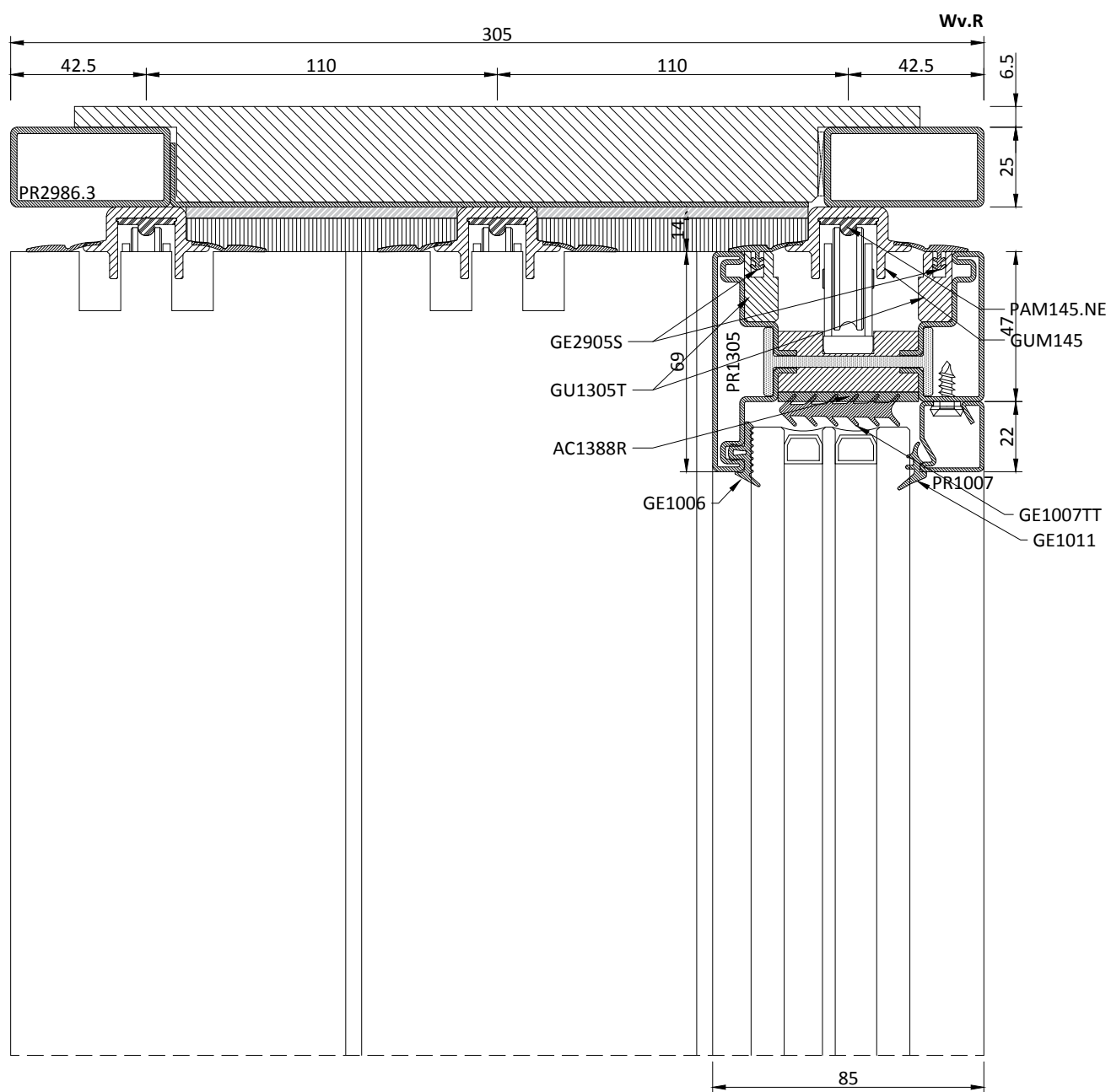
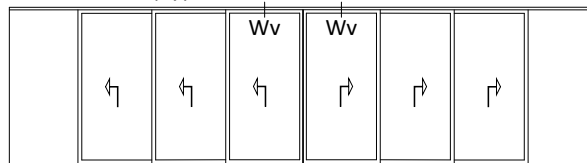

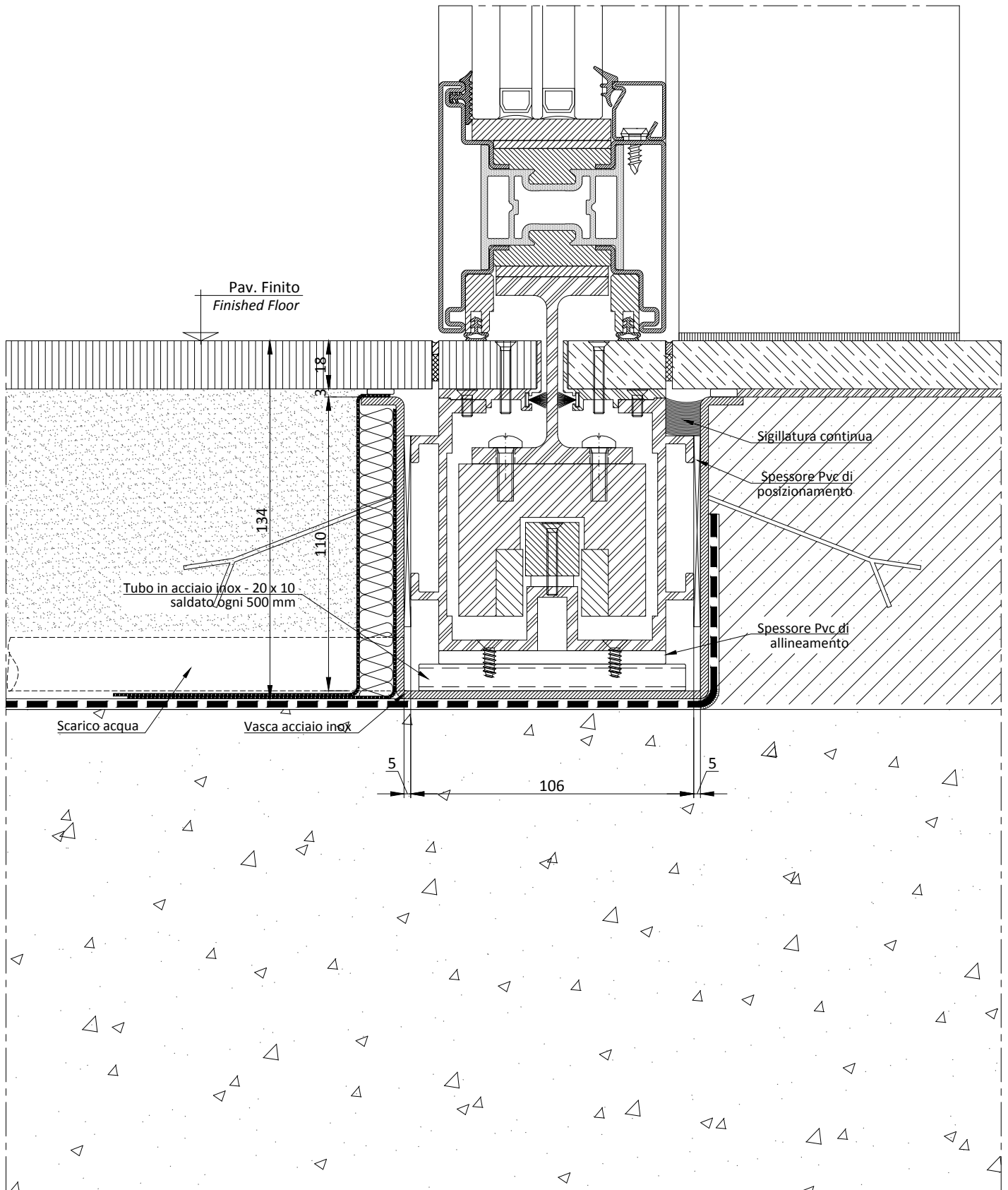
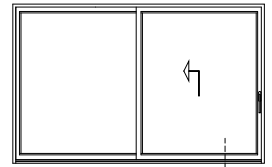

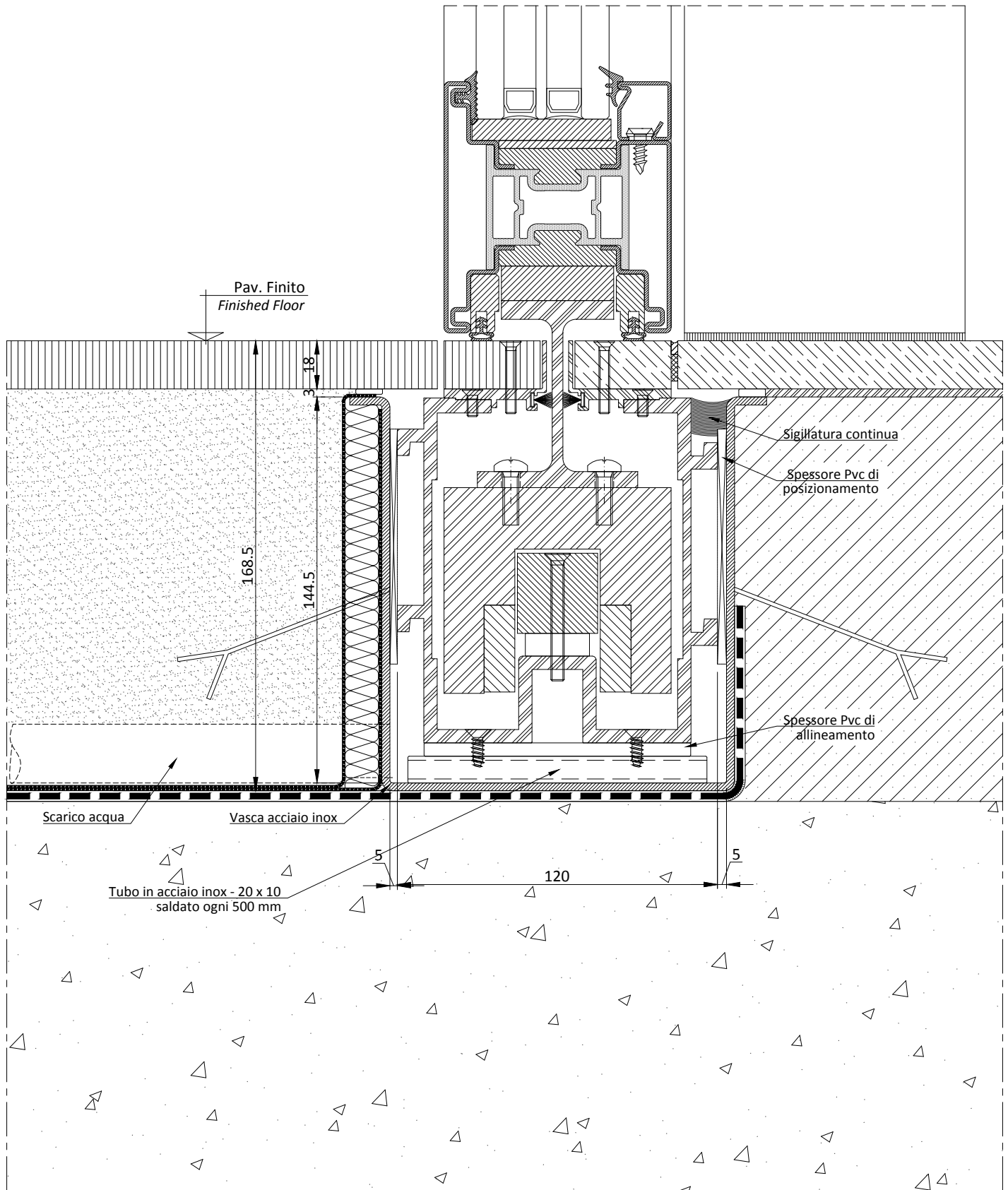
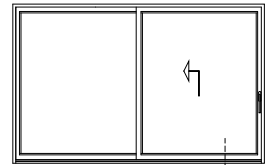

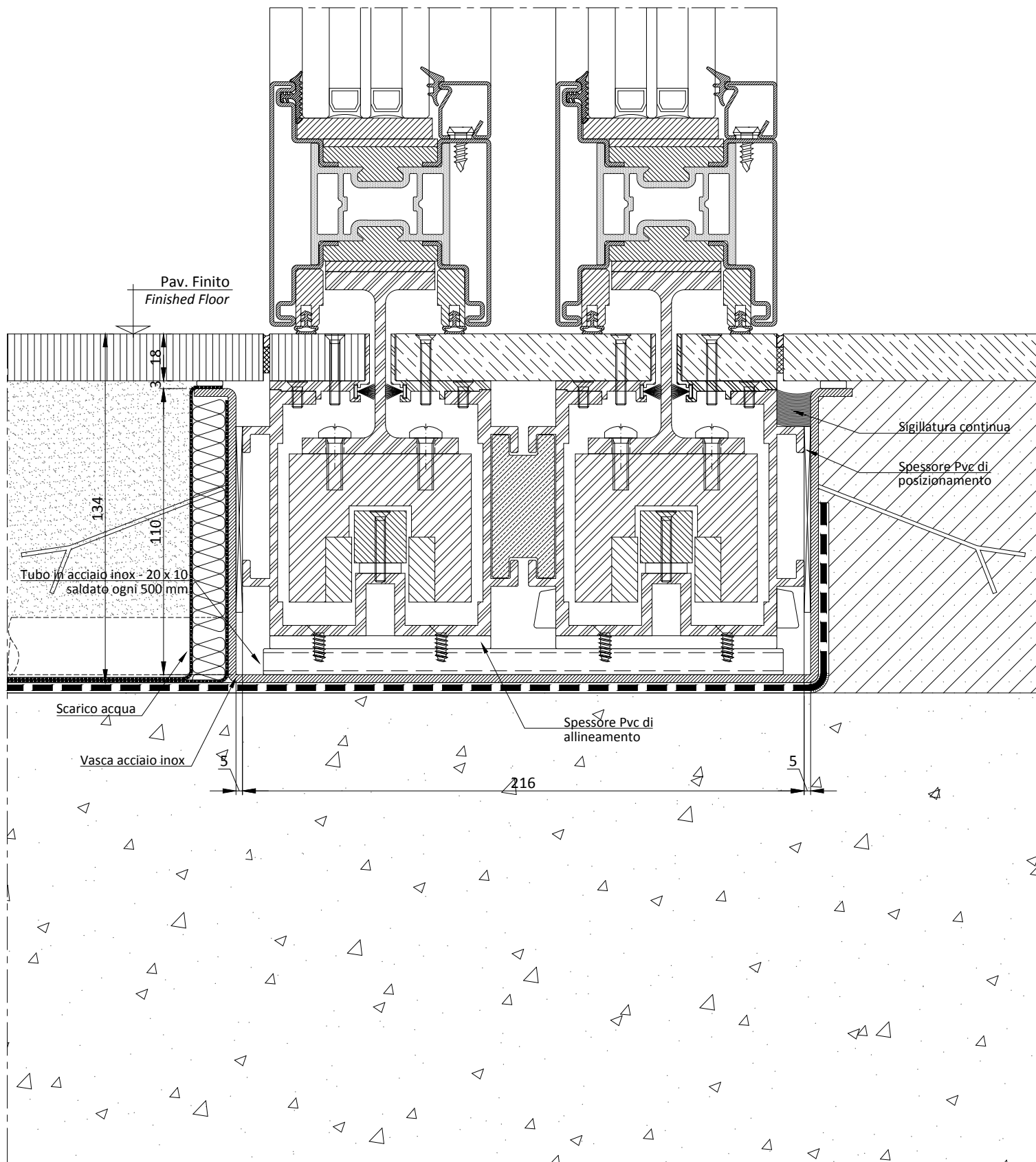
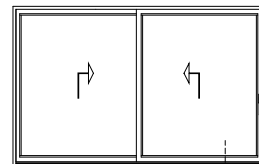

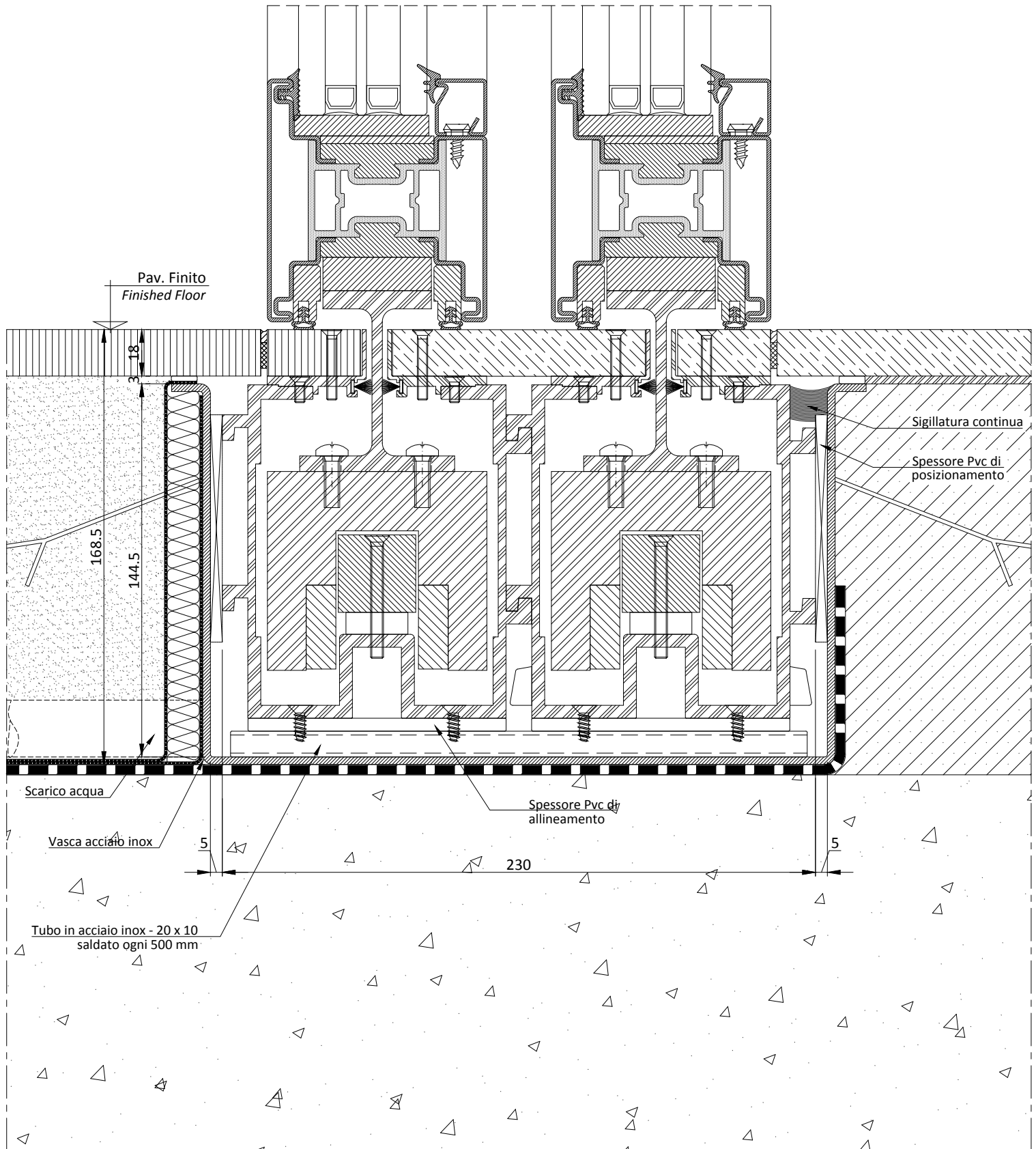
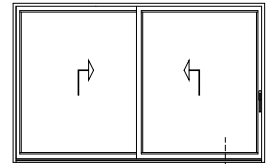



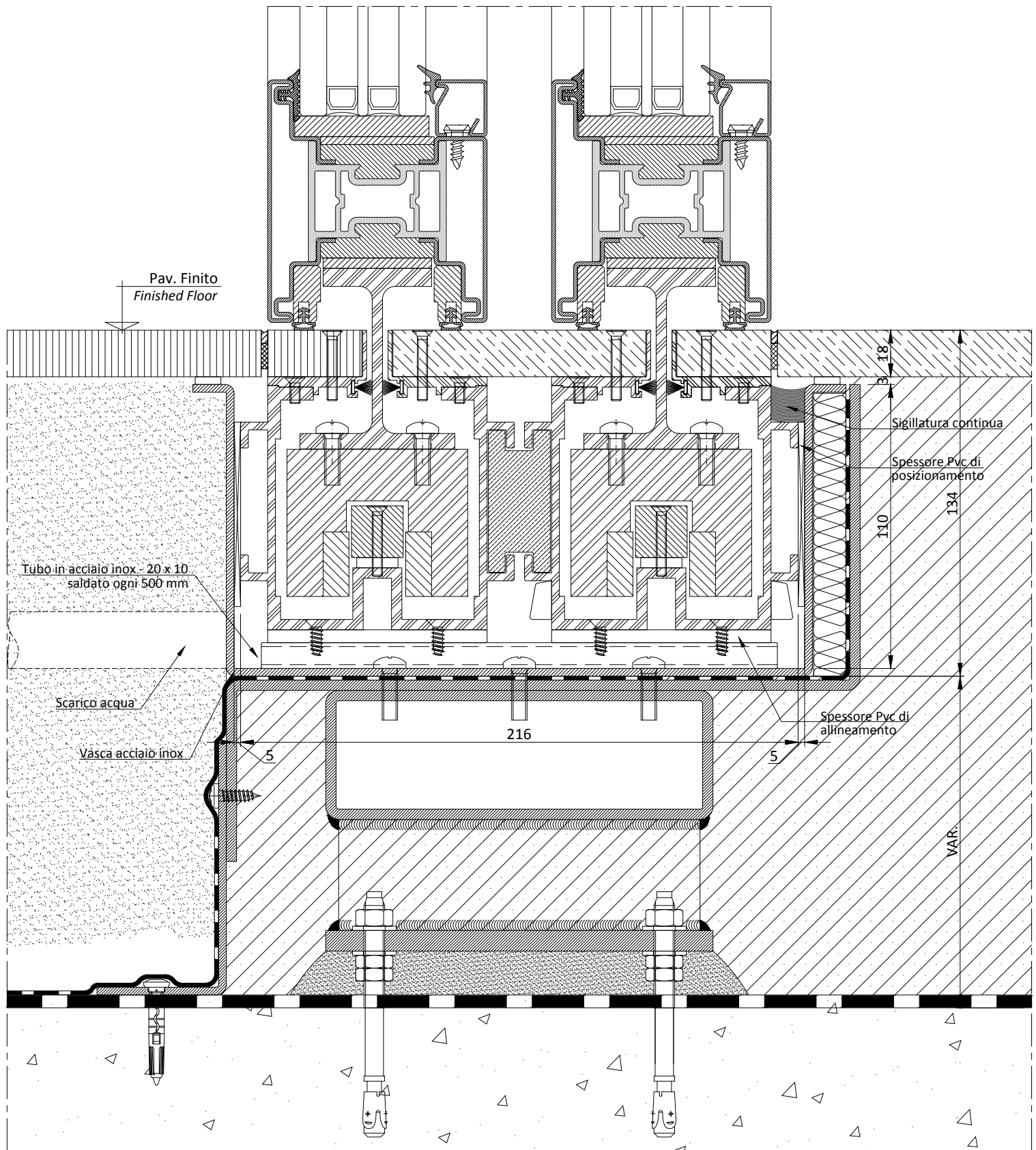
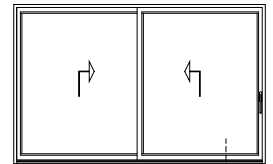

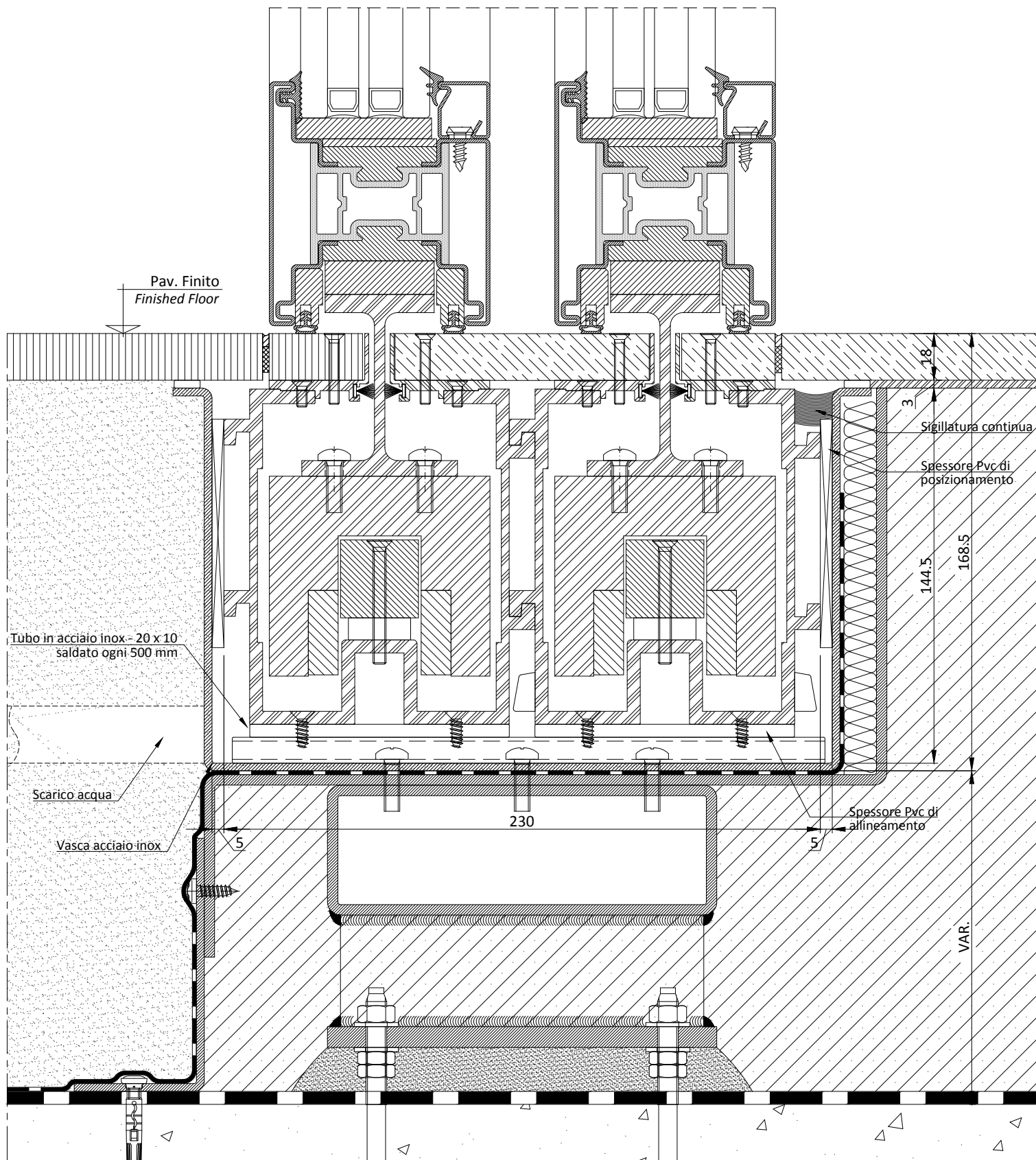
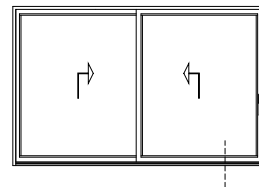

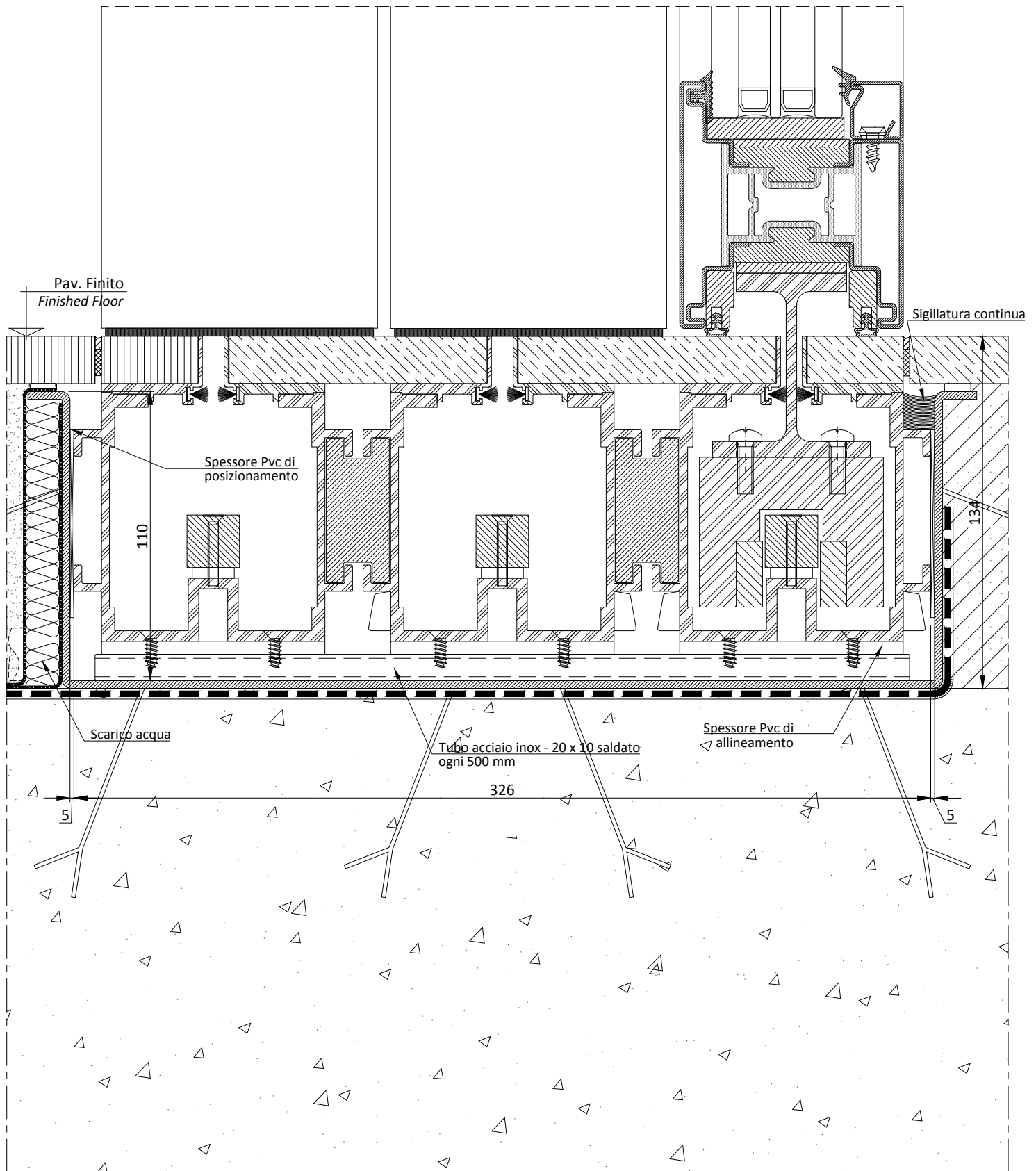
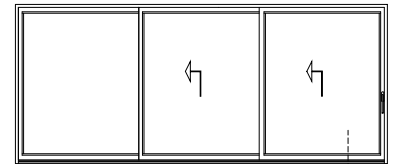

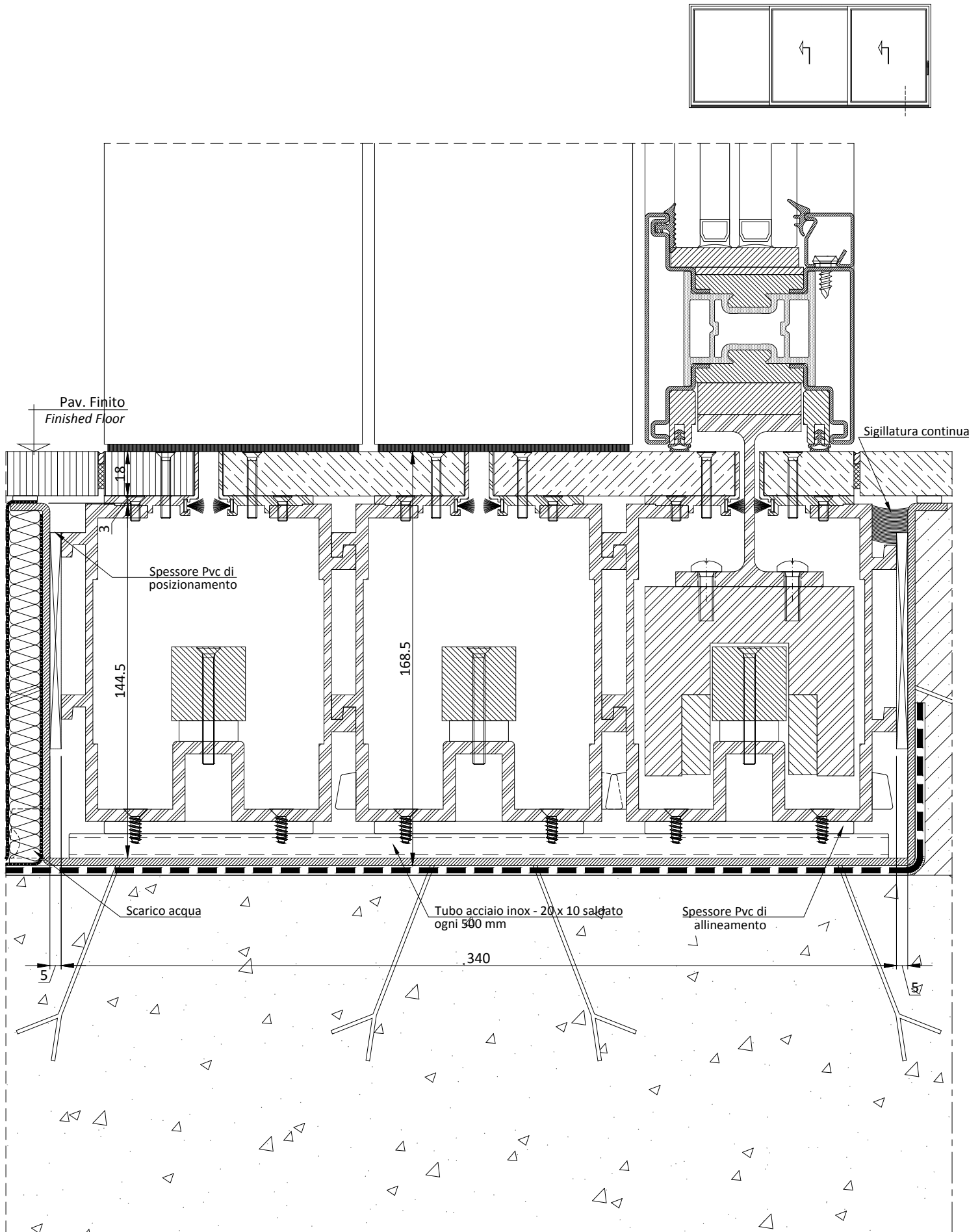

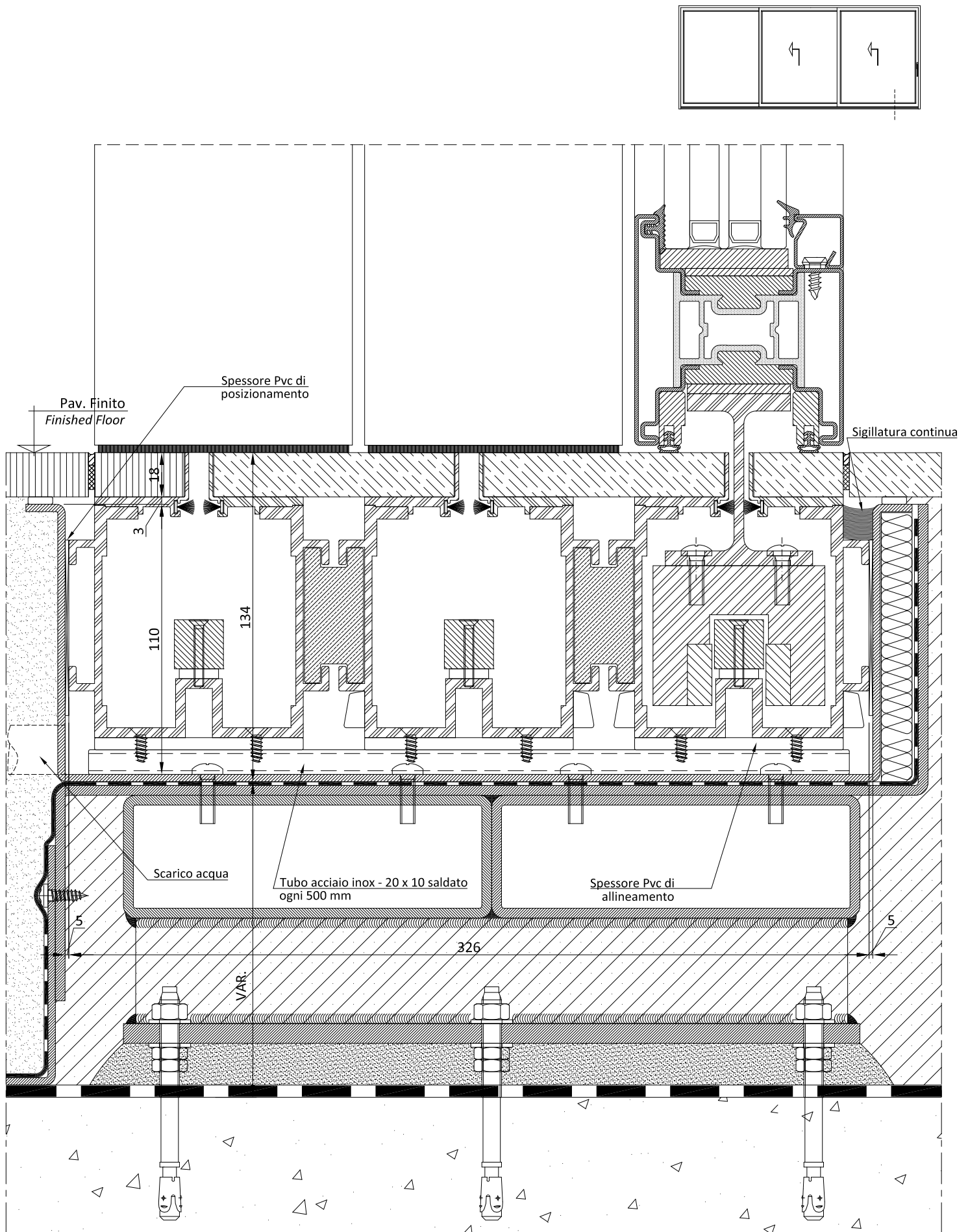

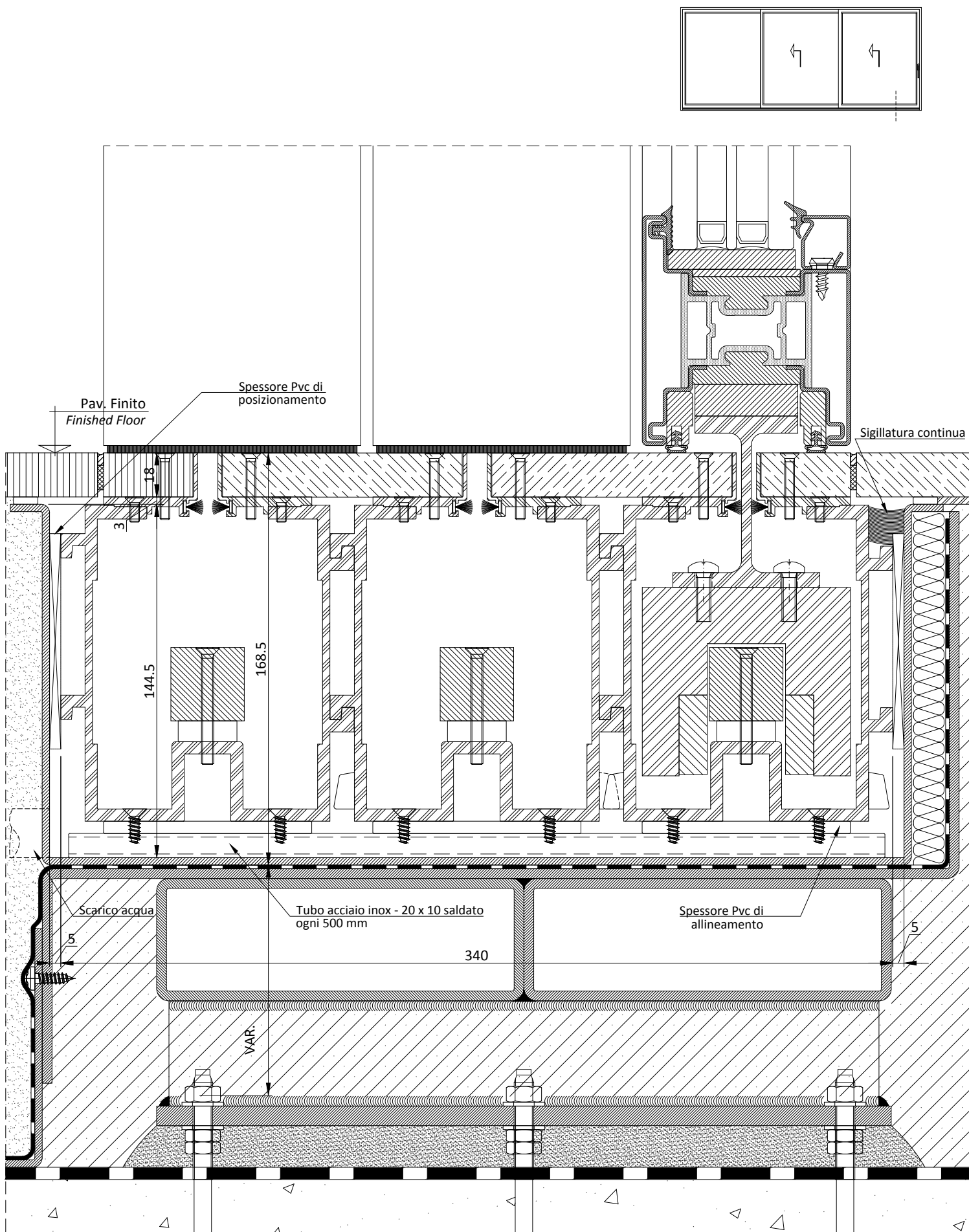

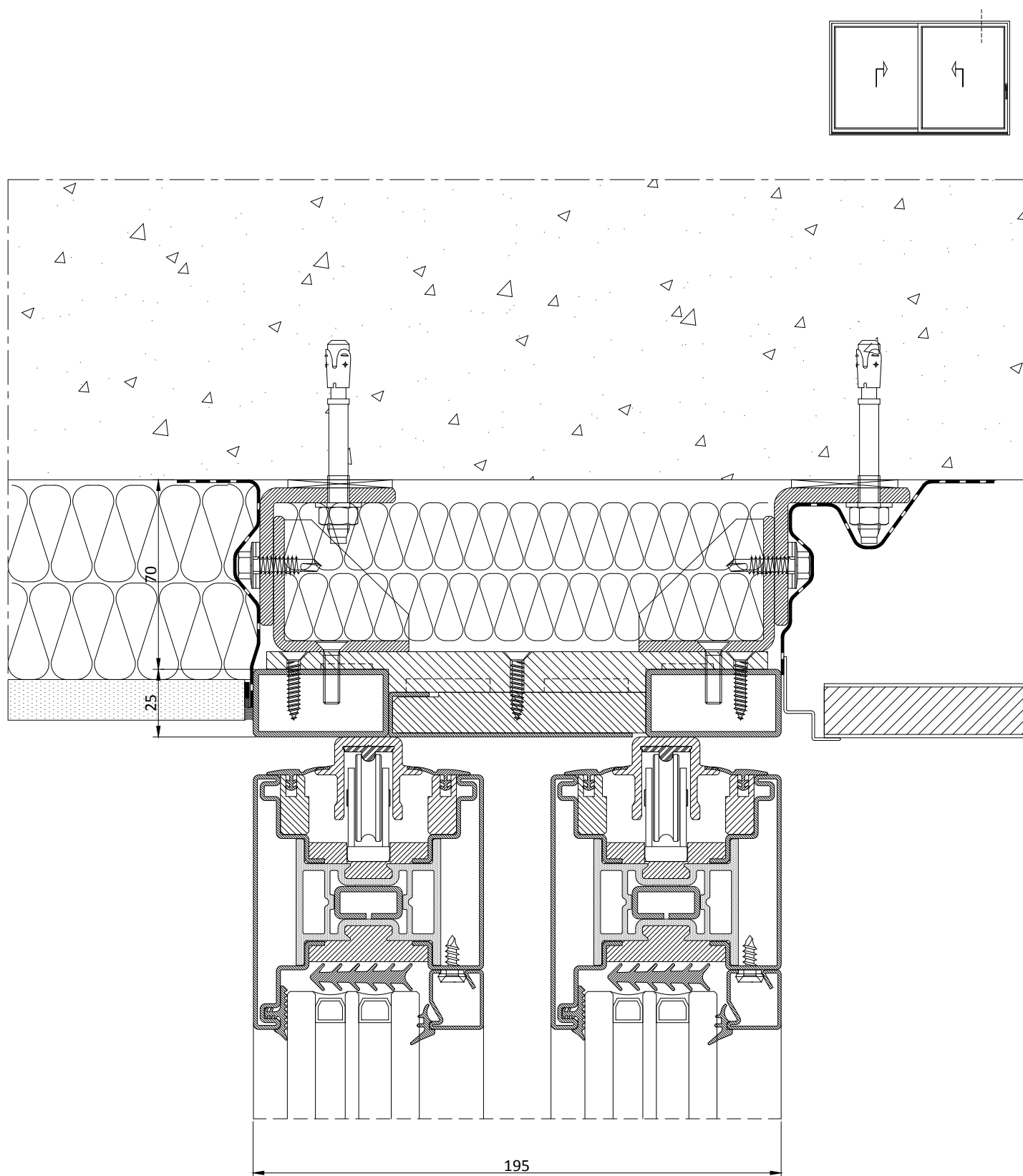

NB: Prevedere opportuni irrigidimenti della struttura di supporto (o falso telaio) in corrispondenza dei carrelli del sistema di abbassamento dell'anta, idonei a contrastare uno sforzo massimo di 300 kg/mt per ottenere l'abbassamento dell'anta nella posizione di chiusura desiderata.

NB: To foresee suitable stiffeners of the support structure (or false frame) in correspondence with the trolley of the leaf lowering system, suitable to counteract a maximum strength of 300 kg/mt for obtaining the leaf lowering to the desired closed position

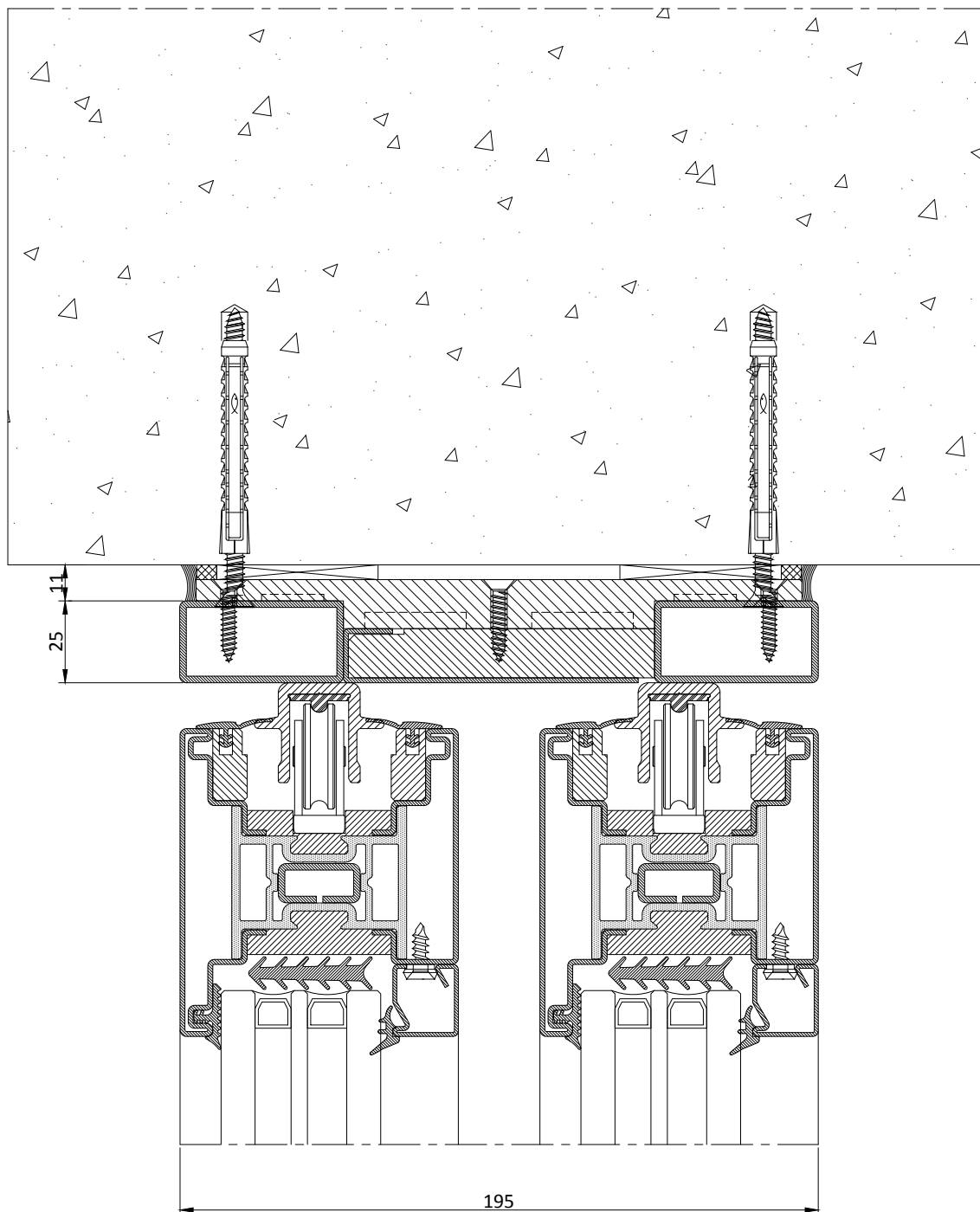
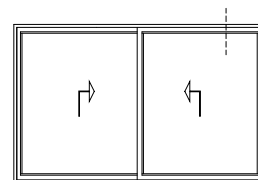

NB: Prevedere opportuni irrigidimenti della struttura di supporto (o falso telaio) in corrispondenza dei carrelli del sistema di abbassamento dell'anta, idonei a contrastare uno sforzo massimo di 300 kg/mt per ottenere l'abbassamento dell'anta nella posizione di chiusura desiderata.

NB: To foresee suitable stiffeners of the support structure (or false frame) in correspondence with the trolley of the leaf lowering system, suitable to counteract a maximum strength of 300 kg/mt for obtaining the leaf lowering to the desired closed position



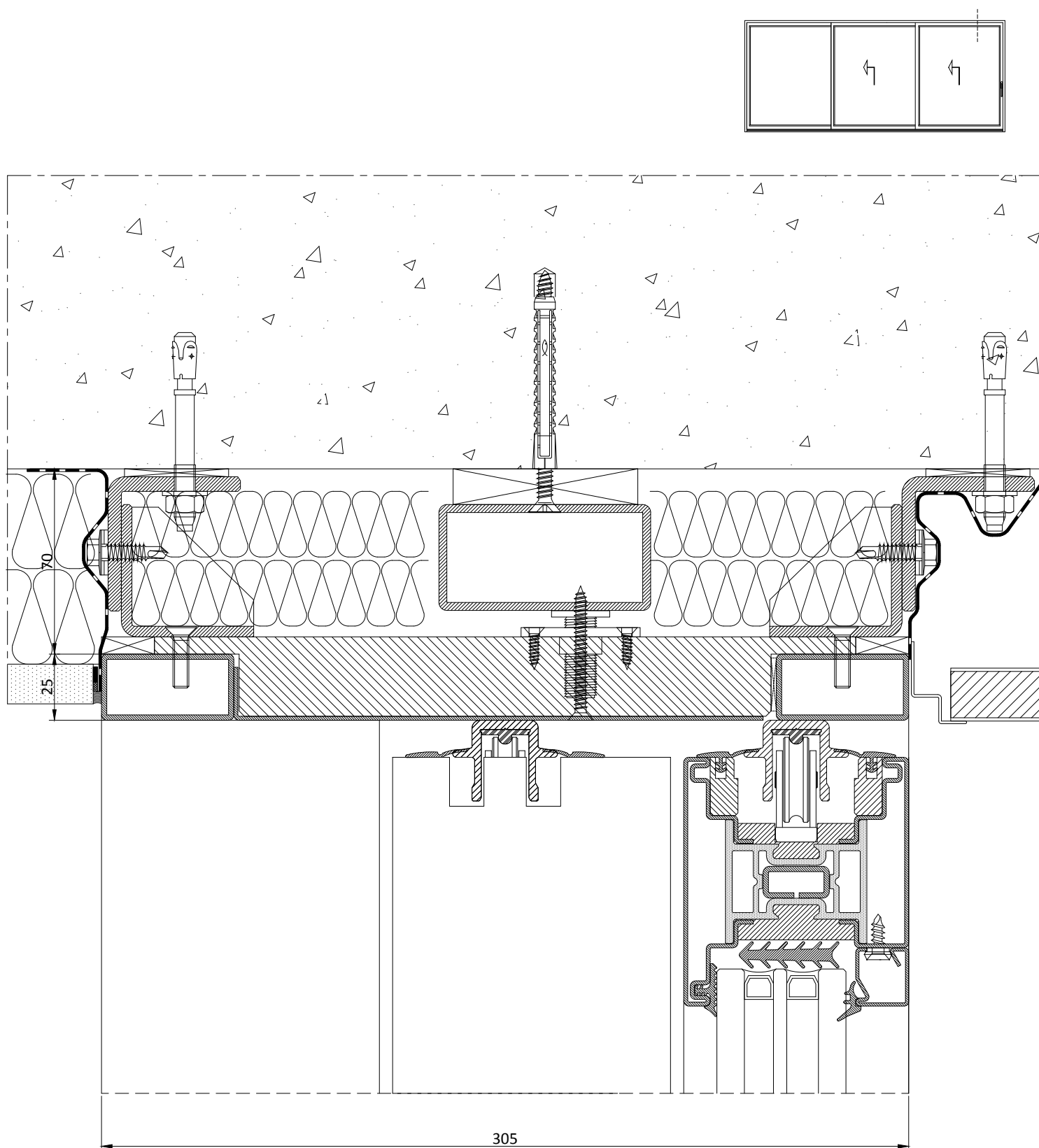

NB: Prevedere opportuni irrigidimenti della struttura di supporto (o falso telaio) in corrispondenza dei carrelli del sistema di abbassamento dell'anta, idonei a contrastare uno sforzo massimo di 300 kg/mt per ottenere l'abbassamento dell'anta nella posizione di chiusura desiderata.

NB: To foresee suitable stiffeners of the support structure (or false frame) in correspondence with the trolly of the leaf lowering system, suitable to counteract a maximum strenght of 300 kg/mt for obtaining the leaf lowering to the desired closed position

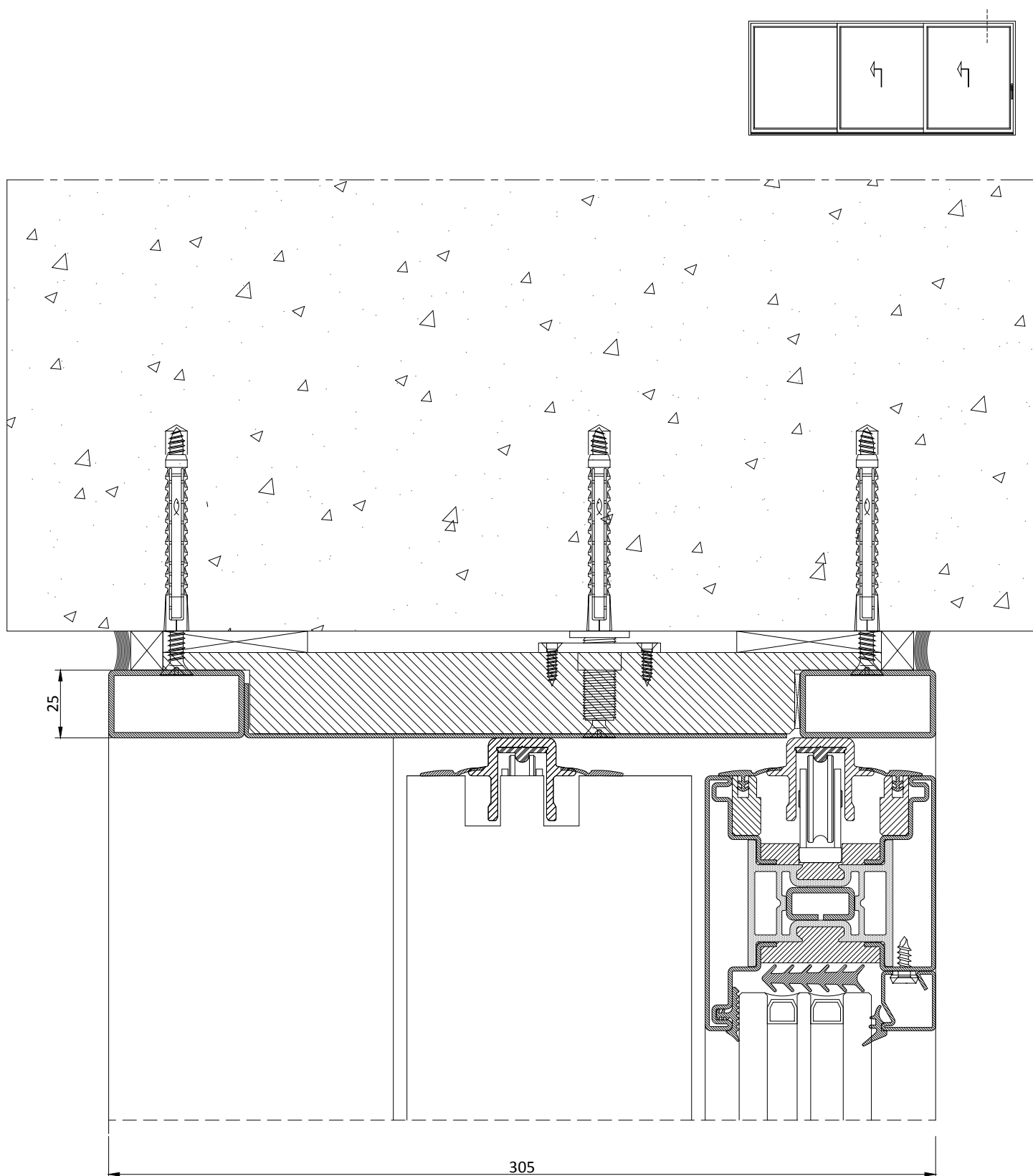

NB: Prevedere opportuni irrigidimenti della struttura di supporto (o falso telaio) in corrispondenza dei carrelli del sistema di abbassamento dell'anta, idonei a contrastare uno sforzo massimo di 300 kg/mt per ottenere l'abbassamento dell'anta nella posizione di chiusura desiderata.

NB: To foresee suitable stiffeners of the support structure (or false frame) in correspondence with the trolley of the leaf lowering system, suitable to counteract a maximum strength of 300 kg/mt for obtaining the leaf lowering to the desired closed position

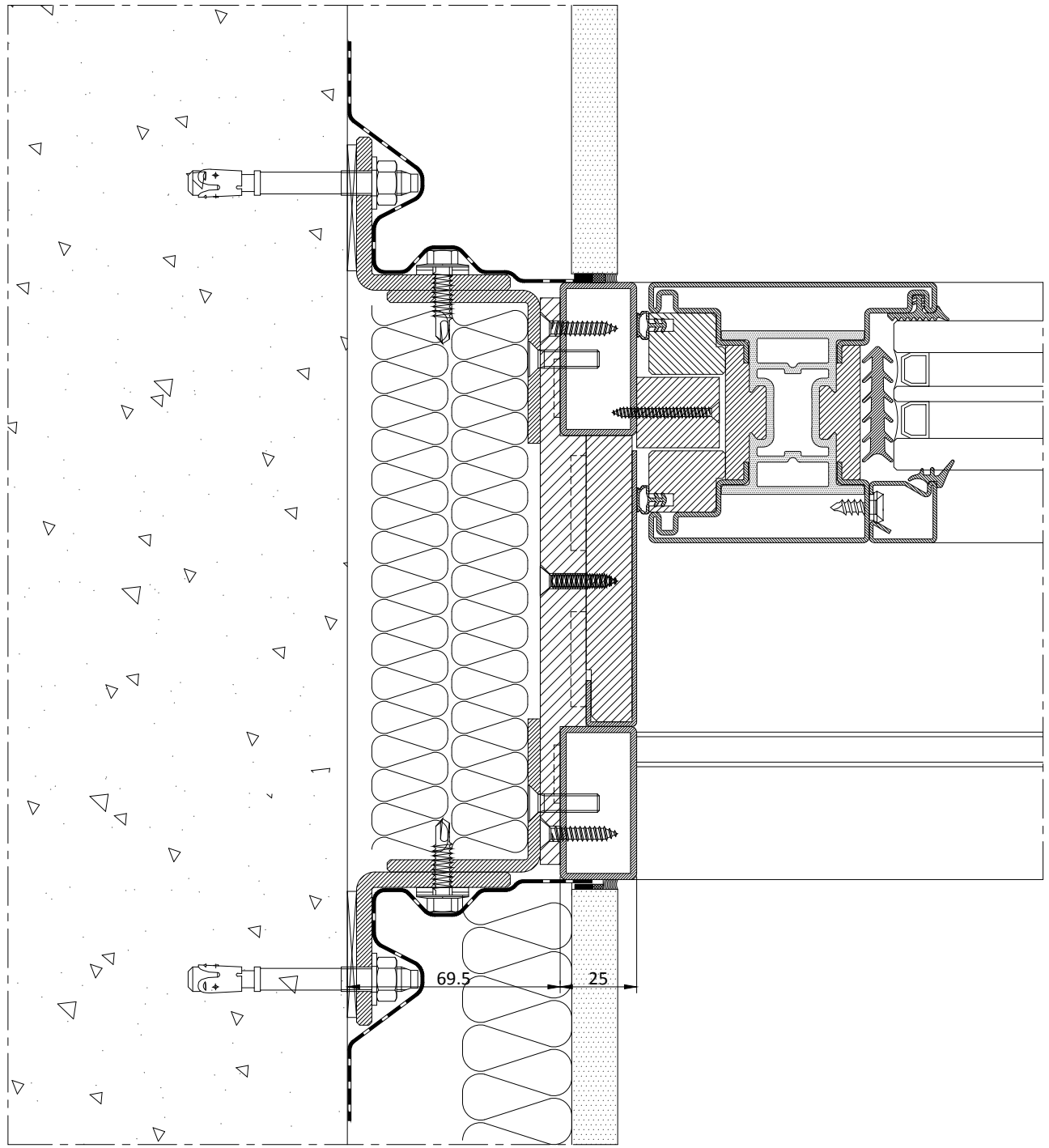
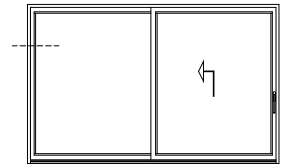

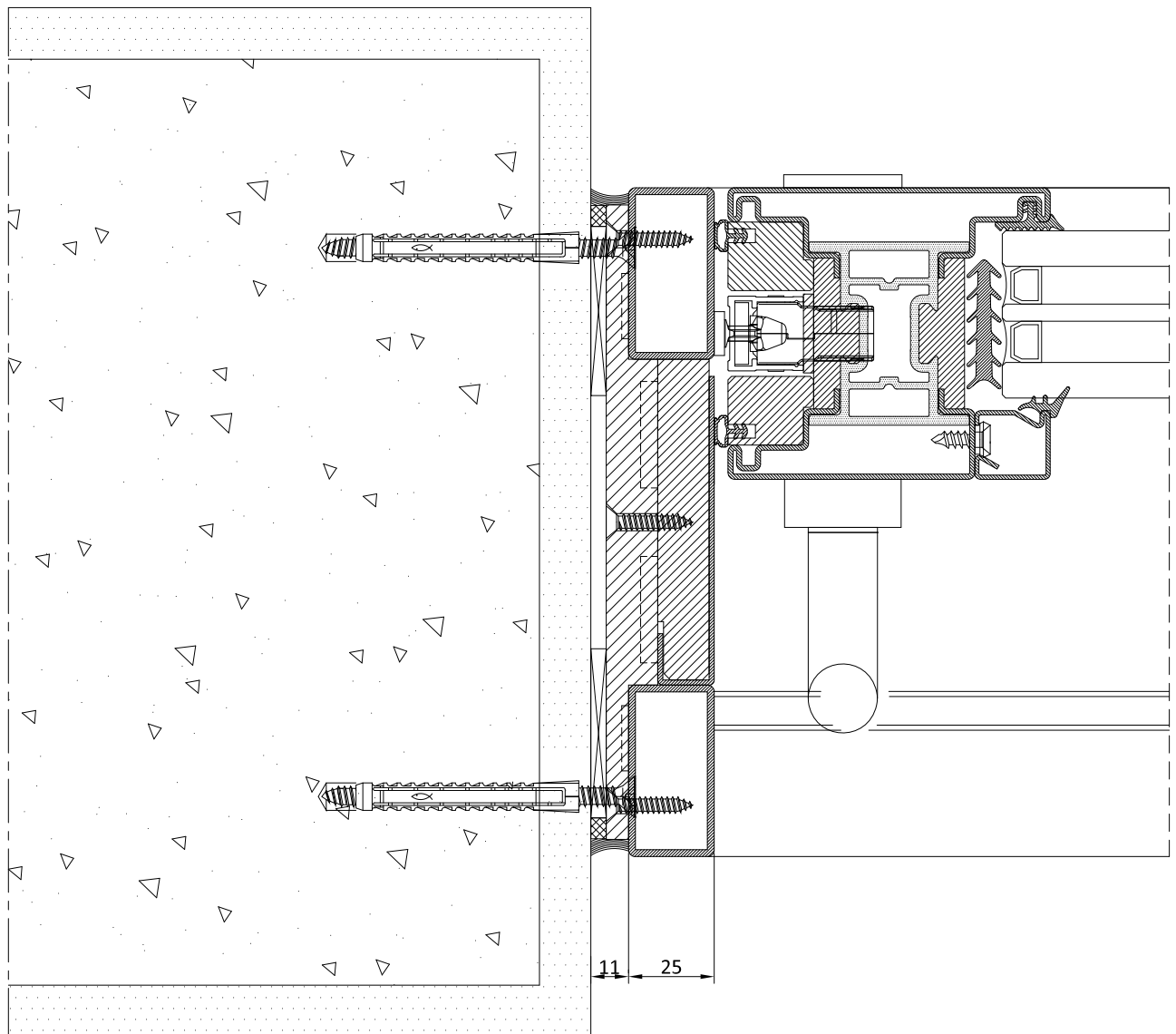
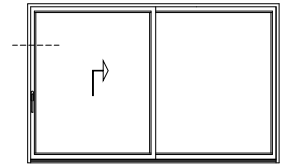

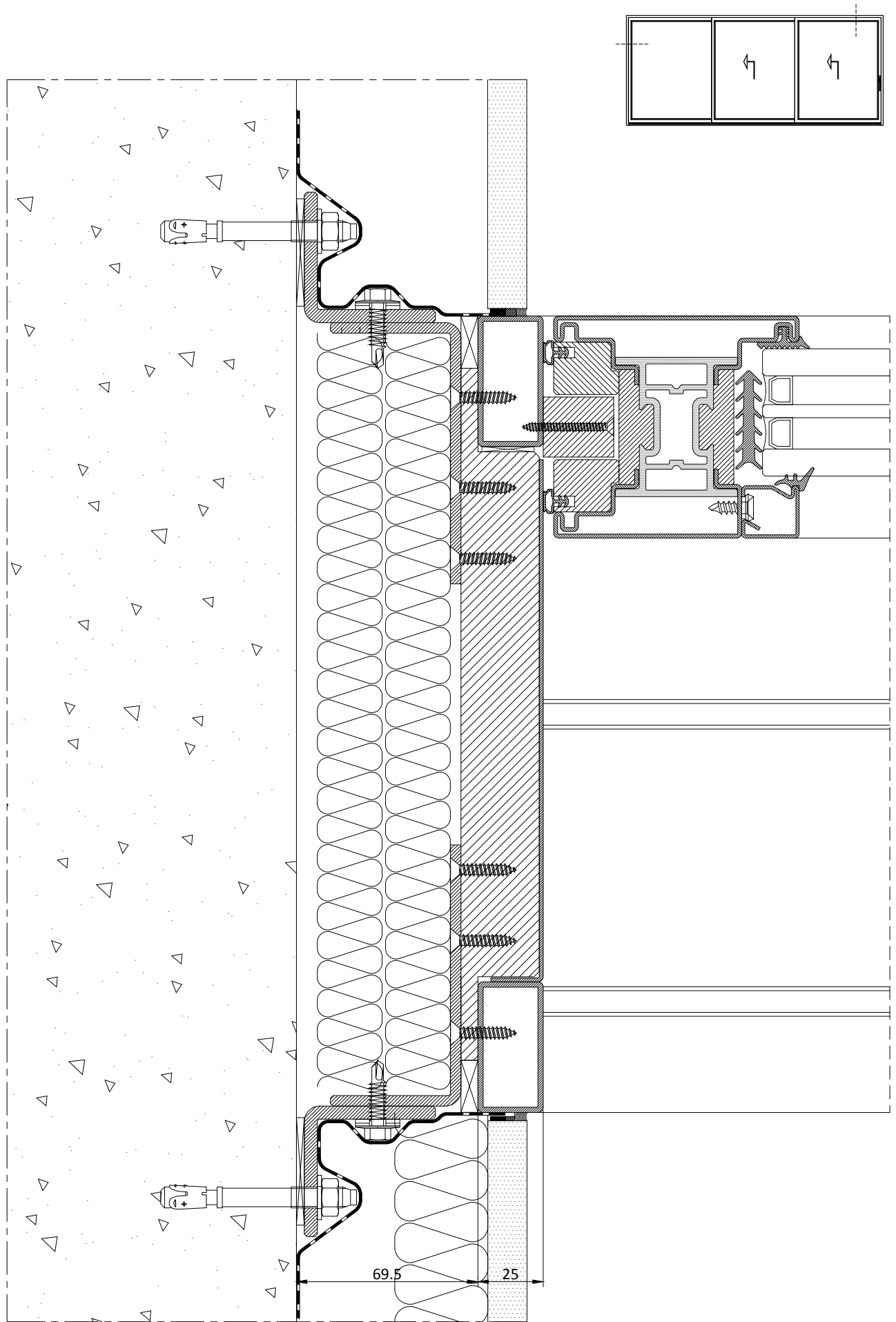

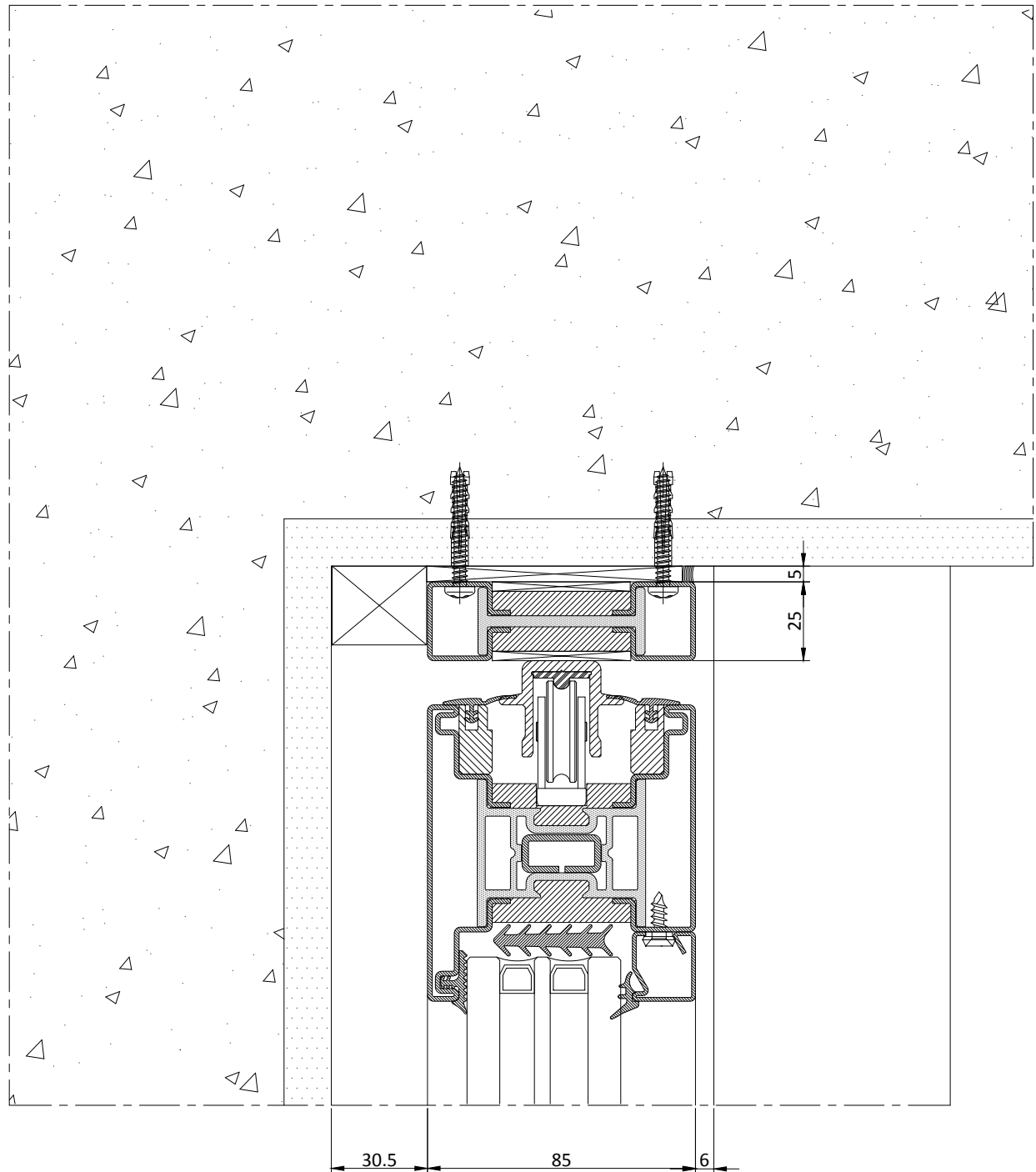
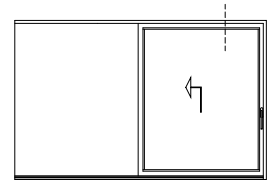

NB: Prevedere opportuni irrigidimenti della struttura di supporto (o falso telaio) in corrispondenza dei carrelli del sistema di abbassamento dell'anta, idonei a contrastare uno sforzo massimo di 300 kg/mt per ottenere l'abbassamento dell'anta nella posizione di chiusura desiderata.

NB: To foreseen suitable stiffeners of the support structure (or false frame) in correspondence with the trolley of the leaf lowering system, suitable to counteract a maximum strength of 300 kg/mt for obtaining the leaf lowering to the desired closed position

**Distinta di taglio e lista componenti | Cutting list and components list**

Le distinte di taglio e le liste accessori individuate per le diverse tipologie sono state redatte per un serramento tipo. E' compito dei tecnici specializzati delle ditte produttrici analizzare criticamente tali indicazioni al fine di verificare la compatibilità del tipo e numero di accessori previsti con il serramento oggetto della commessa reale.

*The cutting and hardware lists, which have been identified for the different typologies, have been produced for a standard window. The window manufacturers' specialized technicians will have to critically analyze such information in order to verify the compatibility of both the type and the number of accessories provided with the window object of the real order.*

Schema | Type A

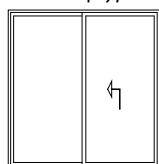

Schema | Type B

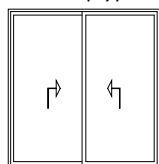

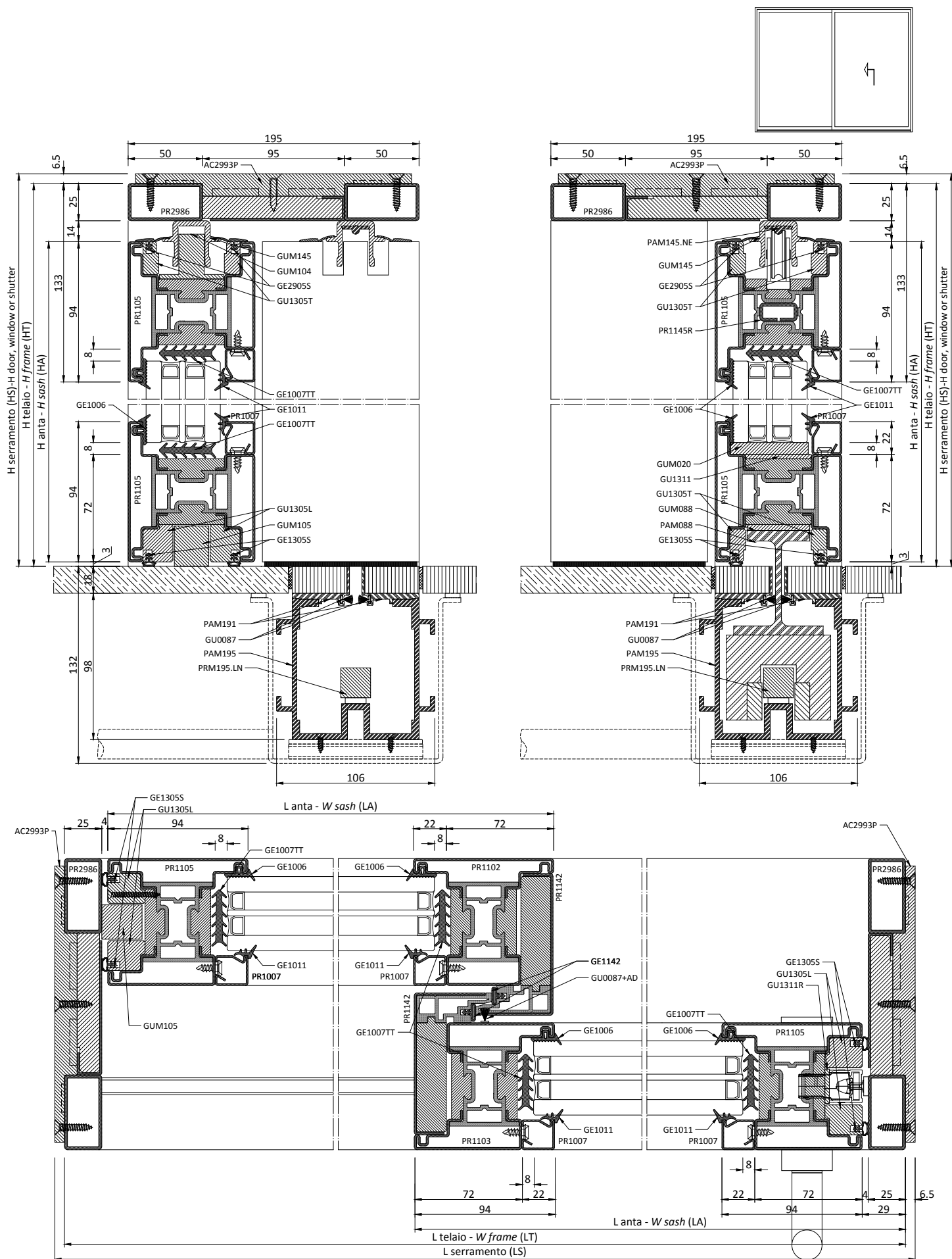



| PROFILI                |   | PROFILES  |      |                     |                |
|------------------------|---|---|------|---------------------|----------------|
| Cod.                   | Descrizione   | Description   | n°   | Dim.                | Taglio/Cutting |
| <b>Telaio</b>          |   | <b>Frame</b>  |      |                     |                |
| PR2986                 | Profilo "Tubolare"  | "Rectangular" profile                                 | 2    | LT                  | 90 90          |
|                        | Profilo "Tubolare"  | "Rectangular" profile                                 | 2    | HT-12               | 90 90          |
|                        | Profilo "Tubolare"  | "Rectangular" profile                                 | 2    | HT-12               | 90 90          |
|                        | Estruso centrale di unione                                    | Central extrusion junction                            | 2    | LT/2                | 90 90          |
|                        | Estruso centrale di unione                                    | Central extrusion junction                            | 2    | HT-12               | 90 90          |
|                        | Profilo centrale a "C"  | "C" profile   | 2    | LT/2-2,5            | 90 90          |
|                        | Profilo centrale a "C"  | "C" profile   | 2    | HT-12               | 90 90          |
| <b>Guida inferiore</b> |   | <b>Inferior Rail</b>                                  |      |                     |                |
| PAM088                 | Profilo interfaccia anta/pattini                              | Sash/skid interface profile                           | 1    | LT/2-102            | 90 90          |
| PAM191                 | Profilo di supporto pavimento                                 | Profile support of the floor                          | 2    | LT-50               | 90 90          |
| PAM195                 | Profilo di contenimento pattino                               | Alignment profile for magnetic device                 | 1    | LT                  | 90 90          |
| PRM195.LN              | Profilo guida ferro magnetica                                 | Ferromagnetic rail                                    | 2    | LT/2-35             | 90 90          |
| <b>Guide superiori</b> |   | <b>Upper Rail</b>                                     |      |                     |                |
| GUM145                 | Profilo guida superiore anta mobile                           | Upper rail of sliding sash                            | 1    | LT-50               | 90 90          |
|                        | Profilo guida superiore anta fissa                            | Upper rail of fixed sash                              | 1    | LT/2                | 90 90          |
| PAM145.NE              | Profilo guida superiore in alluminio anta mobile              | Aluminium upper guide for movable sash                | 1    | LT-50               | 90 90          |
| GUM104                 | Profilo Pvc superiore anta fissa                              | Upper PVC profile for fixed sash                      | 1    | LT/2                | 90 90          |
| <b>Anta</b>            |   | <b>Sash</b>   |      |                     |                |
| PR1105                 | Profilo zoccolo   | Bottom rail profile                                   | 4    | LT/2+18             | 45 45          |
|                        | Profilo zoccolo   | Bottom rail profile                                   | 2    | HT-42               | 45 45          |
| PR1102                 | Profilo a "T"   | "T" profile   | 1    | HT-42               | 45 45          |
| PR1103                 | Profilo a "Z"   | "Z" profile   | 1    | HT-42               | 45 45          |
| PR1142                 | Profilo labirinto centrale - anta mobile (Parte metallica)    | Central labyrinth profile - sliding sash (Metal part) | 1    | HT-42               | 90 90          |
|                        | Profilo labirinto centrale - anta mobile (Parte plastica)     | Central labyrinth profile - sliding sash (Pvc part)   | 1    | HT-82               | 90 90          |
|                        | Profilo labirinto centrale - anta fissa (Parte metallica)     | Central labyrinth profile - fixed sash (Metal part)   | 1    | HT-30               | 90 90          |
|                        | Profilo labirinto centrale - anta fissa (Parte plastica)      | Central labyrinth profile - fixed sash (Pvc part)     | 1    | HT-70               | 90 90          |
| GU1305L                | Profilo laterale porta guarnizione                            | Side profile for rebate gasket support                | 1    | LT/2-5              | 45 90          |
| GU1305L                | Profilo laterale porta guarnizione                            | Side profile for rebate gasket support                | 1    | LT/2-5              | 90 45          |
| GU1305L                | Profilo laterale porta guarnizione                            | Side profile for rebate gasket support                | 4    | HT-42               | 45 45          |
| GU1305T                | Profilo Pvc porta guarnizione sup./inf.                       | Upper/bottom profile for rebate gasket support        | 6    | LT/2-5              | 90 45          |
| GUM105                 | Profilo pvc fissaggio inferiore/laterale anta fissa           | side/bottom PVC profile for fixed sash                | 1    | LT/2-35             | 90 90          |
| GUM105                 | Profilo pvc fissaggio inferiore/laterale anta fissa           | Pvc profile bottom/side fixing fixed sash             | 1    | HT-65               | 90 90          |
| GUM088                 | Profilo Pvc interfaccia anta profilo PAM088                   | Profile between sash and profile PAM088               | 1    | LT/2-102            | 90 90          |
| PR1145R                | Profilo di rinforzo   | Reinforcement profile                                 | 1    | LT/2-110            | 90 90          |
| <b>Fermavetri</b>      |   | <b>Glazing beads</b>                                  |      |                     |                |
| PR1007                 | Profilo fermavetro  | Glazing bead profile                                  | 4    | LT/2-126            | 90 90          |
|                        | Profilo fermavetro  | Glazing bead profile                                  | 4    | HT-230              | 90 90          |
| <b>Vetri</b>           |   | <b>Glass unit</b>                                     |      |                     |                |
|                        | Vetrocamera   | Double glazing  | 2    | (LT/2-142)x(HT-202) |                |
| <b>ACCESSORI</b>       |   | <b>HARDWARE</b>                                       |      |                     |                |
| Cod.                   | Descrizione   | Description   | n°   | Note/ Notes         |                |
| AC1305G                | Guarnizione d'angolo vulcanizzata per GE1305S                 | Vulcanised corner weather strip for GE1305S           | 4    |                     |                |
| AC1020XL               | Supporto spessore vetro                                       | Glass spacer  | 18   |                     |                |
| AC2993P                | Accessorio assiemaggio telaio                                 | Frame assemblage accessory                            | var. |                     |                |
| ACM195                 | Accessorio assiemaggio profilo contenimento pattini magnetici | Accessory for profile support for magnetic device     | var. |                     |                |
| AG2992.AB              | Rostro aggiuntivo   | Additional hook bolt                                  | opz. |                     |                |
| CV5001.                | Viti per boccole fermavetro                                   | Screw for glazing bead bushing                        | var. |                     |                |
| CV5012.                | Boccole per fermavetro  | Bushing for glazing bead                              | var. |                     |                |
| AGM086/7A.x            | Kit movimentazione e tenuta 1 anta apribile una fissa         | 1 leaf handling and sealing kit                       | 1    |                     |                |
| AC110SEF               | Kit squadrette di giunzione angoli Acciaio inox               | Corner joint Stainless steel                          | 1    |                     |                |
| AC110SIA               | Kit squadrette di giunzione angoli Acciaio inox               | Corner joint Stainless steel                          | 1    |                     |                |
| AC290SPI               | Kit giunzione angolo telaio                                   | Frame corner joint kit                                | 1    |                     |                |
| Vedi Pag. 2.5.1        | Maniglione  | Handle  | 1    |                     |                |
| <b>GUARNIZIONI</b>     |   | <b>GASKETS</b>  |      |                     |                |
| Cod.                   | Descrizione   | Description   | n°   | Dim.                |                |
| GE1305S                | Guarnizione laterale e inferiore ante                         | Sash uproghts an bottom rail gasket                   | 1    | 4xHT + 2xLT         |                |
| GE1006                 | Guarnizione esterna vetro                                     | External gasket                                       | 1    | 4xHT + 2xLT         |                |
| GE1007TT               | Guarnizione sotto vetro                                       | Under glass gasket                                    | 1    | 4xHT + LT           |                |
| GE1011                 | Guarnizione interna vetro                                     | Internal glass gasket                                 | 1    | 4xHT + 2xLT         |                |
| GE1142                 | Guarnizione di tenuta labirinto                               | Labyrinth sealing gasket                              | 2    | HT                  |                |
| GE2905S                | Guarnizione superiore ante                                    | Top-rail gasket                                       | 2    | LT                  |                |
| GU0087+AD              | Spazzolino per labirinto + adesivo                            | Brush for corner joint + adhesive                     | 1    | HT                  |                |
| GU0087                 | Spazzolino per profilo contenimento pattini                   | Brush for profile support for magnetic device         | 2    | LT                  |                |
| GUM020                 | Profilo spessoramento sotto vetro                             | Under glass profile                                   | 1    | LT/2                |                |
| GU1311                 | Profilo Pvc compensazione                                     | Compensation Pvc profile                              | 1    | LT/2                |                |
| GU1311R                | Profilo Pvc compensazione                                     | Compensation Pvc profile                              | 1    | HT-92               |                |

\* Le dimensioni delle guarnizioni sono indicative e devono essere aumentate del 10% per adattamenti e ritiri del materiale nel tempo

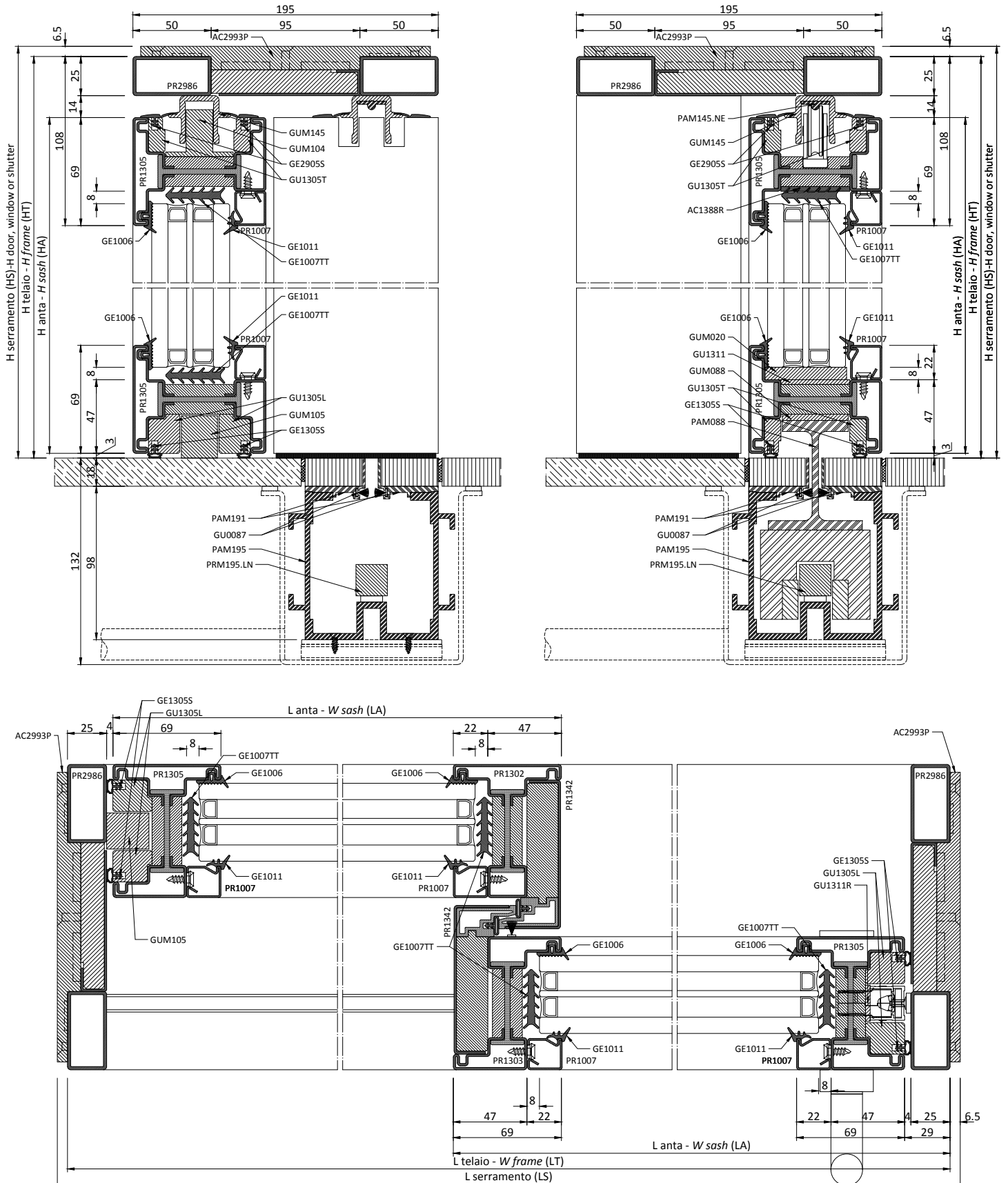

| PROFILI                |   | PROFILES  |      |                       |                |
|------------------------|---|---|------|-----------------------|----------------|
| Cod.                   | Descrizione   | Description   | n°   | Dim.                  | Taglio/Cutting |
| <b>Telaio</b>          |   | <b>Frame</b>  |      |                       |                |
| PR2986                 | Profilo "Tubolare"  | "Rectangular" profile                                 | 2    | LT                    | 90 90          |
|                        | Profilo "Tubolare"  | "Rectangular" profile                                 | 2    | HT-12                 | 90 90          |
|                        | Profilo "Tubolare"  | "Rectangular" profile                                 | 2    | HT-12                 | 90 90          |
|                        | Estruso centrale di unione                                    | Central extrusion junction                            | 2    | LT/2                  | 90 90          |
|                        | Estruso centrale di unione                                    | Central extrusion junction                            | 2    | HT-12                 | 90 90          |
|                        | Profilo centrale a "C"  | "C" profile   | 2    | LT/2-2,5              | 90 90          |
|                        | Profilo centrale a "C"  | "C" profile   | 2    | HT-12                 | 90 90          |
| <b>Guida inferiore</b> |   | <b>Inferior Rail</b>                                  |      |                       |                |
| PAM088                 | Profilo interfaccia anta/pattini                              | Sash/skid interface profile                           | 1    | LT/2-114,5            | 90 90          |
| PAM191                 | Profilo di supporto pavimento                                 | Profile support of the floor                          | 2    | LT-50                 | 90 90          |
| PAM195                 | Profilo di contenimento pattino                               | Alignment profile for magnetic device                 | 1    | LT                    | 90 90          |
| PRM195.LN              | Profilo guida ferro magnetica                                 | Ferromagnetic rail                                    | 2    | LT/2-35               | 90 90          |
| <b>Guide superiori</b> |   | <b>Upper Rail</b>                                     |      |                       |                |
| GUM145                 | Profilo guida superiore anta mobile                           | Upper rail of sliding sash                            | 1    | LT-50                 | 90 90          |
|                        | Profilo guida superiore anta fissa                            | Upper rail of fixed sash                              | 1    | LT/2                  | 90 90          |
| PAM145.NE              | Profilo guida superiore in alluminio anta mobile              |   | 1    | LT-50                 | 90 90          |
| GUM104                 | Profilo Pvc superiore anta fissa                              |   | 1    | LT/2                  | 90 90          |
| <b>Anta</b>            |   | <b>Sash</b>   |      |                       |                |
| PR1305                 | Profilo zoccolo   | Bottom rail profile                                   | 4    | LT/2+5,5              | 45 45          |
|                        | Profilo zoccolo   | Bottom rail profile                                   | 2    | HT-42                 | 45 45          |
| PR1302                 | Profilo a "T"   | "T" profile   | 1    | HT-42                 | 45 45          |
| PR1303                 | Profilo a "Z"   | "Z" profile   | 1    | HT-42                 | 45 45          |
| PR1342                 | Profilo labirinto centrale - anta mobile (Parte metallica)    | Central labyrinth profile - sliding sash (Metal part) | 1    | HT-42                 | 90 90          |
|                        | Profilo labirinto centrale - anta mobile (Parte plastica)     | Central labyrinth profile - sliding sash (Pvc part)   | 1    | HT-82                 | 90 90          |
|                        | Profilo labirinto centrale - anta fissa (Parte metallica)     | Central labyrinth profile - fixed sash (Metal part)   | 1    | HT-30                 | 90 90          |
|                        | Profilo labirinto centrale - anta fissa (Parte plastica)      | Central labyrinth profile - fixed sash (Pvc part)     | 1    | HT-70                 | 90 90          |
| GU1305L                | Profilo laterale porta guarnizione                            | Side profile for rebate gasket support                | 1    | LT/2-17               | 45 90          |
| GU1305L                | Profilo laterale porta guarnizione                            | Side profile for rebate gasket support                | 1    | LT/2-17               | 90 45          |
| GU1305L                | Profilo laterale porta guarnizione                            | Side profile for rebate gasket support                | 4    | HT-42                 | 45 45          |
| GU1305T                | Profilo Pvc porta guarnizione sup./inf.                       | Upper/bottom profile for rebate gasket support        | 6    | LT/2-17               | 90 45          |
| GUM105                 | Profilo pvc fissaggio inferiore/laterale anta fissa           | side/bottom PVC profile for fixed sash                | 1    | LT/2-45               | 90 90          |
| GUM105                 | Profilo pvc fissaggio inferiore/laterale anta fissa           | Pvc profile bottom/side fixing fixed sash             | 1    | HT-65                 | 90 90          |
| GUM088                 | Profilo Pvc interfaccia anta profilo PAM088                   | Profile between sash and profile PAM088               | 1    | LT/2-114,5            | 90 90          |
| <b>Fermavetri</b>      |   | <b>Glazing beads</b>                                  |      |                       |                |
| PR1007                 | Profilo fermavetro  | Glazing bead profile                                  | 4    | LT/2-88,5             | 90 90          |
|                        | Profilo fermavetro  | Glazing bead profile                                  | 4    | HT-180                | 90 90          |
| <b>Vetri</b>           |   | <b>Glass unit</b>                                     |      |                       |                |
|                        | Vetrocamera   | Double glazing  | 2    | (LT/2-104,5)x(HT-152) |                |
| <b>ACCESSORI</b>       |   | <b>HARDWARE</b>                                       |      |                       |                |
| Cod.                   | Descrizione   | Description   | n°   | Note/Notes            |                |
| AC1305G                | Guarnizione d'angolo vulcanizzata per GE1305S                 | Vulcanised corner weather strip for GE1305S           | 4    |                       |                |
| AC1020XL               | Supporto spessore vetro                                       | Glass spacer  | 18   |                       |                |
| AC2993P                | Accessorio assiemaggio telaio                                 | Frame assemblage accessory                            | var. |                       |                |
| AC1388R.xx             | Piatti di fissaggio carrelli su ante con profili ridotti      | Fixing plates for rollers on reduce profile           | 1    |                       |                |
| ACM195                 | Accessorio assiemaggio profilo contenimento pattini magnetici | Accessory for profile support for magnetic device     | var. |                       |                |
| AG2992.AB              | Rostro aggiuntivo   | Additional hook bolt                                  | opz. |                       |                |
| AC1363R                | Rinforzo giunzione d'angolo                                   | Corner joint reinforcement                            | 4    |                       |                |
| CV5001.                | Viti per boccole fermavetro                                   | Screw for glazing bead bushing                        | var. |                       |                |
| CV5012.                | Boccole per fermavetro  | Bushing for glazing bead                              | var. |                       |                |
| AGM386/7A.x            | Kit movimentazione e tenuta 1 anta apribile una fissa         | 1 leaf handling and sealing kit                       | 1    |                       |                |
| AC110RNE               | Kit squadrette di giunzione angoli Acciaio inox               | Corner joint Stainless steel                          | 1    |                       |                |
| AC110RNI               | Kit squadrette di giunzione angoli Acciaio inox               | Corner joint Stainless steel                          | 1    |                       |                |
| AC290SPI               | Kit giunzione angolo telaio                                   | Frame corner joint kit                                | 1    |                       |                |
| Vedi Pag. 2.5.1        | Maniglione  | Handle  | 1    |                       |                |
| <b>GUARNIZIONI</b>     |   | <b>GASKETS</b>  |      |                       |                |
| Cod.                   | Descrizione   | Description   | n°   | Dim.                  |                |
| GE1305S                | Guarnizione laterale e inferiore ante                         | Sash uproghts an bottom rail gasket                   | 1    | 4xHT + 2xLT           |                |
| GE1006                 | Guarnizione esterna vetro                                     | External gasket                                       | 1    | 4xHT + 2xLT           |                |
| GE1007TT               | Guarnizione sotto vetro                                       | Under glass gasket                                    | 1    | 4xHT + LT             |                |
| GE1011                 | Guarnizione interna vetro                                     | Internal glass gasket                                 | 1    | 4xHT + 2xLT           |                |
| GE1142                 | Guarnizione di tenuta labirinto                               | Labyrinth sealing gasket                              | 2    | HT                    |                |
| GE2905S                | Guarnizione superiore ante                                    | Top-rail gasket                                       | 2    | LT                    |                |
| GU0087+AD              | Spazzolino per labirinto + adesivo                            | Brush for corner joint + adhesive                     | 1    | HT                    |                |
| GU0087                 | Spazzolino per profilo contenimento pattini                   | Brush for profile support for magnetic device         | 2    | LT                    |                |
| GUM020                 | Profilo spessoramento sotto vetro                             | Under glass profile                                   | 1    | LT/2                  |                |
| GU1311                 | Profilo Pvc compensazione                                     | Compensation Pvc profile                              | 1    | LT/2                  |                |
| GU1311R                | Profilo Pvc compensazione                                     | Compensation Pvc profile                              | 1    | HT-92                 |                |

\* Le dimensioni delle guarnizioni sono indicative e devono essere aumentate del 10% per adattamenti e ritiri del materiale nel tempo

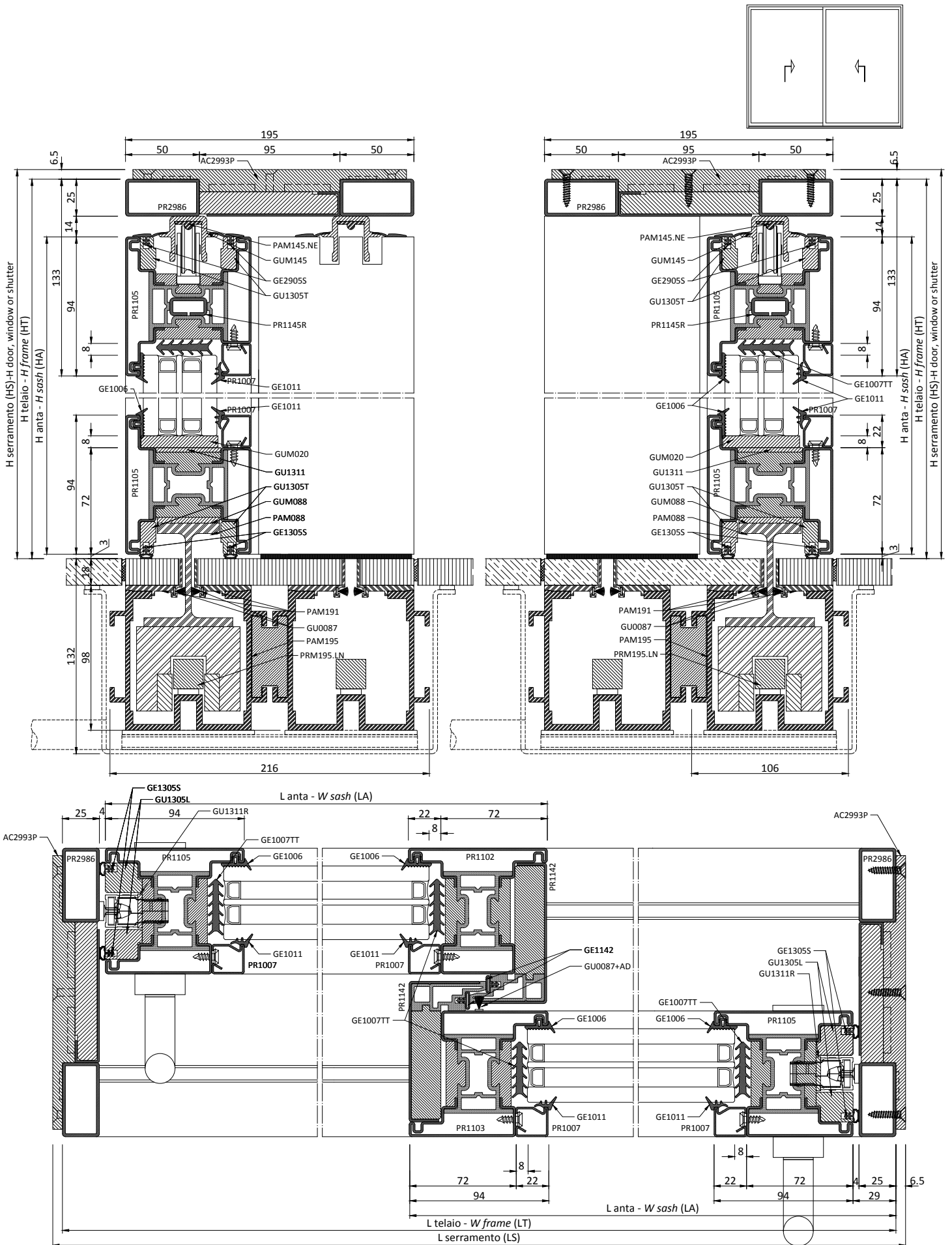

| PROFILI                |  | PROFILES   |      |                     |                |
|------------------------|--|--|------|---------------------|----------------|
| Cod.                   | Descrizione  | Description  | n°   | Dim.                | Taglio/Cutting |
| <b>Telaio</b>          |  | <b>Frame</b>   |      |                     |                |
| PR2986                 | Profilo "Tubolare"   | "Rectangular" profile                                  | 2    | LT                  | 90 90          |
|                        | Profilo "Tubolare"   | "Rectangular" profile                                  | 2    | HT-12               | 90 90          |
|                        | Profilo "Tubolare"   | "Rectangular" profile                                  | 2    | HT-12               | 90 90          |
|                        | Estruso centrale di unione                                 | Central extrusion junction                             | 2    | LT/2                | 90 90          |
|                        | Estruso centrale di unione                                 | Central extrusion junction                             | 2    | HT-12               | 90 90          |
|                        | Profilo centrale a "C"                                     | "C" profile  | 2    | LT/2-2,5            | 90 90          |
|                        | Profilo centrale a "C"                                     | "C" profile  | 2    | HT-12               | 90 90          |
| <b>Guida inferiore</b> |  | <b>Inferior Rail</b>                                   |      |                     |                |
| PAM088                 | Profilo interfaccia anta/pattini                           | Sash/skid interface profile                            | 2    | LT/2-102            | 90 90          |
| PAM191                 | Profilo di supporto pavimento                              | Profile support of the floor                           | 4    | LT-50               | 90 90          |
| PAM195                 | Profilo di contenimento pattino                            | Alignment profile for magnetic device                  | 2    | LT                  | 90 90          |
| PRM195.LN              | Profilo guida ferro magnetica                              | Ferromagnetic rail                                     | 4    | LT/2-35             | 90 90          |
| <b>Guide superiori</b> |  | <b>Upper Rail</b>                                      |      |                     |                |
| GUM145                 | Profilo guida superiore anta mobile                        | Upper rail of sliding sash                             | 2    | LT-50               | 90 90          |
| PAM145.NE              | Profilo guida superiore in alluminio anta mobile           | Upper PVC profile for fixed sash                       | 2    | LT-50               | 90 90          |
| <b>Anta</b>            |  | <b>Sash</b>  |      |                     |                |
| PR1105                 | Profilo zoccolo  | Bottom rail profile                                    | 4    | LT/2+18             | 45 45          |
|                        | Profilo zoccolo  | Bottom rail profile                                    | 2    | HT-42               | 45 45          |
| PR1102                 | Profilo a "T"  | "T" profile  | 1    | HT-42               | 45 45          |
| PR1103                 | Profilo a "Z"  | "Z" profile  | 1    | HT-42               | 45 45          |
| PR1142                 | Profilo labirinto centrale - anta mobile (Parte metallica) | Central labyrinth profile - sliding sash (Metal part)  | 2    | HT-42               | 90 90          |
|                        | Profilo labirinto centrale - anta mobile (Parte plastica)  | Central labyrinth profile - sliding sash (Pvc part)    | 2    | HT-82               | 90 90          |
| GU1305L                | Profilo laterale porta guarnizione                         | Side profile for rebate gasket support                 | 4    | HT-42               | 45 45          |
| GU1305T                | Profilo Pvc porta guarnizione sup./inf.                    | Upper/bottom profile for rebate gasket support         | 8    | LT/2-5              | 90 45          |
| GUM088                 | Profilo Pvc interfaccia anta profilo PAM088                | Profile between sash and profile PAM088                | 2    | LT/2-102            | 90 90          |
| PR1145R                | Profilo di rinforzo  | Reinforcement profile                                  | 1    | LT/2-110            | 90 90          |
| <b>Fermavetri</b>      |  | <b>Glazing beads</b>                                   |      |                     |                |
| PR1007                 | Profilo fermavetro   | Glazing bead profile                                   | 4    | LT/2-126            | 90 90          |
|                        | Profilo fermavetro   | Glazing bead profile                                   | 4    | HT-230              | 90 90          |
| <b>Vetri</b>           |  | <b>Glass unit</b>                                      |      |                     |                |
|                        | Vetrocamera  | Double glazing   | 2    | (LT/2-142)x(HT-202) |                |
| <b>ACCESSORI</b>       |  | <b>HARDWARE</b>  |      |                     |                |
| Cod.                   | Descrizione  | Description  | n°   | Note/Notes          |                |
| AC1305G                | Guarnizione d'angolo vulcanizzata per GE1305S              | Vulcanised corner weather strip for GE1305S            | 4    |                     |                |
| AC1020XL               | Supporto spessore vetro                                    | Glass spacer   | 24   |                     |                |
| AC2993P                | Accessorio assiemaggio telaio                              | Frame assemblage accessory                             | var. |                     |                |
| AC2618NE               | Scarico acqua per profilo contenimento pattini magnetici   | Water drain for or profile support for magnetic device | var. |                     |                |
| ACM195                 | Accessorio assiemaggio profilo cont. Magnetici             | Accessory for profile support for magnetic device      | var. |                     |                |
| AG2992.AB              | Rostro aggiuntivo  | Additional hook bolt                                   | opz. |                     |                |
| CV5001.                | Viti per boccole fermavetro                                | Screw for glazing bead bushing                         | var. |                     |                |
| CV5012.                | Boccole per fermavetro                                     | Bushing for glazing bead                               | var. |                     |                |
| AGM086/7B.x            | Kit movimentazione e tenuta 2 ante apribili                | 2 leaf handling and sealing kit                        | 1    |                     |                |
| AC110SEA               | Kit squadrette di giunzione angoli Acciaio inox            | Corner joint Stainless steel                           | 1    |                     |                |
| AC110SIA               | Kit squadrette di giunzione angoli Acciaio inox            | Corner joint Stainless steel                           | 1    |                     |                |
| AC290SPI               | Kit giunzione angolo telaio                                | Frame corner joint kit                                 | 1    |                     |                |
| Vedi Pag. 2.5.         | Maniglione   | Handle   | 2    |                     |                |
| <b>GUARNIZIONI</b>     |  | <b>GASKETS</b>   |      |                     |                |
| Cod.                   | Descrizione  | Description  | n°   | Dim.                |                |
| GE1305S                | Guarnizione laterale e inferiore ante                      | Sash uproghts an bottom rail gasket                    | 1    | 4xHT + 2xLT         |                |
| GE1006                 | Guarnizione esterna vetro                                  | External gasket  | 1    | 4xHT + 2xLT         |                |
| GE1007TT               | Guarnizione sotto vetro                                    | Under glass gasket                                     | 1    | 4xHT + LT           |                |
| GE1011                 | Guarnizione interna vetro                                  | Internal glass gasket                                  | 1    | 4xHT + 2xLT         |                |
| GE1142                 | Guarnizione di tenuta labirinto                            | Labyrinth sealing gasket                               | 2    | HT                  |                |
| GE2905S                | Guarnizione superiore ante                                 | Top-rail gasket  | 2    | LT                  |                |
| GU0087+AD              | Spazzolino per labirinto + adesivo                         | Brush for corner joint + adhesive                      | 1    | HT                  |                |
| GU0087                 | Spazzolino per profilo contenimento pattini                | Brush for profile support for magnetic device          | 4    | LT                  |                |
| GUM020                 | Profilo spessoramento sotto vetro                          | Under glass profile                                    | 2    | LT/2                |                |
| GU1311                 | Profilo Pvc compensazione                                  | Compensation Pvc profile                               | 2    | LT/2                |                |
| GU1311R                | Profilo Pvc compensazione                                  | Compensation Pvc profile                               | 2    | HT-92               |                |

\* Le dimensioni delle guarnizioni sono indicative e devono essere aumentate del 10% per adattamenti e ritiri del materiale nel tempo

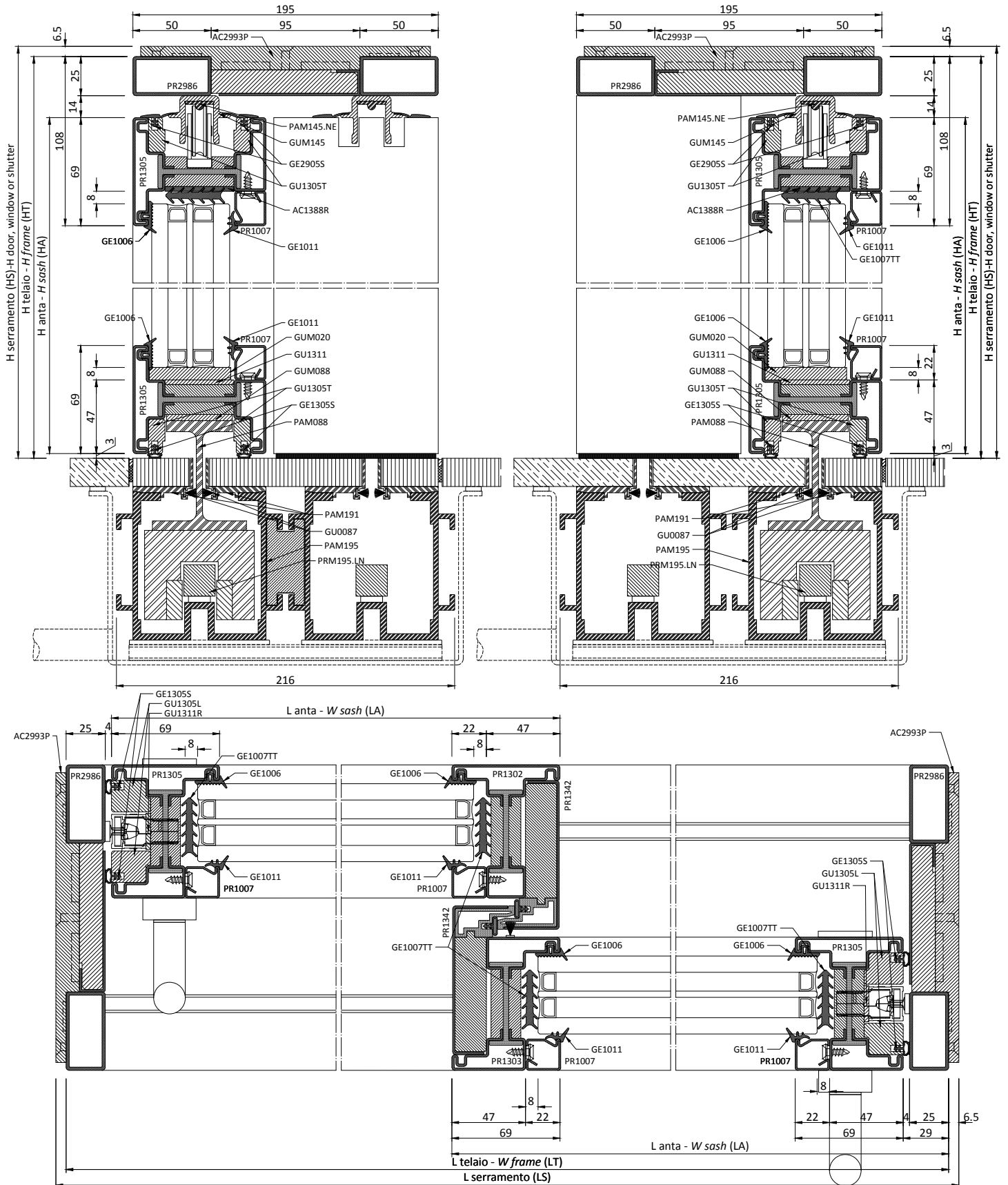

| PROFILI                |  | PROFILES   |      |                       |                |
|------------------------|--|--|------|-----------------------|----------------|
| Cod.                   | Descrizione  | Description  | n°   | Dim.                  | Taglio/Cutting |
| <b>Telaio</b>          |  | <b>Frame</b>   |      |                       |                |
| PR2986                 | Profilo "Tubolare"   | "Rectangular" profile                                  | 2    | LT                    | 90 90          |
|                        | Profilo "Tubolare"   | "Rectangular" profile                                  | 2    | HT-12                 | 90 90          |
|                        | Profilo "Tubolare"   | "Rectangular" profile                                  | 2    | HT-12                 | 90 90          |
|                        | Estruso centrale di unione                                 | Central extrusion junction                             | 2    | LT/2                  | 90 90          |
|                        | Estruso centrale di unione                                 | Central extrusion junction                             | 2    | HT-12                 | 90 90          |
|                        | Profilo centrale a "C"                                     | "C" profile  | 2    | LT/2-2,5              | 90 90          |
|                        | Profilo centrale a "C"                                     | "C" profile  | 2    | HT-12                 | 90 90          |
| <b>Guida inferiore</b> |  | <b>Inferior Rail</b>                                   |      |                       |                |
| PAM088                 | Profilo interfaccia anta/pattini                           | Sash/skid interface profile                            | 2    | LT-114,5              | 90 90          |
| PAM191                 | Profilo di supporto pavimento                              | Profile support of the floor                           | 4    | LT-50                 | 90 90          |
| PAM195                 | Profilo di contenimento pattino                            | Alignment profile for magnetic device                  | 2    | LT                    | 90 90          |
| PRM195.LN              | Profilo guida ferro magnetica                              | Ferromagnetic rail                                     | 4    | LT/2-35               | 90 90          |
| <b>Guide superiori</b> |  | <b>Upper Rail</b>                                      |      |                       |                |
| GUM145                 | Profilo guida superiore anta mobile                        | Upper rail of sliding sash                             | 2    | LT-50                 | 90 90          |
| PAM145.NE              | Profilo guida superiore in alluminio anta mobile           | Upper PVC profile for fixed sash                       | 2    | LT-50                 | 90 90          |
| <b>Anta</b>            |  | <b>Sash</b>  |      |                       |                |
| PR1305                 | Profilo zoccolo  | Bottom rail profile                                    | 4    | LT/2+5,5              | 45 45          |
|                        | Profilo zoccolo  | Bottom rail profile                                    | 2    | HT-42                 | 45 45          |
| PR1302                 | Profilo a "T"  | "T" profile  | 1    | HT-42                 | 45 45          |
| PR1303                 | Profilo a "Z"  | "Z" profile  | 1    | HT-42                 | 45 45          |
| PR1342                 | Profilo labirinto centrale - anta mobile (Parte metallica) | Central labyrinth profile - sliding sash (Metal part)  | 2    | HT-42                 | 90 90          |
|                        | Profilo labirinto centrale - anta mobile (Parte plastica)  | Central labyrinth profile - sliding sash (Pvc part)    | 2    | HT-82                 | 90 90          |
| GU1305L                | Profilo laterale porta guarnizione                         | Side profile for rebate gasket support                 | 4    | HT-42                 | 45 45          |
| GU1305T                | Profilo Pvc porta guarnizione sup./inf.                    | Upper/bottom profile for rebate gasket support         | 8    | LT/2-17               | 90 45          |
| GUM088                 | Profilo Pvc interfaccia anta profilo PAM088                | Profile between sash and profile PAM088                | 2    | LT/2-45               | 90 90          |
| <b>Fermavetri</b>      |  | <b>Glazing beads</b>                                   |      |                       |                |
| PR1007                 | Profilo fermavetro   | Glazing bead profile                                   | 4    | LT/2-88,5             | 90 90          |
|                        | Profilo fermavetro   | Glazing bead profile                                   | 4    | HT-180                | 90 90          |
| <b>Vetri</b>           |  | <b>Glass unit</b>                                      |      |                       |                |
|                        | Vetrocamera  | Double glazing   | 2    | (LT/2-104,5)x(HT-152) |                |
| <b>ACCESSORI</b>       |  | <b>HARDWARE</b>  |      |                       |                |
| Cod.                   | Descrizione  | Description  | n°   | Note/Notes            |                |
| AC1305G                | Guarnizione d'angolo vulcanizzata per GE1305S              | Vulcanised corner weather strip for GE1305S            | 4    |                       |                |
| AC1020XL               | Supporto spessore vetro                                    | Glass spacer   | 24   |                       |                |
| AC2993P                | Accessorio assiemaggio telaio                              | Frame assemblage accessory                             | var. |                       |                |
| AC1388R.xx             | Piatti di fissaggio carrelli su ante con profili ridotti   | Fixing plates for rollers on reduce profile            | 1    |                       |                |
| AC2618NE               | Scarico acqua per profilo contenimento pattini magnetici   | Water drain for or profile support for magnetic device | var. |                       |                |
| AC1363R                | Rinforzo giunzione d'angolo                                | Corner joint reinforcement                             | 8    |                       |                |
| ACM195                 | Accessorio assiemaggio profilo cont. pattini magnetici     | Accessory for profile support for magnetic device      | var. |                       |                |
| AG2992.AB              | Rostro aggiuntivo  | Additional hook bolt                                   | opz. |                       |                |
| CV5001.                | Viti per boccole fermavetro                                | Screw for glazing bead bushing                         | var. |                       |                |
| CV5012.                | Boccole per fermavetro                                     | Bushing for glazing bead                               | var. |                       |                |
| AGM386/7B.x            | Kit movimentazione e tenuta 2 ante apribili                | 2 leaf handling and sealing kit                        | 1    |                       |                |
| AC110RNE               | Kit squadrette di giunzione angoli Acciaio inox            | Corner joint Stainless steel                           | 1    |                       |                |
| AC110RNI               | Kit squadrette di giunzione angoli Acciaio inox            | Corner joint Stainless steel                           | 1    |                       |                |
| AC290SPI               | Kit giunzione angolo telaio                                | Frame corner joint kit                                 | 1    |                       |                |
| Vedi Pag. 2.5.1        | Maniglione   | Handle   | 2    |                       |                |
| <b>GUARNIZIONI</b>     |  | <b>GASKETS</b>   |      |                       |                |
| Cod.                   | Descrizione  | Description  | n°   | Dim.                  |                |
| GE1305S                | Guarnizione laterale e inferiore ante                      | Sash uproghts an bottom rail gasket                    | 1    | 4xHT + 2xLT           |                |
| GE1006                 | Guarnizione esterna vetro                                  | External gasket  | 1    | 4xHT + 2xLT           |                |
| GE1007TT               | Guarnizione sotto vetro                                    | Under glass gasket                                     | 1    | 4xHT + LT             |                |
| GE1011                 | Guarnizione interna vetro                                  | Internal glass gasket                                  | 1    | 4xHT + 2xLT           |                |
| GE1142                 | Guarnizione di tenuta labirinto                            | Labyrinth sealing gasket                               | 2    | HT                    |                |
| GE2905S                | Guarnizione superiore ante                                 | Top-rail gasket  | 2    | LT                    |                |
| GU0087+AD              | Spazzolino per labirinto + adesivo                         | Brush for corner joint + adhesive                      | 1    | HT                    |                |
| GU0087                 | Spazzolino per profilo contenimento pattini                | Brush for profile support for magnetic device          | 4    | LT                    |                |
| GUM020                 | Profilo spessoramento sotto vetro                          | Under glass profile                                    | 2    | LT/2                  |                |
| GU1311                 | Profilo Pvc compensazione                                  | Compensation Pvc profile                               | 2    | LT/2                  |                |
| GU1311R                | Profilo Pvc compensazione                                  | Compensation Pvc profile                               | 2    | HT-92                 |                |

\* Le dimensioni delle guarnizioni sono indicative e devono essere aumentate del 10% per adattamenti e ritiri del materiale nel tempo

CAPITOLO MOTORIZZAZIONE EBE 85 ØG  
*AUTOMATISATION CHAPTER EBE 85 ØG*



Schema | Type S1

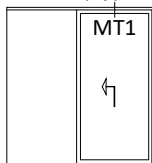

Schema | Type T1

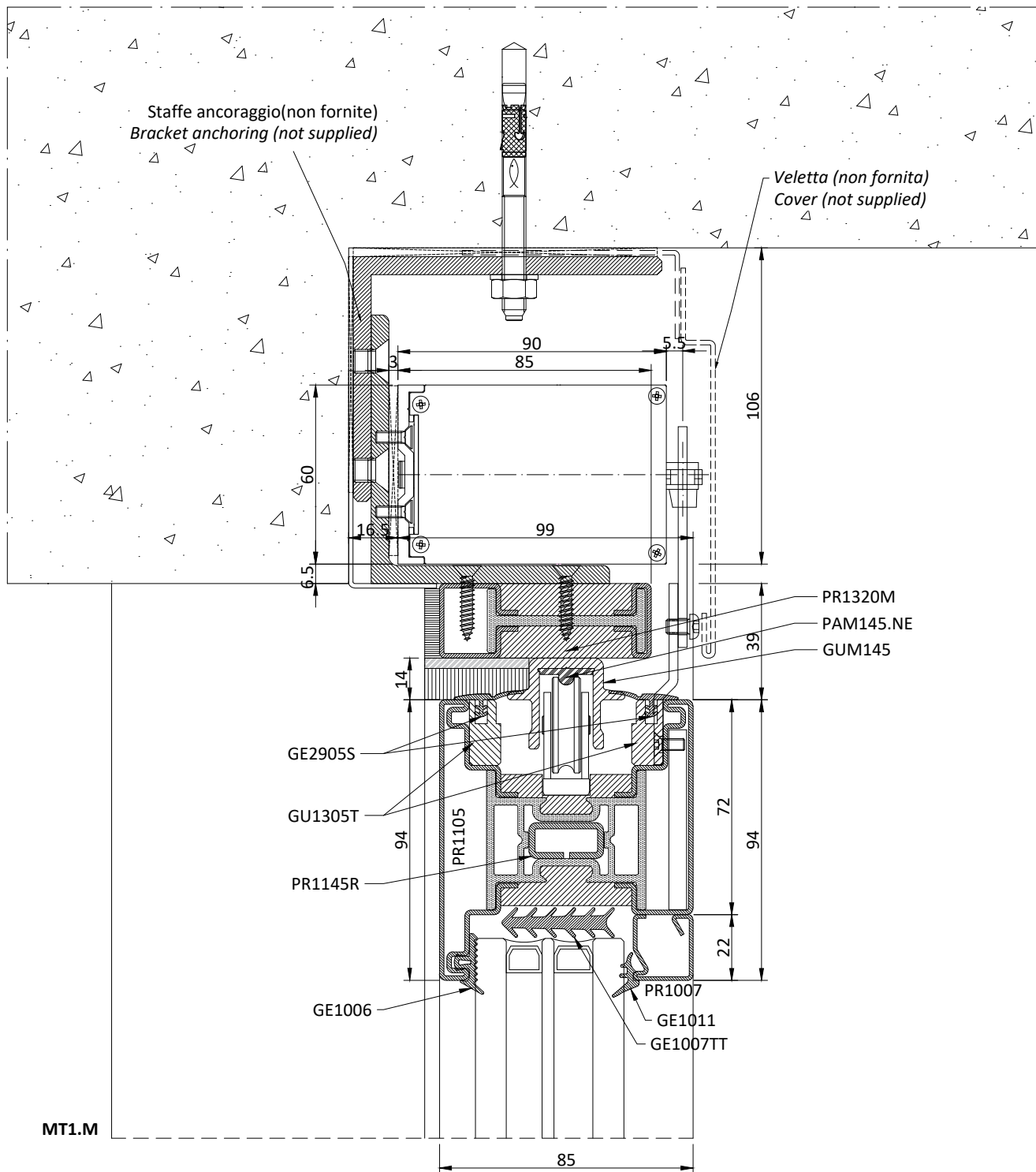
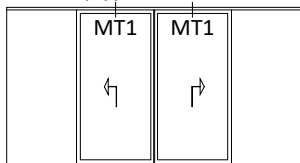

Schema | Type S1

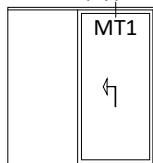

Schema | Type T1

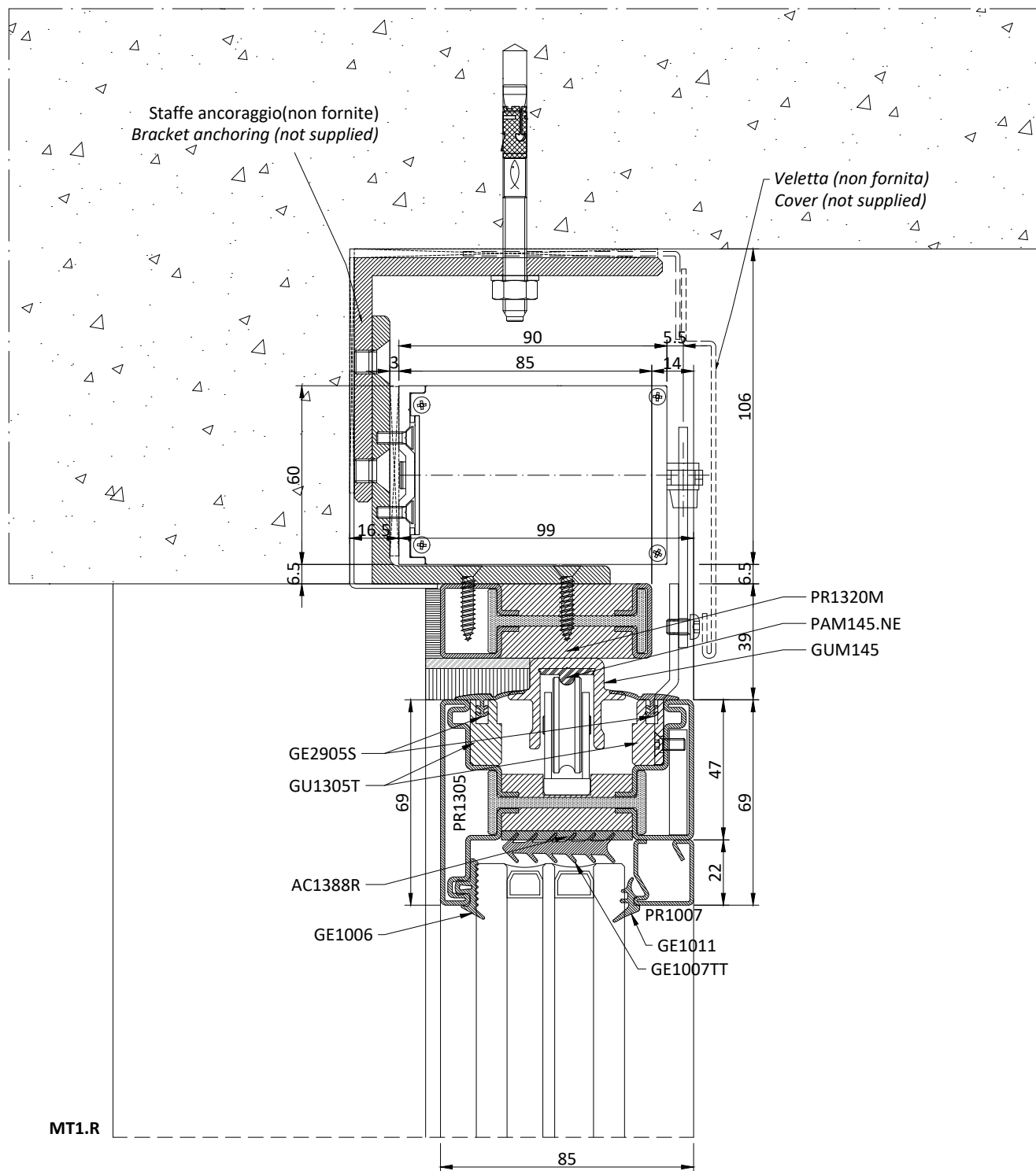
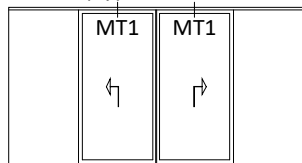

MT1.R

Schema | Type A

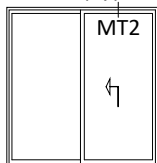

Schema | Type B

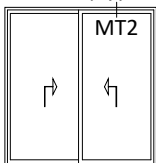

Schema | Type C

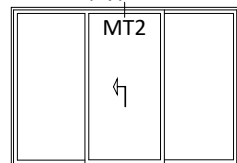

Schema | Type E

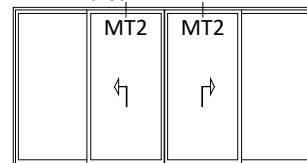

Schema | Type F

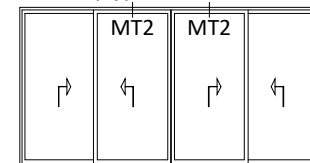

Schema | Type S2

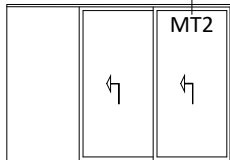

Schema | Type T2

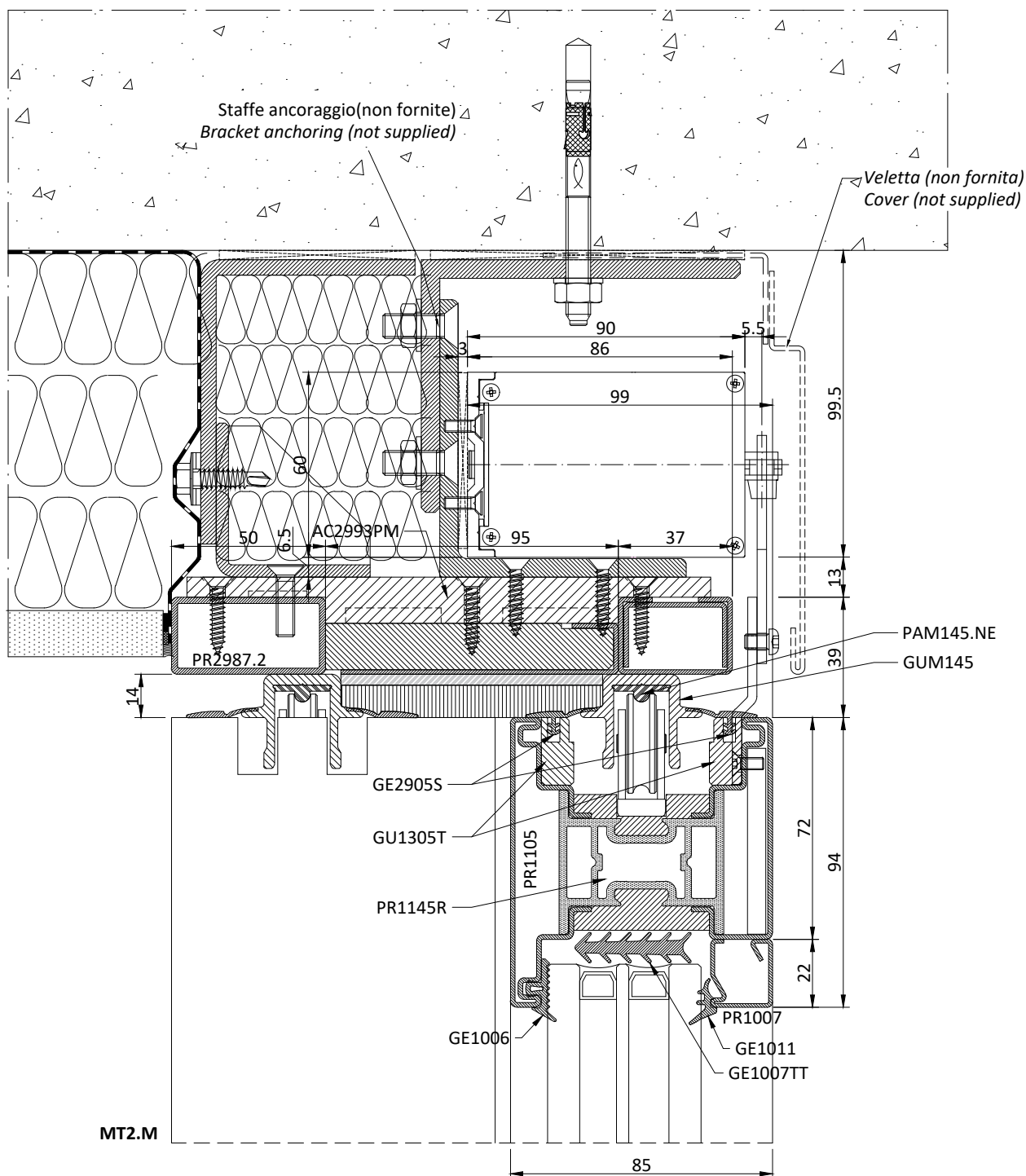
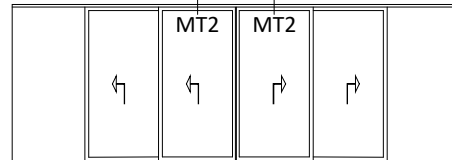

Schema | Type A

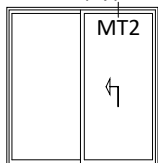

Schema | Type B

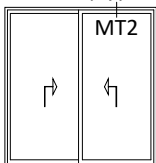

Schema | Type C

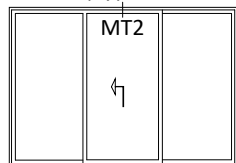

Schema | Type E

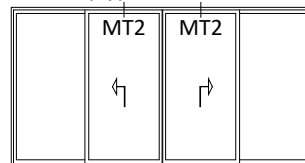

Schema | Type F

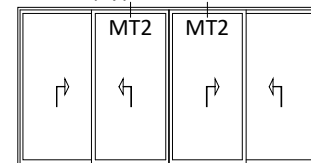

Schema | Type S2

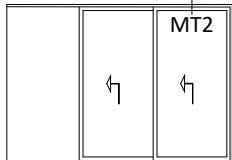

Schema | Type T2

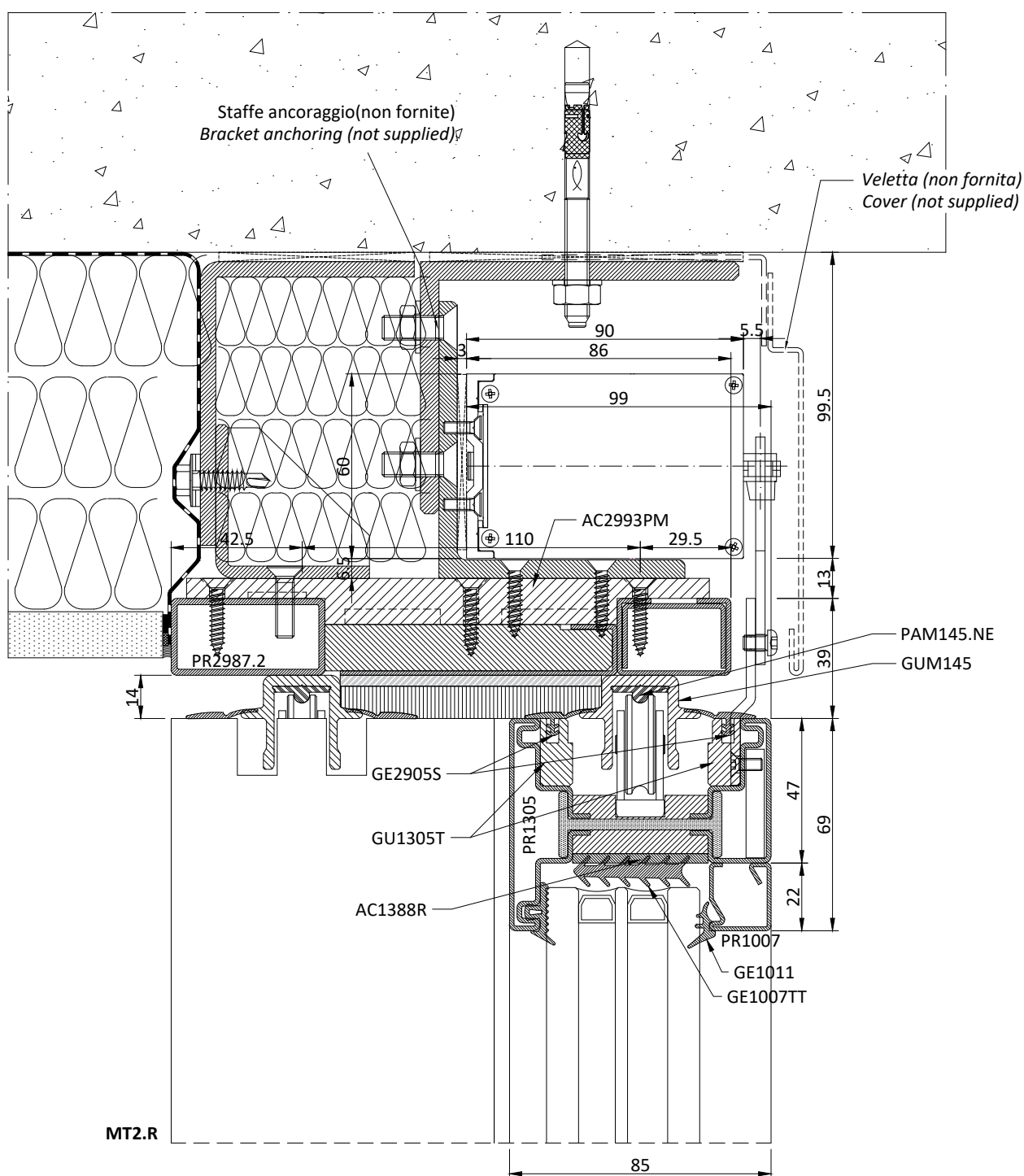
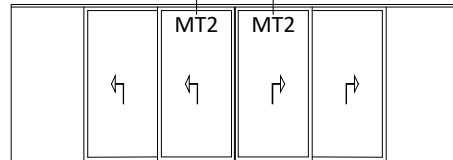

Schema | Type A3

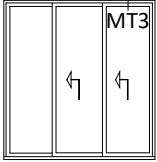

Schema | Type B3

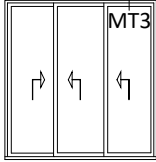

Schema | Type C3

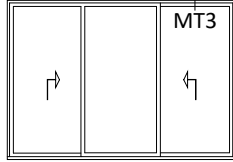

Schema | Type E3

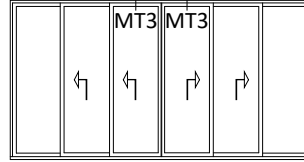

Schema | Type F3

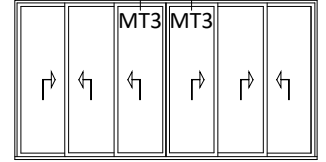

Schema | Type S3

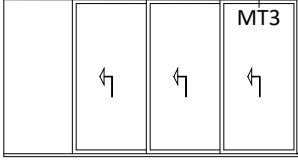

Schema | Type T3

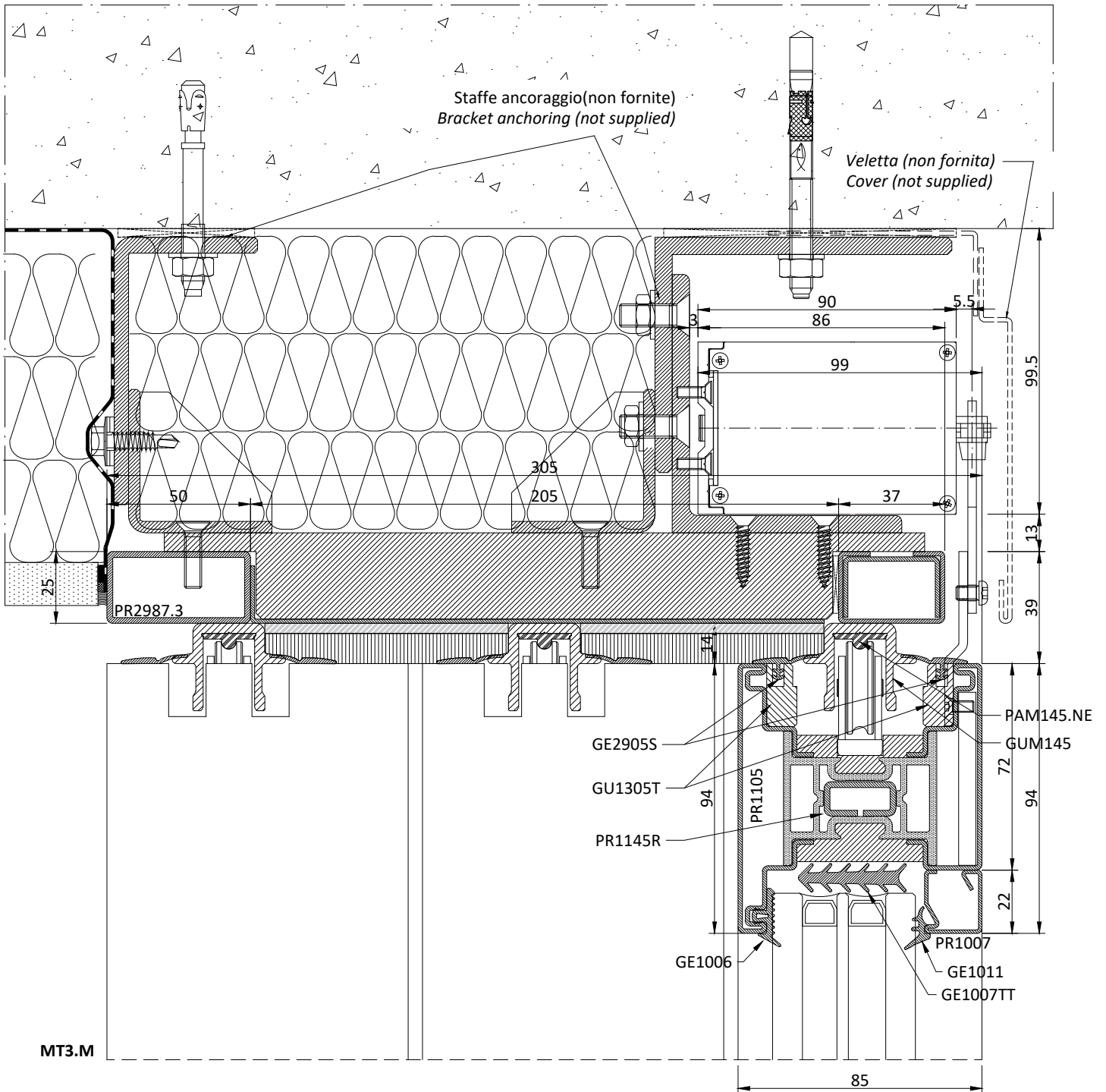
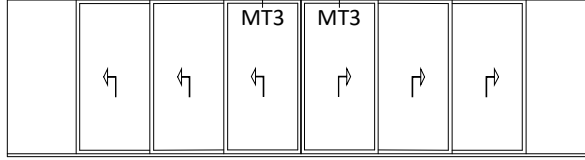

Schema | Type A3

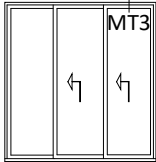

Schema | Type B3

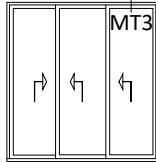

Schema | Type C3

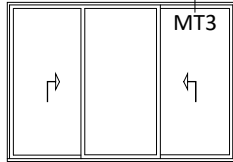

Schema | Type E3

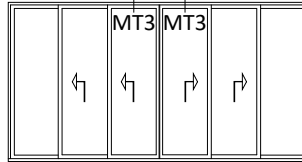

Schema | Type F3

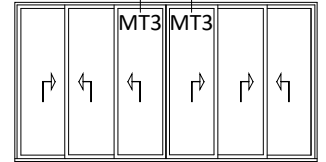

Schema | Type S3

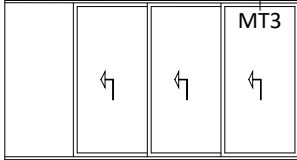

Schema | Type T3

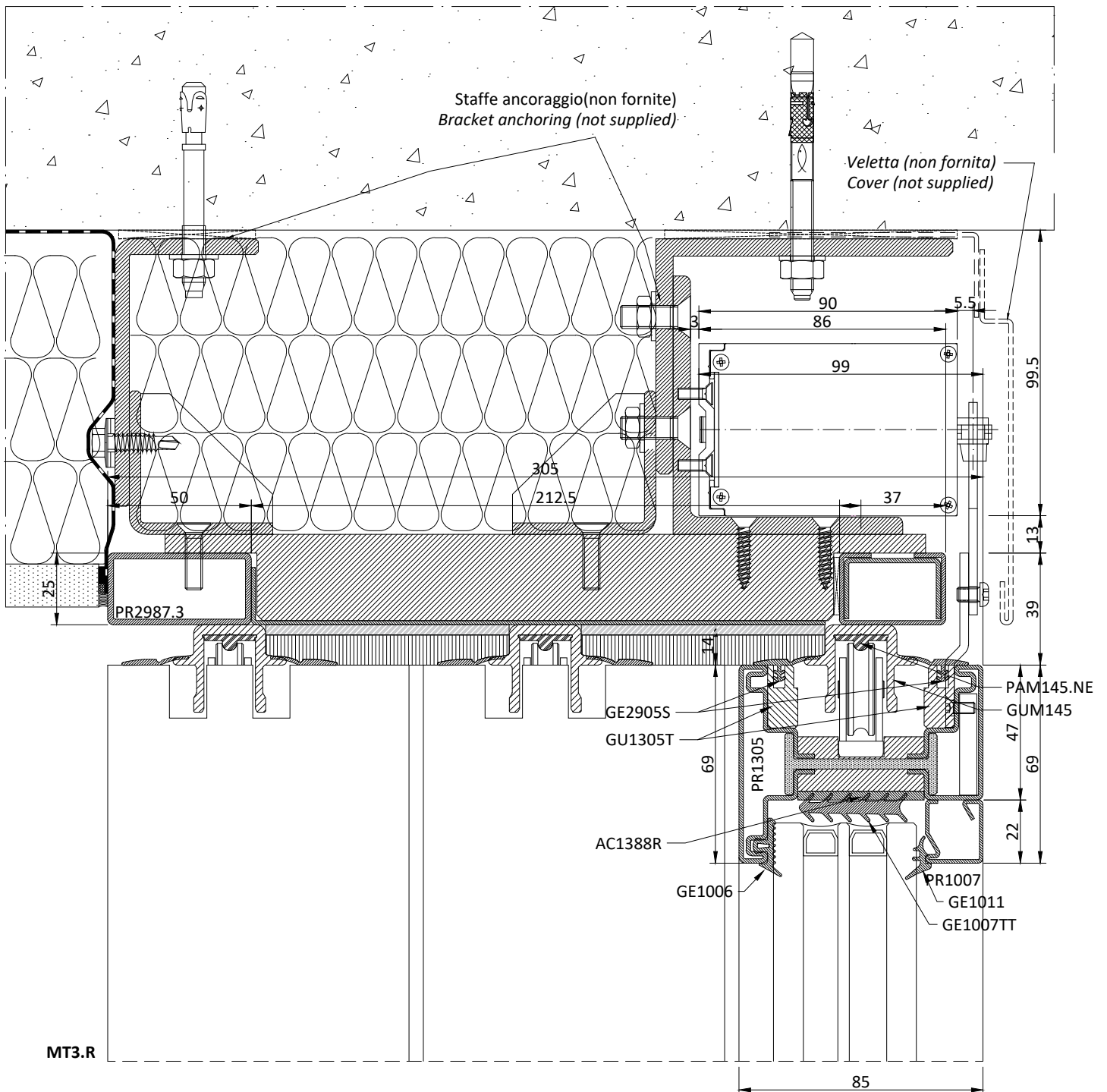
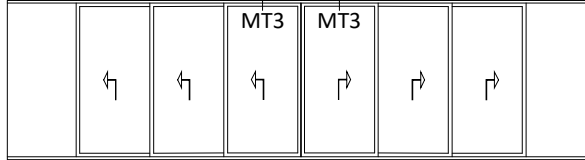

**Generalità**

I sistemi progettati e sviluppati dalla Secco Sistemi sono idonei per la fabbricazione di un'ampia gamma serramenti, vetrate e facciate in metallo. I sistemi sono rivolti ad aziende esperte e professionali nel campo della lavorazione dei metalli e della costruzione di serramenti e facciate, che sono a conoscenza delle normative di riferimento, delle direttive e delle specifiche tecniche del fornitore del sistema, nonché delle fondamentali regole dell'arte per la produzione e installazione di questi manufatti. Tutta la documentazione tecnica fornita costituisce un riferimento per i tecnici qualificati delle aziende al fine di indicare le modalità per la costruzione dei prodotti. In ogni caso i tecnici qualificati devono analizzare criticamente le indicazioni riportate per verificarne la loro adeguatezza per ogni singola commessa in relazione ai carichi, agli stress previsti e alle condizioni di messa in opera, essendo impossibile riportare in questa documentazione tutte le varianti riscontrabili nei progetti reali.

**Tolleranze**

EBE 85 ØG prevede l'accoppiamento tra i telai esterni e le ante apribili con distanza di 4 mm nei giunti laterali e di 3 e 14 mm nei giunti inferiore e superiore. Per garantire il corretto funzionamento degli accessori e delle guarnizioni le lavorazioni devono essere eseguite con particolare attenzione e precisione: si consiglia di mantenere la tolleranza per la dimensione degli elementi apribili compresa tra +0/-1 mm.

**Taglio/Lavorazioni**

I profili EBE 85 ØG in acciaio zincato, acciaio inox e corten possono essere tagliati con le normali troncatrici a disco utilizzate per i tubolari in acciaio, mentre per il taglio dei profili in ottone possono anche essere utilizzate troncatrici per le serie di alluminio. Vista la loro particolare dimensione e forma si consiglia di utilizzare le ganasce di taglio previste dal sistema per assicurare una perfetta stabilità dei profili durante il taglio. La verifica del taglio, sia per la sezione inclinata a 45° che per la sezione verticale a 90°, dovrebbe garantire una tolleranza compresa tra -1°/+1°. Tutte le lavorazioni devono essere eseguite con il rispetto della seguente nota tecnica ed eventuali modifiche concordate con l'ufficio tecnico Secco Sistemi.

**Saldatura**

I profili EBE 85 ØG possono essere saldati con i tradizionali sistemi di saldatura (MIG/MAG, TIG), con un idoneo sistema di lubrificazione/refrigerazione e utilizzando le istruzioni presenti nella presente nota tecnica ed evitando di saldare in prossimità della giunzione a taglio termico. L'eventuale riscaldamento del poliuretano libera sostanze gassose a base di aldeidi e CO: per tale ragione si consiglia di saldare con gli appositi DPI previsti e in zone con sufficiente areazione e in presenza di sistema per l'evacuazione dei fumi. I profili in corten devono essere saldati con apposito filo in corten mentre per i profili in ottone si può utilizzare un filo CuSi3. Si raccomanda di saldare in profondità e senza lasciare fori e porosità le aree in contatto, di lisciare e pulire adeguatamente la superficie saldata per garantire una corretta resistenza strutturale all'angolo e permettere una successiva verniciatura senza imperfezioni estetiche visibili (pori e ondulazioni).

**Verniciatura/Brunitura**

I profili EBE 85 ØG sono stati progettati per essere verniciati a polveri in forni con temperature di 180°C per 25 minuti. La zona a taglio termico in poliuretano non è in grado di accogliere con sufficiente adesione le polveri poliesteri e perciò si consiglia di ricoprire tali zone, nelle sole parti destinate ad essere in vista, con apposite pellicole adesive idonee al passaggio in forno.

I telai prima della verniciatura o della brunitura devono essere forati come da istruzioni presenti in questa nota tecnica per permettere la fuoriuscita dei liquidi utilizzati durante il pretrattamento delle superfici. All'uscita del forno di polimerizzazione della polvere i telai vanno rimossi accuratamente e adagiati in posizione piana sino al loro completo raffreddamento.

Si consiglia di seguire il ciclo di pretrattamenti e verniciatura presente nella documentazione Secco Sistemi.

**Vetrazione**

Il sistema di fissaggio del vetro prevede l'utilizzo di fermavetri agganciati all'interno tramite clips o boccole interne e mandati in pressione con l'incastro dell'apposita guarnizione interna; all'esterno è previsto l'utilizzo di una guarnizione perimetrale continua giuntata e sigillata in un angolo superiore o di una guarnizione butilica di fondo giunto e un cordolo di silicone applicato secondo le prescrizioni tecniche del fornitore del prodotto. Per il corretto funzionamento del sistema si suggerisce di verificare la perfetta compressione delle guarnizioni interne del fermavetro.

**Installazione**

La corretta installazione deve garantire il mantenimento delle performance dichiarate nella marcatura CE e testate in laboratorio. Si consiglia di progettare un corretto numero di fissaggi in relazione al tipo di controtelaio/muratura esistente e alle dimensioni degli elementi da installare. Al termine dell'installazione si verifichi il corretto funzionamento del serramento (facilità di apertura/chiusura, stabilità dell'anta aperta a riposo, etc.), il rispetto delle distanze tra ante apribili e telai fissi, il regolare posizionamento delle guarnizioni e delle sigillature e la mancanza di difetti estetici sulle superfici dei telai e del vetro.

**General information**

The systems designed and developed by Secco Sistemi are suitable for the manufacturing of a wide range of doors, windows and shutters, as well as faces or facades in metal. The systems are designed for professional and expert companies in the metal-working sector and that of construction of doors, windows, shutters and facades. These companies are well aware of the specific regulations and the directions and technical specifications of the system supplier, and also the fundamental rules of the art of manufacturing and installing these products. All the technical documentation provided furnishes a source of reference for the qualified technicians of the companies, giving indications as to how the products should be constructed. These qualified experts must critically analyse the indications to verify their adequacy for each single order in terms of load, stress and conditions of installation, particularly as this documentation cannot provide for all the different variations that may be found in projects.

**Tolerance**

EBE 85 ØG is made by coupling external frames with the opening leaves with a distance of 4 mm in lateral joint and 3 mm or 14 mm in the lower and upper joint. To ensure the correct functioning of hardware and gaskets, tooling must be performed with great care and precision. It is advised to keep the tolerance between +0/-1 mm for opening elements.

**Cut / Processing**

EBE 85 ØG profiles in galvanized steel, stainless steel and corten steel can be cut with normal saws, like those used for steel pipes. EBE 85 ØG profiles in brass can be cut with saws used for aluminium. Given their dimension and size, it is recommended to use the cutting jaws advised to ensure perfect stability during the cutting procedure. In order to verify the correctness of the cut, the tolerance of both the 45° and the 90° sections must be between -1°/+1°. All Tooling must be performed in line with this technical note and any variations agreed with Secco Sistemi's Technical Department.

**Welding**

EBE 85 ØG profiles can be welded with the traditional systems (MIG/MAG, TIG), with an appropriate lubricating/cooling system and according to the instructions as per this technical note. Avoid welding near the thermal break joint. Heating any polyurethane items releases gaseous substances containing aldehydes and CO. For this reason it is recommended to weld with the special Personal Protective Equipment suggested and in areas with sufficient ventilation and fume-disposing systems. The corten profiles must be welded with special corten wire, while for profiles in brass a CuSi3 wire can be used. It is recommended to weld in depth, to avoid leaving any holes or porosity on the surfaces and to smooth and clean the welded surface thoroughly. This is to guarantee a proper structural resistance at the corner and to allow for later painting without any visible imperfections (pores and ripples).

**Painting/Burnishing**

EBE 85 ØG profiles have been designed to be painted with the powder coating technique in industrial ovens at temperatures of 180°C for 25 minutes. The thermal break area is not designed to absorb polyester powders and therefore it's advised to cover the visible areas with appropriate industrial-oven-resistant adhesive films (SA1024 and SA1033). Holes must be drilled in the frames (as per instructions in these technical specifications) before painting or burnishing in order to allow drainage of any liquid used as a pre-treatment of the surfaces. Once out of the oven, the frames must be accurately removed and laid in a horizontal position until complete cooled.

It is advised to follow pre-treatment and painting cycles as outlined in the Secco Sistemi documentation.

**Glass application**

Glass needs to be secured internally and externally. Internally, glazing beads must be used together with clips or bushings and then secured by pressure with the appropriate gasket; externally a continuous perimetrical gasket should be applied, jointed and sealed in a top corner or a butyl seal and a thread of silicone that must be applied according to the product supplier's technical specifications. In order to ensure the correct functioning of the system, it is recommended to verify the proper pressurization of the internal glazing bead gaskets.

**Installation**

Proper installation must guarantee that the performances declared in the EC marking and verified in the lab will remain constant. It is advised to arrange a correct series of set ups with reference to the existing type of subframe/brickwork and to the dimensions of the elements to install. Once installation is completed, the proper functioning of the window/door (easiness of opening/closing, stability of the open leaf, etc.), should be tested as well as the correctness of joints and overlapping areas between opening leaves and fixed frames, the proper positioning of gaskets and seals, the drainage of frames with weep system and the absence of any aesthetic defects on the frame and glass surfaces.



**Troncatrice**caratteristiche minime della macchina

- Potenza: 1.8 – 2.5 kW;
- Possibilità di taglio a 45° nei due sensi e a 90°;
- Velocità di taglio ideali: 15-30 giri/min per acciaio inox;  
60-90 giri/min per acciaio zincato e corten,  
90 giri/min o superiori per bronzo (OT/67);
- Capacità di taglio: 150 x 80 mm a 90°;  
100 mm taglio a 45°.

caratteristiche della lama

- Lama da 350 mm con spessore 2.5 mm;
- N° denti: 300 per tagli a 45°;  
350 per tagli a 90°;
- Materiale: HSS (verificare materiali di commercio con finiture che migliorano la durata delle lame).

NB: è possibile tagliare la lega OT/67 con le stesse macchine dell'alluminio.

**Pantografo**caratteristiche minime della macchina

- Mandrino con velocità regolabile 2000-11000 giri/min (per un corretta lavorazione su acciaio inox è necessario operare a n° ridotto di giri < 4000);
- Struttura in ghisa adatta al taglio acciaio;
- Testata pesante per limitare le vibrazioni;
- Chiusura del profilo da lavorare con morse.

caratteristiche minime delle frese

- Materiale: HSS (verificare materiali di commercio con finiture che migliorano la durata delle frese);
- Frese a 4 denti;
- Frese con diametro 5 mm per le lavorazioni di scasso.

**Forature**montaggio componenti di chiusura e movimentazione sui profilati in acciaio inox

- Forare con punte da trapano HSS del diametro indicato sulla corrispondente tavola tecnica;
- Maschiare il foro con vite autofilettante zincocromata avente diametro corrispondente alla vite inox fornita nel kit con l'articolo da montare;
- Posizionamento e fissaggio definitivo dell'articolo con le viti inox in dotazione.

fresatura di cave e asole sui profili inox

- Adoperare macchine (pantografi o fresatrici) adeguate alle lavorazioni dell'acciaio;
- Regolazione del numero di giri max (3000 giri/1');
- Impiego di frese di diametro massimo di 8mm a 4 pale in acciaio HSS;
- Abbondare con la lubrificazione, concentrata sull'utensile;
- Ridurre l'avanzamento fino ad accertare un taglio il più regolare possibile;
- È normale un'usura accelerata dell'utensile.

**Cutter**Minimum requirements for the use of the machine

- Power: 1.8 – 2.5 kW;
- Possibility of cutting at 45° in both directions and at 90°;
- Ideal cutting speed: 15-30 rmp for stainless steel;  
60-90 rmp for galvanised and corten steel;  
90 rmp or higher for bronze (OT/67);
- Cutting capability: 150 x 80 mm at 90°;  
100 mm cut at 45°.

Blade specifications

- 350 mm blade with a 2.5 mm thickness;
- Number of teeth: 300 for 45° cut;  
350 for 90° cut;
- Material: HSS (please verify availability of longer lasting material on the market).

Note: OT/67 alloy can be cut with machines made for aluminum.

**Phantograph**Minimum requirements for the use of the machine

- Mandrel with a 2000-11000 rmp adjustable speed (for a proper stainless steel processing a slower speed is required i.e.<4000 rpm);
- Machine should be made of cast iron suitable for steel cutting;
- Heavy head in order to limit vibrations;
- Secure the profile to be processed in jaws.

Minimum requirements for the use of a milling machine

- Material: HSS (please verify availability of longer lasting material on the market);
- Use a 4-tooth milling machine;
- Use a milling machine with a 5-mm diameter for groove processing.

**Drilling**How to mount closing and moving components on a stainless steel profile

- Use a HSS drill. The diameter of the drill is indicated in the technical note;
- Thread the hole with self-threading zinc-plated screws with the same diameter as the stainless steel screw provided with the kit;
- Position and secure the item with the stainless steel screws provided.

Milling slots and loops in the profiles

- Use machines designed for steel processing (pantographs or milling machines);
- Max rpm setting (3000 rpm);
- Use milling machines with a diameter no bigger than 8 mm and with 4 HSS steel blades;
- Exceed with lubrication, mainly on the machine;
- Processed slowly until the milling is as clean as possible;
- Expect a fast wearing of the machine.

1. Controllo materiale in arrivo / *Incoming equipment Control*

Verifica visiva dell'intergrità delle barre con attenzione a: / *Profiles wholeness visual control paying attention to:*

- Strisci profondi / *Deep scratches* verifica visiva / *visual control*
- Botte e avvallamenti sulla superficie / *Bumps and dips on surface* verifica visiva / *visual control*
- Rettilineità barre / *Profiles straightness tolerance* 0,002 x L
- Svergolamento / *Profiles twist tolerance* 1° x m

2. Taglio barre e controllo barre / *Cut and Control of profiles*

- Misura lunghezza / *Length measurement* ±0.5 mm
- Verifica 45° / *45° Control* ± 1°
- Verifica 90° / *90° Control* ± 1°

**MATERIALI****ACCIAIO INOX****Materiale**

Profilati ricavati da nastro di lamiera di acciaio inox laminato a freddo pre-trattato industrialmente per garantire la massima qualità e uniformità.

**Caratteristiche fisiche**

AISI 316L Marino (X2 CrNiMo 17-12-2)

**Norme di riferimento**

EN 10088-2; EU 114

**Trattamenti superficiali**

Finitura satinata: ottenuta su nastro AISI 304 con finitura superficiale 2B con successiva satinatura con abrasivi a grana 240-280.

Finitura lucida: ottenuta su nastro AISI 316L (marino) con finitura superficiale 2R, riflettività 53% e successiva lucidatura a specchio.

Finitura Scotch Brite: ottenuta su nastro AISI 316L (marino) con finitura superficiale 2B con successiva spazzolatura Scotch Brite.

**ACCIAIO COR-TEN****Materiale**

Profilati ottenuti da nastro in acciaio altoresistenziale, autopassivante (che un tempo veniva commercializzato con il nome Cor-Ten) tale da formare, se esposto all'aria, uno strato di ossido uniforme e stabile che, ricoprendo la lamiera, ne arresta la corrosione atmosferica.

**Caratteristiche fisiche**

Fe 510 X (C max % 0,12; Si % 0,25-0,75; Mn % 0,20-0,50; P % 0,07-0,15; Cu % 0,25-0,55; Cr % 0,30-1,25; Ni max % 0,65)

**Norme di riferimento**

EN 10149

**Trattamenti superficiali**

Dopo la profilatura il materiale viene immerso in speciali bagni ossidanti tali da accelerare la formazione dello strato protettivo. Raggiunta la tonalità desiderata della superficie si procede ad una ceratura di stabilizzazione del materiale.

**ACCIAIO ZINCATO VERNICIATO****Materiale**

Profilati ottenuti da nastro in lamiera di acciaio zincato a caldo sistema Sendzimir finitura skinpassata

**Caratteristiche fisiche**

FeP02 GZ 200 (copertura di zinco pari a 200gr/m<sup>2</sup> per faccia)

**Norme di riferimento**

UNI EN 10142/3/7; EURONORM 143

**Trattamenti superficiali per la verniciatura**

La preparazione del supporto zincato si effettua tramite i processi di sgrassaggio, decapaggio e lavaggio in acqua. Segue l'applicazione di uno strato di zinco per fosfatazione seguito da lavaggi in acqua demineralizzata. Infine applicazione della mano a finire con polveri poliestere cotte in forno a 180 °C per 25 minuti.

**LEGA DI RAME OT67****Materiale**

Profilati ottenuti da nastro di Lega di Rame OT67 laminato a freddo rincrudito allo stato grezzo.

**Caratteristiche fisiche**

Cu Zn 33 CW 506L (OT 67, 67% rame)

**Norme di riferimento**

EN 1652:1999

**Trattamenti superficiali**

Finitura brunita: dopo la profilatura viene eseguita una ricottura di distensione, quindi la pulitura meccanica con abrasivo e la successiva brunitura per immersione con liquido brunitore; il profilo viene poi lavato e asciugato ed infine protetto mediante trattamento con olio di vaselina.

Finitura lucida: dopo la profilatura viene eseguita una ricottura di distensione e successivamente la lucidatura a specchio.

**MATERIALS****STAINLESS STEEL****Materials**

Sections processed out of the cold-rolled coils, industrially pre-treated for utmost quality and uniformity.

**Physical features**

AISI 316L Marino (X2 CrNiMo 17-12-2)

**Norms of reference**

EN 10088-2; EU 114

**Surface treatment**

Satined: obtained on AISI 304 coil 2B pre-finish with post-treatment by means of abrasive 240-280 in grain size.

Polished: obtained on AISI 316L (marine) coil pre-finish with 2R surface finish, 53% reflectivity, and mirror post-polish.

Scotch Brite: obtained on AISI 316L (marine) coil 2B pre-finish with Scotch-Brite post-scrubbing.

**CORTEN STEEL****Materials**

Sections processed out of highly resistant self-oxidising steel coils – once traded under the name Cor-Ten. If exposed to the open air, it produces a uniform protective layer that reduces weather corrosion.

**Physical features**

Fe 510 X (C max % 0,12; Si % 0,25-0,75; Mn % 0,20-0,50; P % 0,07-0,15; Cu % 0,25-0,55; Cr % 0,30-1,25; Ni max % 0,65)

**Norms of reference**

EN 10149

**Surface treatment**

After forming, sections are plunged into a special oxydising bath to catalyze formation of the protective coating. Once the desired tone obtained, sections are stabilized by a wax coating.

**GALVANIZED AND PAINTED STEEL****Materials**

Sections processed out of hot galvanized steel coils, band "Sendzimir, skinpassed finishing.

**Physical features**

FeP02 GZ 200 (with zinc coating of 200 gr/sq x m on both faces)

**Norms of reference**

UNI EN 10142/3/7; EURONORM 143

**Pre-painted surface treatment**

The preparation of a galvanised surface is made through several processes: degreasing, pickling and washing. A coating of zinc is then applied through a phosphatising process followed by rinses in demineralised water. A final coat is then applied with polyester powders baked at 180 °C for 25 minutes.

**COPPER ALLOY OT67****Materials**

Sections processed out of copper alloy coils, industrially cold-rolled.

**Physical features**

Cu Zn 33 CW 506L (OT 67, 67% copper e 33% zinc)

**Norms of reference**

EN 1652:1999

**Surface treatment**

Burnished finish: after forming, the product is submitted to stress relieving, then to mechanical cleaning with abrasive products and ultimately to burnishing by plunging into a burnishing solution. It is then washed and dried and protected with a vaseline coating.

Glossy finish: after forming, the product is submitted to stress relieving and then mirror-like polished.





# METALFORM

**MASTERS OF METAL**

**UNITED KINGDOM**

**METALFORM**

**NORWAYMETAL LTD**

53 Chelsea Manor Street

London, SW3 5RZ

**SALES@METALFORM.UK**

**+44 20 81298814**

**GERMANY**

**METALFORM GMBH**

Carl-Zeiss-Ring 15A

85737 Ismaning

**SALES@METALFORMGROUP.DE**

**+49 17663630406**

**NORWAY**

**METALFORM AS**

Brochmannsveien 2

1950 Rømskog

**SALG@METALFORM.NO**

**+47 401 62 446**

**METALFORMGROUP**

**SALES@METALFORMGROUP.COM**